

# DESIGN STUDY REPORT

## **Parks Highway MP 305-325 Reconstruction**

**0A45028/Z606570000**

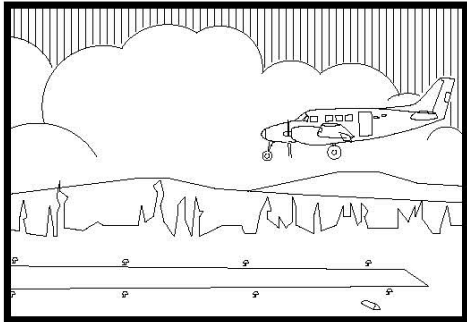

# STATE OF ALASKA

Department of Transportation  
and Public Facilities

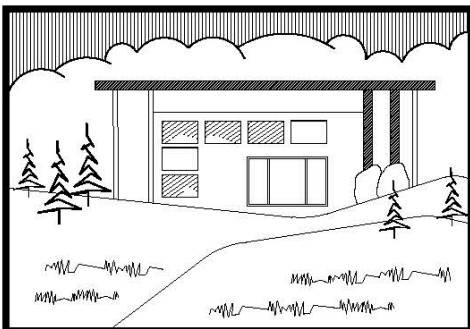
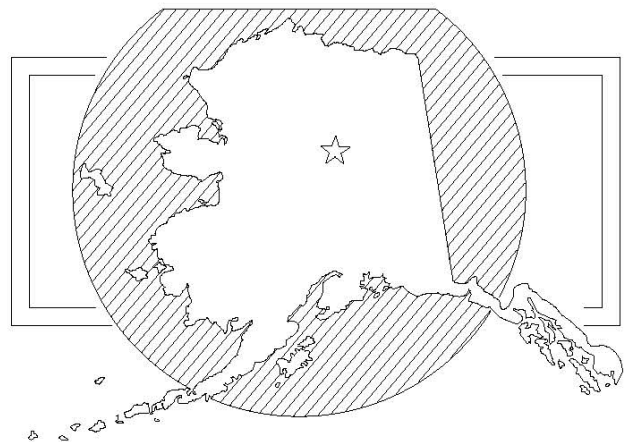
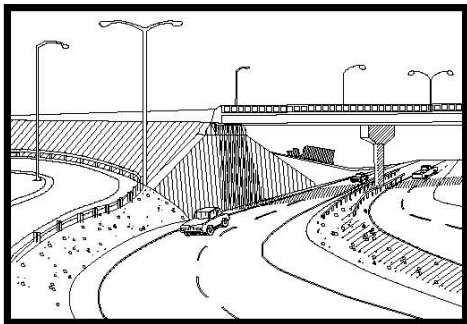

*NORTHERN REGION*

*February 2020*

DESIGN APPROVAL

PARKS HIGHWAY MP 305-325 RECONSTRUCTION

PROJECT NO. 0A45028/Z60657000

Requested by:  02/23/2020

---

Jennifer J. Wright, P.E.  
Engineering Manager  
Northern Region

Date

Design Approval  
Granted:  2/28/2020

---

Sarah E. Schacher, P.E.  
Preconstruction Engineer  
Northern Region

Date

Distribution: NR Design Directive 20-01 Distribution



DESIGN STUDY REPORT  
FOR

PARKS HIGHWAY MP 305-325 RECONSTRUCTION

PROJECT NO. 0A45028/Z606570000

PREPARED BY: RaeAnne E. Hebnes, P.E.



ALASKA DEPARTMENT OF TRANSPORTATION AND PUBLIC FACILITIES  
NORTHERN REGION DESIGN AND ENGINEERING SERVICES  
FEBRUARY 2020

PARKS HIGHWAY MP 305-325 RECONSTRUCTION  
PROJECT NO, 0A45028/Z606570000

**Table of Contents**

INTRODUCTION/HISTORY .....	1
PROJECT DESCRIPTION.....	3
DESIGN EXCEPTIONS AND DESIGN WAIVERS.....	5
DESIGN ALTERNATIVES.....	6
PREFERRED DESIGN ALTERNATIVE .....	13
3R ANALYSIS .....	15
TRAFFIC ANALYSIS .....	15
HORIZONTAL/VERTICAL ALIGNMENT .....	16
TYPICAL SECTIONS.....	18
PAVEMENT DESIGN .....	19
PRELIMINARY BRIDGE LAYOUT.....	19
RIGHT-OF-WAY REQUIREMENTS .....	20
MAINTENANCE CONSIDERATIONS.....	23
MATERIAL SOURCES.....	23
UTILITY RELOCATION AND COORDINATION.....	24
ACCESS CONTROL FEATURES .....	24
PEDESTRIAN/BICYCLE (ADA) PROVISIONS.....	24
SAFETY IMPROVEMENTS.....	25
INTELLIGENT TRANSPORTATION SYSTEM FEATURES.....	25
DRAINAGE.....	25
SOIL CONDITIONS .....	27
EROSION AND SEDIMENT CONTROL .....	28
ENVIRONMENTAL COMMITMENTS.....	29
WORK ZONE TRAFFIC CONTROL .....	30
VALUE ENGINEERING.....	30
CONSTRUCTION PHASING .....	30
COST ESTIMATE.....	32
PROJECT LOCATION .....	Figure 1
PROJECT VICINITY MAP .....	Figure 2
PROJECT LAYOUT PLAN.....	Figure 3
ALTERNATIVE ALIGNMENT COMPARISON MP 325-315.....	Figure 4
ALTERNATIVE ALIGNMENT COMPARISON MP 315-305.....	Figure 5
PARKS HIGHWAY TYPICAL SECTION (FILL) .....	Figure 6
PARKS HIGHWAY TYPICAL SECTION (CUT) .....	Figure 7
PARKS HIGHWAY TYPICAL SECTION (EXCESS MATERIAL PLACEMENT) .....	Figure 8
M320-324 RIGHT OF WAY ACQUISITION .....	Figure 9
MP 316-317 RIGHT OF WAY ACQUISITION.....	Figure 10
MASS HAUL VS CONSTRUCTION COST .....	Figure 11

DESIGN CRITERIA AND DESIGN DESIGNATION .....	Appendix A
ENVIRONMENTAL DOCUMENT .....	Appendix B
TRAFFIC ANALYSES .....	Appendix C
PAVEMENT DESIGN .....	Appendix D
PRELIMINARY PLAN AND PROFILE SHEETS .....	Appendix E
PRELIMINARY BRIDGE PLANS.....	Appendix F
DESIGN EXCEPTION AND DESIGN WAIVER REQUEST .....	Appendix G
REFERENCED REPORTS .....	Appendix H

## **INTRODUCTION/HISTORY**

The Alaska Department of Transportation and Public Facilities (Department), proposes to reconstruct the Parks Highway from milepost (MP) 305 to MP 325. Improvements include upgrading the horizontal and vertical geometry to meet current design standards, replacing the Little Goldstream Creek Bridge No. 678, improving and adding truck lanes, and adding passing lanes.

The project will enhance safety and operations for all users. The project area experiences a high volume of commercial traffic as the primary overland route between Alaska's two largest cities, Anchorage and Fairbanks, and an extension of the Dalton Highway route to the North Slope from the Port of Anchorage. It also serves as a tourist corridor for the Denali National Park and Preserve and other scenic interests and is a Scenic Byway. The Parks Highway experiences increased traffic volumes throughout the summer months due to seasonal activities like construction and tourism.

Currently, approximately half of the existing geometry in the project limits does not meet current design standards, and the pavement and Little Goldstream Creek Bridge No. 678 are nearing the end of their useful life. Reconstructing this section of the highway will improve corridor safety and traffic operations by improving roadway geometry, adding and upgrading passing and truck lanes, and replacing Little Goldstream Creek Bridge No. 678 with a wider bridge to accommodate 8-foot (ft) shoulders for improved bicycle and pedestrian provisions. Maintenance and operations (M&O) will be improved with the proposed roadway geometry, addition and relocation of pull-outs, improved drainage, and reconstructed pavement structural section.

See Figure 1 and Figure 2 for the Project Location Map and the Project Vicinity Map.

Figure 1: Project Location Map

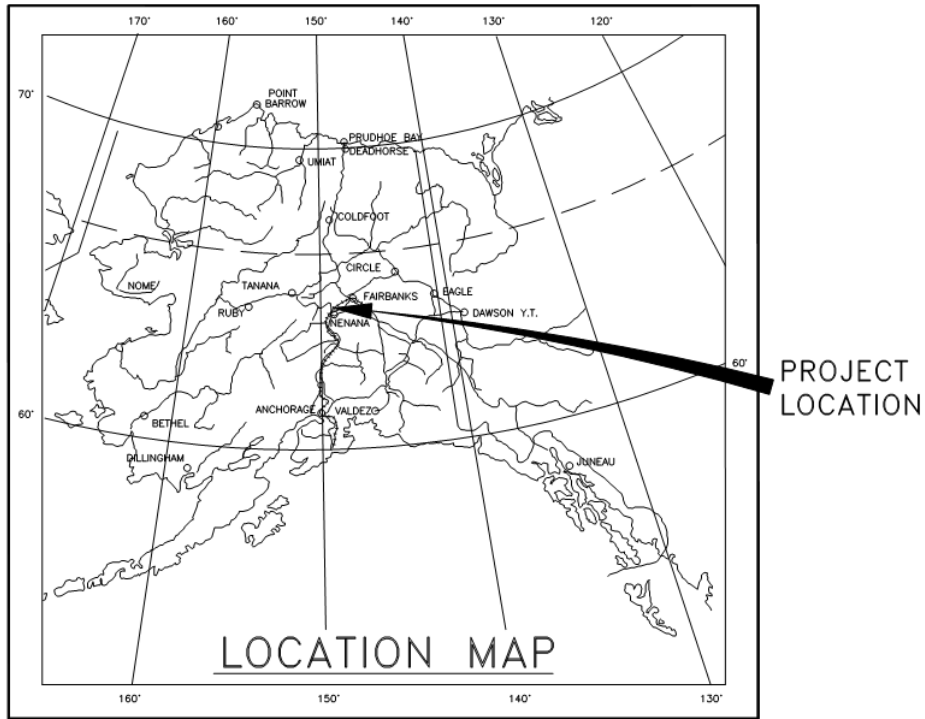
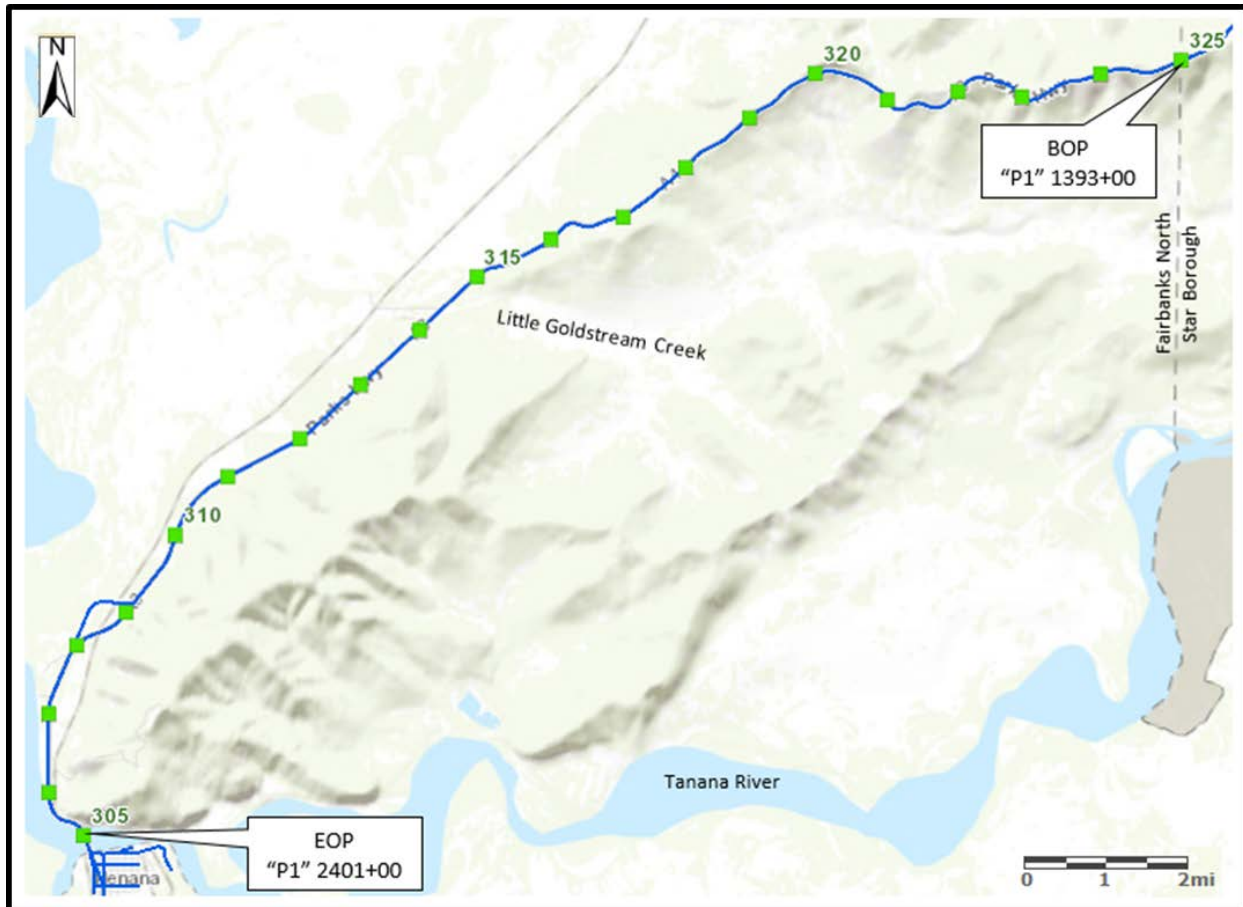

Figure 2: Project Vicinity Map



The Parks Highway in the project area was upgraded in 1967 from the original Nenana-Fairbanks highway (~1950's era construction). It was rehabilitated and paved with truck climbing lanes added in 1985. Since then, there have been two Highway Safety Improvement (HSIP) funded projects linked to the deficient curves in the MP 321 area for enhanced signage. Beyond the HSIP projects and occasional M&O projects such as crack sealing, the project corridor has remained largely unimproved since the 1985 construction. The existing paved surface is in poor condition and there are insufficient cross culverts starting around MP 319 that lead to failed pavement areas and sediment in the ditches. The Little Goldstream Creek Bridge No. 678 is structurally deficient and functionally obsolete.

## **PROJECT DESCRIPTION**

The Parks Highway MP 305-325 Reconstruction Project is located between the Tanana River Slough Bridge at Nenana (MP 305) and the Fairbanks North Star Borough boundary (MP 325). The purpose of this project is to upgrade this Interstate corridor to improve safety and enhance commercial and recreational function.

Existing safety and operational deficiencies within the project area include the following:

- Sub-standard curves and grades
- Insufficient southbound passing opportunities
- Insufficient sight distance at turnouts and driveways
- Failing, cracked, and rutted pavement
- Seasonal load restrictions
- Little Goldstream Creek Bridge No. 678 is structurally deficient and functionally obsolete.

The project goals are to:

- Improve safety
- Improve traffic operations
- Enhance commercial and recreational function
- Reduce M&O costs and improve M&O functionality

The proposed project will realign the Parks Highway to meet current design standards, add or improve passing and truck lanes, improve drainage by installing and replacing culverts and improve ditching, construct new turnouts, improve sight distance at intersections, and replace the Little Goldstream Creek Bridge No. 678.

The total project length is 19.09 miles. See Figure 3 for the project layout plan.



LEGEND

<b>LAND STATUS</b>	<b>SLOPE LIMITS</b>
STATE LAND	NEW ROAD
STATE LAND FOREST	CUT/FILL AREA
NATIVE LAND	RIGHT-OF-WAY
NATIVE ALLOTMENT	

SCALE: 1" = 1 MILE

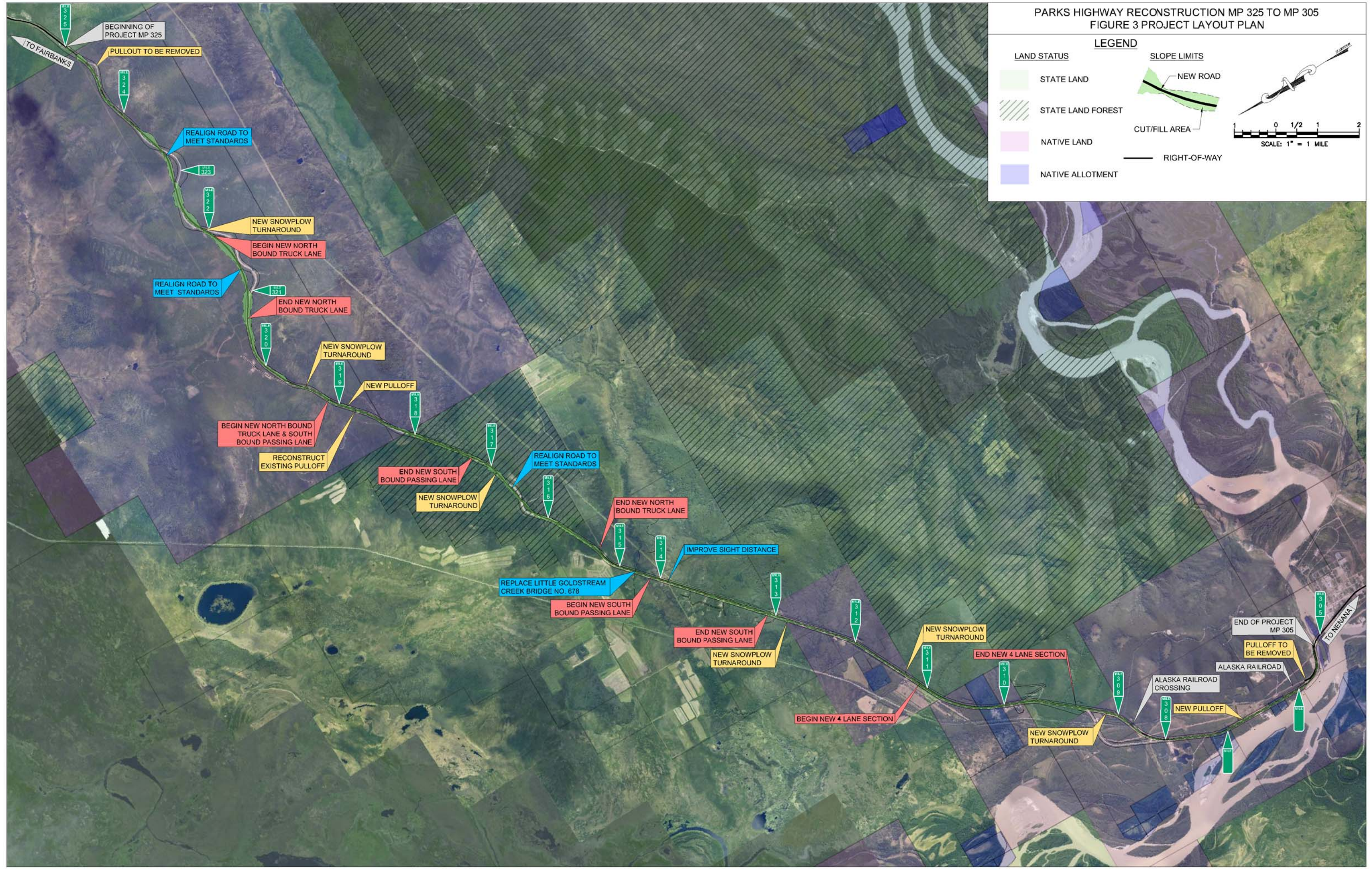



## **DESIGN STANDARDS**

The design standards followed for this project include:

- *A Policy on the Geometric Design of Highways and Streets* (GB), 2011, American Association of State Highway and Transportation Officials (AASHTO).
- *Alaska DOT&PF Highway Preconstruction Manual* (PCM), State of Alaska, Department of Transportation & Public Facilities (ADOT&PF).
- *Alaska Flexible Pavement Design Manual*, 2004, ADOT&PF, and associated software.
- *Alaska Traffic Manual* (ATM), 2016, ADOT&PF.
- *Alaska Highway Drainage Manual*, 2006, ADOT&PF.
- *Roadside Design Guide*, 2011, AASHTO.

A design speed of 70 miles per hour (mph) was selected in accordance with GB and PCM guidance. The functional classification of the Parks Highway in this area is rural Interstate with level to mountainous terrain. See Appendix A for design criteria and design designation.

## **DESIGN EXCEPTIONS AND DESIGN WAIVERS**

The project will require two design exceptions for stopping sight distance and three design waivers for vertical curves near the beginning of project from Station 1395+00 to Station 1455+00. This stationing falls between MP 323.5 to 325. This segment is characterized by steep grades, sharp curves, and a mixture of commercial, commuter, and tourist traffic. Design exceptions and waivers are needed to maintain the existing alignment and avoid substantial reconstruction of the existing corridor. The design exceptions will reduce the minimum stopping sight distance from 730 ft (GB) to 470 ft. The design waivers will reduce the minimum K value for crest curves from 247 (GB) to 98 and for the sag curve from 181 (GB) to 111.

Attempting to meet standards for vertical curvature and stopping sight distance would increase excavation by 150,000 CY resulting in added cost of \$1.35 million associated with additional excavation and lane shifts during construction to change the elevation by 12 ft. Existing crash data does not support upgrading these vertical curves and stopping sight distance.

See Appendix G for full analysis support the design exceptions and design waivers. See Appendix E for the preliminary plan and profile sheets.



## DESIGN ALTERNATIVES

Several alternatives and sub-alternatives were evaluated during the environmental process to arrive at the preferred alternative. Many sub-alternatives, such as the location of truck and passing lanes, were based on input from local M&O, area landowners, commercial vehicle operators, and highway users.

### Centerline Alignment Alternatives

Four centerline alternatives were evaluated during the environmental process to arrive at the preferred alternative in comparison to the existing alignment. The centerline alignment alternatives evaluated maximum allowable grade and auxiliary lanes.

The centerline alternatives developed are

- **P1.** This alternative meets 70 mph design speed with the primary focus on maximizing geometric improvements.
- **P1\_6%.** This is the same as P1, except it allows for 6% maximum vertical grade instead of a 5%.
- **P2.** This alternative meets 70 mph design standards with a primary focus on optimizing constructability and earthwork considerations.
- **P2\_6%.** This is the same as P2, except it allows for 6% maximum vertical grade instead of a 5%.

The significant differences of these alternatives are described below. For comparison, see Figure 4 and Figure 5 for the alternative alignments and the existing alignment.

#### Alternative P1 and P1\_6%

- Eliminates broken back curves
- Minimizes horizontal curvature
- Highest traffic operations performance
- Minimizes traffic control due to large cut at MP 321 being completely off existing alignment
- 4.8 million cubic yards of excavation
- 375-acre overall footprint

### Alternative P2 and P2\_6%

- Follows existing geometry as closely as practicable
- Maintains broken back curve from MP 321 to MP 323
- Reduced right-of-way (ROW) impacts
- Limits fill over the existing alignment
- 4.2 million cubic yards of excavation
- Increases traffic maintenance challenges due to reconstruction occurring over the existing alignment
- 335-acre overall footprint

### **Maximum Allowable Grade**

Alignment alternatives were evaluated considering a 5% or 6% maximum allowable grade. The design standard for 70 mph in mountainous terrain is 5%, however the Parks Highway has numerous 6% and steeper grades in the general vicinity of the project area, but outside the project improvement limits. As a compromise, a 6% grade was evaluated to reduce project cost and footprint while still generally meeting the needs of vehicular traffic on this Interstate route.

Analysis of the 5% versus 6% determined that there was no substantial change in excavation quantities to warrant the design exception to 6% maximum grade, and the areas where it would have the greatest cost savings were the areas with documented grade related crashes (MP 317 to MP 325).



PARKS HIGHWAY RECONSTRUCTION MP 325 TO MP 305  
 FIGURE 4 ALTERNATIVE ALIGNMENT COMPARISON MP 325-315

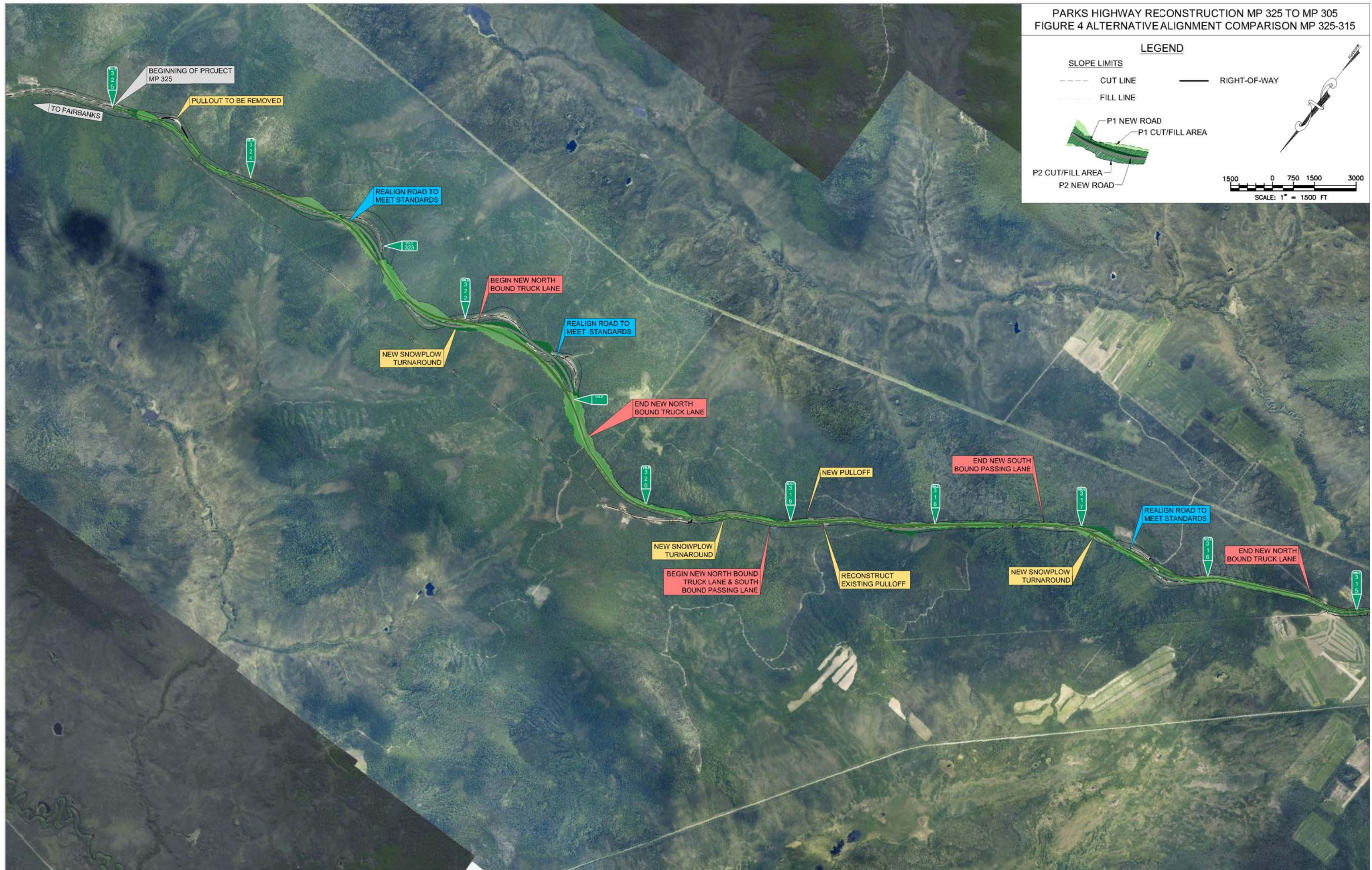



PARKS HIGHWAY RECONSTRUCTION MP 325 TO MP 305  
 FIGURE 5 ALTERNATIVE ALIGNMENT COMPARISON MP 315-305

LEGEND

SLOPE LIMITS

--- CUT LINE

--- FILL LINE

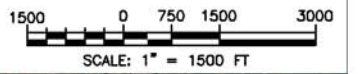
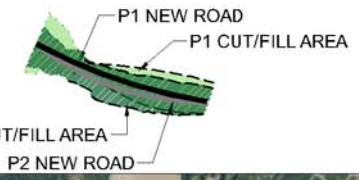



## Auxiliary Lanes

The location of truck climbing and passing lanes were selected based on input from local M&O, area landowners, commercial vehicle operators, highway users, and results from Interactive Highway Safety Design Module (IHSDM) software analysis. Possible auxiliary lane locations were evaluated to enhance traffic operations, by reducing the percent time spent following and increasing the average travel speed.

Maintaining and improving the existing passing and truck lanes was the preliminary approach to selection of auxiliary lane locations, while adding passing opportunities for the southbound direction.

Auxiliary lane locations were established with the following criteria:

### Passing Lanes

- 2 miles long, spaced evenly throughout the project
- Begin or end full passing lanes on tangents and a minimum 200 ft from driveways

### Truck Lanes

- Warranted when truck speed decreases by 15 mph
- Begin or end full truck lanes on tangents and a minimum 200 ft from driveways

Auxiliary lanes are not recommended from MP 305 to MP 309, due to the existing two-lane bridge over the Alaska Railroad, numerous driveways, the narrow corridor between the Tanana River and the Alaska Railroad, and slower speeds near the city of Nenana. “Passing lane in 1 mile” signs are recommended for drivers heading northbound in this section.

A southbound passing lane is not recommended between MP 319.5 and MP 325 due to the significant earthwork already occurring in this area. The additional lane causes the footprint to disproportionately grow because of the large cut slopes. However, adding a northbound passing lane in this area would improve traffic operations by decreasing the total delay time and percent time spent following and increase the average travel speed. The construction of this two-mile-long southbound passing lane is estimated at \$8M. A northbound lane is required for trucks in this area.

After receiving public comments, auxiliary lanes were re-positioned to better align with public concerns while meeting the established criteria. The 4-lane passing location considered from MP 313.5 to MP 315.5, was revised to address public concern about four lanes of traffic through residential and agricultural areas. Table 1 shows the proposed passing and truck lane locations.

Table 1: Auxiliary Lane Locations

Location	Northbound	Southbound	Function	Justification
MP 321 – 322	X		Truck	5% grade for 5,600 ft
MP 317.5 – 319.5		X	Passing	First reasonable location for passing southbound
MP 315 – 319.5	X		Truck	4% and 5% grades with short flat sections insufficient to recover speed
MP 313 – 314.5		X	Passing and Truck	Acceleration lane from rest stop and 5% grade for 2,300 ft
MP 309.25 – 311.25	X	X	Passing	Last reasonable location for passing before entering the city of Nenana

For the truck lane warrant analysis see Appendix C traffic analysis.

### **Agricultural Area (MP 313 to MP 316)**

During the February 2018 public meeting, concern was raised about moving agricultural equipment between properties from MP 313 to MP 316, due to the four lanes encouraging speeding through the area, increasing the difficulty for residents to turn onto the highway. To address the public concerns, the design team considered options such as widening the shoulders, adding a frontage road, and adjusting the passing lanes.

Widening the shoulders from 8-ft to 10-ft for slow moving equipment was considered. However, safety analysis indicated that widening the shoulder did not demonstrate any improved predicted safety performance. Also, a 10-ft shoulder could be considered a travel lane and create additional hazards.

A frontage road was also considered to provide more direct access between parcels, while controlling access to the Parks Highway. This alternative was dismissed due to requiring relocation of the overhead utility line poles and areas of the frontage road requiring 10 to 20-ft of fill. The initial frontage road alignment requires an additional 11 acres of ROW through residential area. The rough order of magnitude estimate, to construct the 1-mile long frontage road, is approximately \$1.2M, relocation of the utility is not included.

Adjustment of the passing lanes was implemented due to concerns about crossing four lanes of traffic. Relocating a northbound passing lane and shortening the southbound passing lane reduces the concern of crossing multiple lanes of traffic and provides additional area for agricultural traffic to operate.

### **Turnouts**

Turnout locations were selected to improve sight distance by locating on tangents, minimize crossing traffic by adding turnouts on both sides of the highway, and increase the capacity of the

turnout. The existing turnouts are located near MP 319, MP 309, and MP 306. Local M&O provided the project team with the initial locations for upgrading or relocating.

The turnout at MP 319 provides a chain up area for trucks and viewing of Minto Flats. Optimizing this turnout location includes increasing the length. The turnout will be reconstructed to connect to the highway and an additional turnout will be constructed opposite the existing turnout to provide northbound traffic a chain up area without having to cross the highway.

The existing turnout at MP 309 will be reconstructed to be attached to the highway. This turnout will also provide M&O a turnaround area following the southbound auxiliary lane between MP 311 and MP 309.

The existing MP 306 turnout will be removed and replaced with a new turnout near MP 307. The existing turnout is located on a curve with poor sight distance making for hazardous entry and exit. The new turnout will be constructed on a tangent to improve sight distance. The new location will be lengthened to provide storage area for vehicles waiting to access Boat Landing Road.

Additional M&O snowplow turnarounds will be constructed at the end of auxiliary lanes. A turnout will be provided for each auxiliary lane and will be located on tangents outside of the auxiliary lane area.

### **Little Goldstream Creek Bridge**

Four alternative bridge options were considered. The proposed bridge will be wider and longer than the existing bridge to accommodate 8-ft shoulders for roadway consistency, improved bicycle and pedestrian provisions, and a larger hydraulic opening. The four bridge alternatives include:

- Two Lane Bridge
- Three Lane bridge
- Four Lane Bridge
- Two Symmetrical two-lane bridges

Each bridge alternative was analyzed with precast decked bulb-tee girders and steel plate girders. It is recommended to construct the bridge using precast decked bulb-tee girders, due to the greater cost and maintenance required for the steel plate girders.

The reconstructed Little Goldstream Creek Bridge will have two lanes, to coincide with the auxiliary lane locations as discussed above and minimize the potential for encroachment into an environmentally sensitive area.

## **PREFERRED DESIGN ALTERNATIVE**

The design team held a design charrette November 2-3, 2017 to discuss and evaluate the design alternatives. The meeting included Department staff from Preconstruction, Construction, and M&O, Toghottthele Corporation, Lynden Transport, and Michael Baker International. After two days of discussing the alternatives and evaluating design ideas to improve the alternatives, the team concluded that Alternative P1 was the preferred alignment based on lower predicted crash rates, increased average travel speed, and improved operations by commercial vehicles being able to maintain speed and ease of navigating a straighter road through the mountainous terrain of the project.

An Alternatives Analysis was also completed on the alignment alternatives. The analysis evaluated the centerline alternatives based on nine criteria:

1. Traffic Operations
2. Safety
3. Utility Impacts
4. Environmental Impacts
5. Freight Operations
6. ROW Impacts
7. Constructability and Traffic Control
8. Construction Cost
9. Maintenance Considerations

Each criterion was given a weight to reflect its relative importance to the project. While each alternative was given a score, from -2 (much worse) to +2 (much better), to capture how it compared to the existing alignment. The evaluation shows that P1 is the more favorable alternative based on the criteria.

See *Parks Highway Milepost 305-325 Reconstruction Alternatives Analysis Methodology Memorandum* dated December 27, 2017 for detailed analysis in Appendix H. Table 2 shows the scoring matrix from the Alternatives Memo.



Table 2: Alternative Evaluation Matrix

Criteria & Weight	Traffic Operations	Safety	Utility Impacts	Environmental Impacts	Freight Operations	ROW Impacts	Constructability & Traffic Control	Construction Cost	Maintenance	Total Score
	20	20	5	5	5	5	10	10	20	
Alternative										
No Build	0	0	0	0	0	0	0	0	0	0
P1	2	2	-1	0	2	-2	-2	-2	2	38
P1_6%	1.5	2	-1	0	1.5	-2	-2	-1.5	2	34
P2	1.5	-1	-1	0	1.5	-1	-1	-1	2	14
P2_6%	1	-1	-1	0	1	-1	-1	-1	2	8

Alternative P1 consists of reducing horizontal curvature, improving passing opportunities, and replacing the existing functionally obsolete Little Goldstream Creek Bridge No. 678 with a new bridge. This alternative was selected over Alternative 2 for the following reasons:

- Fewer traffic impacts to the existing highway during construction
- More desirable traffic operations
- Improved sight distance
- Lower predicted crash rate

The preferred alignment will provide three auxiliary lanes in each direction. These auxiliary lanes will increase traffic operations by reducing percent time spend following and increasing the average travel speed. The auxiliary lane locations are as follows in Table 3:

Table 3: Auxiliary Lane Locations

Location	Northbound	Southbound	Function	Justification
MP 321 – 322	X		Truck	5% grade for 5,600 ft
MP 317.5 – 319.5		X	Passing	First reasonable location for passing southbound
MP 315 – 319.5	X		Truck	4% and 5% grades with short flat sections insufficient to recover speed
MP 313 – 314.5		X	Passing and Truck	Acceleration lane from rest stop and 5% grade for 2,300 ft
MP 309.25 – 311.25	X	X	Passing	Last reasonable location for passing before entering the city of Nenana

The preferred alternative will require the relocation of underground and overhead utility crossings as described in the UTILITY RELOCATION AND COORDINATION section.

The preferred bridge design is a precast bulb-tee girder two-lane bridge with 8-ft shoulders which will provide safe accommodation for traffic, bicycles and pedestrians, a larger hydraulic opening, and increased resistance to scour.

### **3R ANALYSIS**

A 3R analysis is not applicable to this reconstruction project.

### **TRAFFIC ANALYSIS**

The Parks Highway is classified as a rural Interstate highway through the project area. The 2016 Average Annual Daily Traffic (AADT) is 1,800 vehicles per day (vpd). The annual growth rate of traffic is estimated at 1.25% per year with the 2040 design year AADT projected to be 2,430 vpd. See the design criteria and design designation in Appendix A for additional information.

The project corridor currently has no southbound passing lanes. This project will add southbound passing lane locations which are expected to improve traffic operations and reduce overall delays.

A draft traffic analysis was completed in April of 2018. The analysis used FHWA's IHSDM software to model traffic operations and consistency of operating speeds.

The IHSDM predicts traffic operations will see an overall average travel speed increase of 2.5 mph (or 8 minutes through the project limits), a decrease in percent time spent following of 20%, a decrease in total delay of 1.0 min/veh, and an improvement in level of service.

The project shows a high level of design consistency, meaning the expected operating speeds on curves and tangents are typically within 6 mph of each other.

Further details of the traffic analysis can be found in the *Draft Traffic and Safety Report, Parks Highway 305-325 Reconstruction* dated April 11, 2018 in Appendix H.

## HORIZONTAL/VERTICAL ALIGNMENT

The project contains 33 horizontal curves, of which 17 do not meet current design standards of a minimum radius of 2,040 ft.

Table 4: Deficient Horizontal Curves

<b>Curve Number</b>	<b>Location (MP)</b>	<b>Radius (ft)</b>
1	324.6	1909.86
2	324.3	1909.86
4	323.5	1950.00
5	323.1	1155.00
6	322.8	1145.92
7	322.3	1440.00
8	321.7	1152.00
9	321.4	881.47
10	321.1	825.00
11	320.9	1041.74
18	318.2	1950.00
21	317.0	1450.00
23	316.6	1160.00
24	316.3	825.00
25	315.9	1909.86
26	315.3	1980.00
27	315.1	1909.86

The vertical alignment has seven segments that exceed the maximum allowable grade of 5% and 34 vertical curves that do not meet minimum crest curve K value of 247 or sag curve K value of 181.

Table 5: Deficient Vertical Curves

Segment Number	Location	Curve Type	K Value	Grade In	Grade Out	Deficiency
2	1402+90.94	Sag	106.41	-3.15%	4.02%	K Value
3	1413+16.88	Crest	93.34	4.02%	-4.53%	K Value
4	1424+99.60	Sag	72.82	-4.53%	-0.48%	K Value
5	1435+04.44	Sag	139.44	-0.48%	3.49%	K Value
6	1445+60.94	Crest	122.29	3.49%	-3.48%	K Value
7	1473+90.45	Sag	133	-3.48%	0.53%	K Value
8	1503+11.97	Crest	165.26	0.53%	-4.21%	K Value
9	1521+90.24	Sag	121.67	-4.21%	1.76%	K Value
10	1568+85.75	Crest	91.1	1.76%	-6.95%	K Value /Grade
11	1589+23.28	Sag	66.77	-6.95%	-3.80%	K Value /Grade
12	1598+67.45	Crest	237.87	-3.80%	-6.97%	K Value /Grade
13	1615+76.08	Sag	78.48	-6.97%	-0.70%	K Value /Grade
14	1627+12.39	Sag	131.83	-0.70%	3.26%	K Value
16	1671+11.55	Sag	49	0.52%	1.29%	K Value
17	1697+60.50	Crest	244.81	1.29%	-0.77%	K Value
18	1709+09.63	Crest	174.02	-0.77%	-4.20%	K Value
19	1716+79.66	Sag	94.94	-4.20%	-0.50%	K Value
20	1728+02.29	Crest	176.19	-0.50%	-5.29%	K Value /Grade
21	1747+80.03	Sag	79.26	-5.29%	-0.60%	K Value /Grade
22	1753+03.51	Sag	89.03	-0.60%	4.71%	K Value
23	1764+65.67	Crest	115.48	4.71%	-5.06%	K Value /Grade
24	1785+89.03	Sag	133.64	-5.06%	-0.28%	K Value /Grade
25	1804+01.22	Crest	158.16	-0.28%	-5.06%	K Value /Grade
26	1820+38.92	Sag	151.1	-5.06%	-1.50%	K Value /Grade
27	1826+15.26	Crest	158.94	-1.50%	-4.79%	K Value
31	1943+29.94	Sag	151.85	-0.01%	4.47%	K Value
32	1952+03.36	Crest	219.59	4.47%	1.22%	K Value
34	2014+96.14	Crest	208.61	5.11%	-5.14%	K Value /Grade
35	2042+63.55	Sag	146.02	-5.14%	-1.10%	K Value /Grade
41	2120+24.38	Crest	231.7	0.70%	-2.30%	K Value
42	2130+02.57	Sag	170.02	-2.30%	0.42%	K Value
43	2142+90.46	Crest	177.29	0.42%	-2.05%	K Value
44	2167+76.79	Sag	176.84	-2.05%	2.16%	K Value
45	2182+58.75	Crest	212.12	2.16%	-2.75%	K Value

Improving the horizontal and vertical alignment requires the Parks Highway to be realigned between MP 320 and MP 323 and near MP 317. This realignment will improve the safety of the corridor, traffic operations, and sight distances. Within this realignment, horizontal and vertical curves will meet or exceed current design standards, improve passing opportunities, and construct new turnouts. From MP 305 to MP 315, the project will reconstruct the Parks Highway

primarily following the existing horizontal and vertical alignment to improve passing opportunities and construct new turnoffs. The project will increase the curve radius of 17 horizontal curves and 31 vertical curves, improve the grade of five segments, and raise the finished grade across Little Goldstream Creek to improve the hydraulic capacity. The three vertical curves between MP 324 and MP 325 will be maintained to reduce traffic impacts, reduce cost, and improve constructability at the beginning of project.

See Appendix E for the preliminary plan and profile sheets.

### TYPICAL SECTIONS

The Parks Highway will consist of two 12-ft lanes with 8-ft shoulders. The passing and truck lanes will consist of an additional 12-ft lane and maintain 8-ft shoulders. See Figure 6 and Figure 7 for fill and cut typical sections, respectively.

Figure 6: Parks Highway Typical Section (Fill)

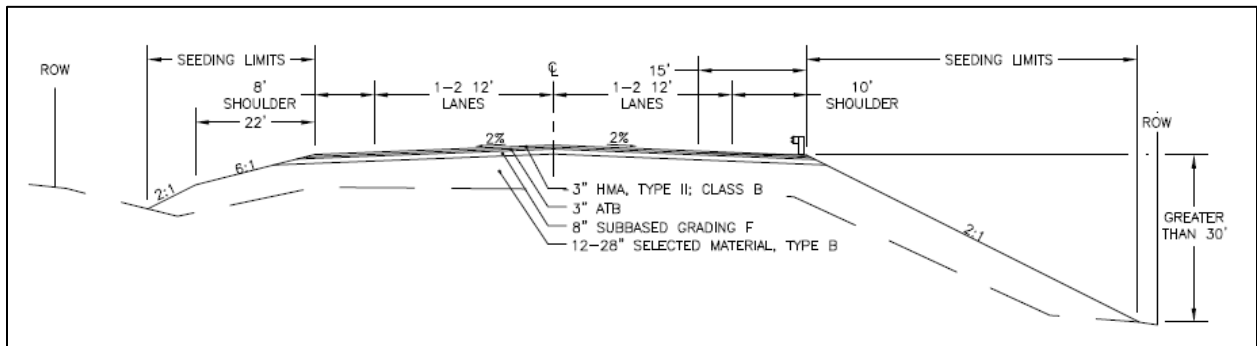
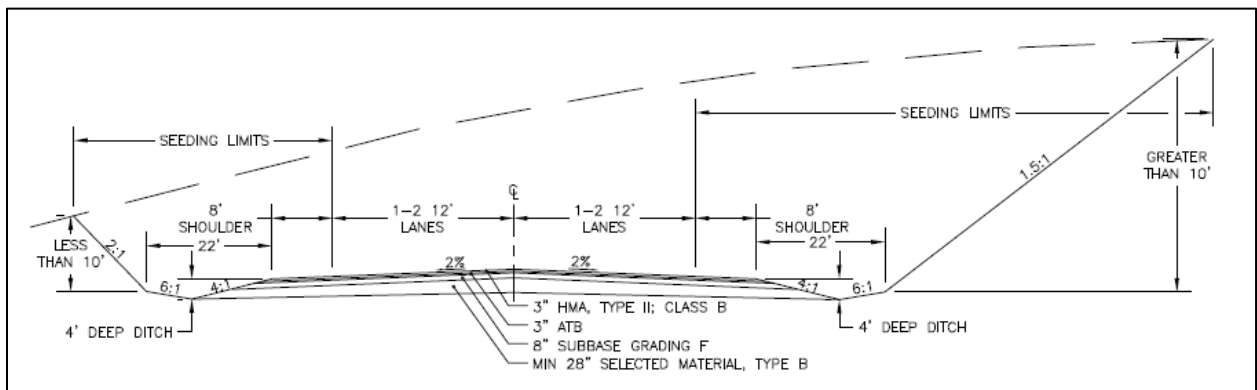
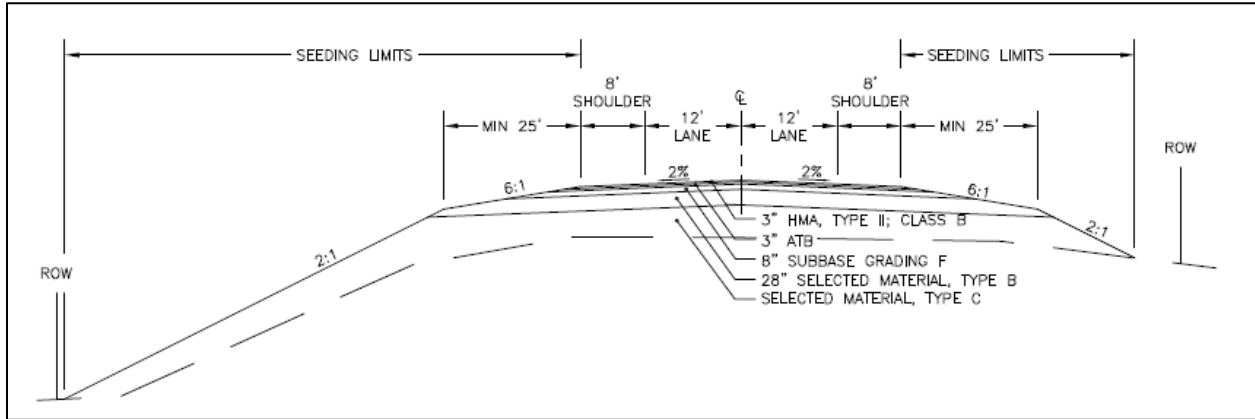

Figure 7: Parks Highway Typical Section (Cut)



The realignment between MP 321 and MP 323 will generate excess material which will be placed along the alignment near the realignment. The excess material will minimize the need for guardrail by flattening and widening the clear zone. The embankment typical section in the excess areas will maintain the typical section along the alignment with a variable-width foreslopes at a 6:1 grade (up to 200-ft wide) preceding a 2:1 grade to daylight within the ROW. See Figure 8 for the Parks Highway typical section with excess material placement.

Figure 8: Parks Highway Typical Section (Excess Material Placement)



## PAVEMENT DESIGN

The selected pavement design was evaluated using the Alaska Flexible Pavement Manual and associated software (ADOT&PF, 2004). The design life of the pavement is 15 years in accordance with General Policy – 6 and General Policy – 10. General Policy – 10 dictates a 2-inch (in) minimum asphalt concrete thickness. General Policy – 6 dictates a minimum of one layer of binder course, asphalt-treated base course, or other stabilized base.

The selected pavement design consists of 3-in of hot mix asphalt, Type II; Class “B”, 3-in of asphalt treated based, and 8-in of Subbase Grading F. The pavement design will be underlain by a minimum of 28-in of Select Material, Type B for realigned sections of the project and by a minimum of 12-in of Select Material, Type B for reconstructed sections. The pavement design was analyzed using the mechanistic design method and is consistent with recent Parks Highway projects in the area. See Appendix D for the pavement design and engineering calculations.

## PRELIMINARY BRIDGE LAYOUT

This project will replace the existing Little Goldstream Bridge No. 678. The proposed bridge is wider and longer than the existing bridge to accommodate 8-ft shoulders for roadway consistency, improved bicycle and pedestrian provisions, and a larger hydraulic opening.

The proposed bridge is 124-ft long and consists of single span precast decked bulb-tee girders with spill through abutments supported on 4’-0” wide by 4’-0” high continuous foundations. Abutment foundations are anticipated to be founded on a single row of 24-in diameter by ½-in thick driven pipe piles.

The minimum surface elevation of the proposed bridge is 399.6-ft, to provide a minimum of 3-ft free board below the girders, as required by the ADOT&PF Highway Drainage Manual (2006). For the 124-ft simple span, a girder depth of 4’-6” is anticipated.

See Appendix F for preliminary bridge plans.

## RIGHT-OF-WAY REQUIREMENTS

An estimated 81 acres from 33 parcels would be needed for this project. Table 6 identifies locations of ROW acquisition which are shown in Figure 9 and Figure 10. During final design, the alignment will be evaluated to minimize ROW impacts.

The realignment from MP 320 to MP 324 will require 19 parcels be acquired from Toghoththele Corporation (with subsurface permanent interest being obtained from Doyon Native Corporation). These lands would be acquired by fee acquisition to the Department. The realignment of MP 320 to MP 324 is necessary to meet the design criteria for the project.

Realignment between MP 316 and MP 317 will require approximately 14 parcels being acquired from the Alaska Department of Natural Resources (ADNR). The ADNR lands are within the Tanana State Forest and would be acquired by perpetual easement acquisition to the Department. This section of the realignment is necessary to remove a sharp horizontal curve, which is susceptible to crashes.

Table 6: ROW Acquisition Locations

<b>Begin Station</b>	<b>End Station</b>	<b>Offset</b>	<b>ROW (Acres)</b>
1464+00	1480+50	LT	5.4
1484+20	1507+46	RT	12.1
1511+70	1521+36	RT	3.2
1509+71	1539+79	LT	9.7
1543+46	1613+59	RT	40.6
1594+77	1630+98	LT	4.1
1814+43	1827+22	RT	2.6
1830+35	1842+85	LT	3.7



PARKS HIGHWAY RECONSTRUCTION MP 305 TO MP 325  
FIGURE 9 MP 320 TO MP 324 RIGHT OF WAY ACQUISITIONS

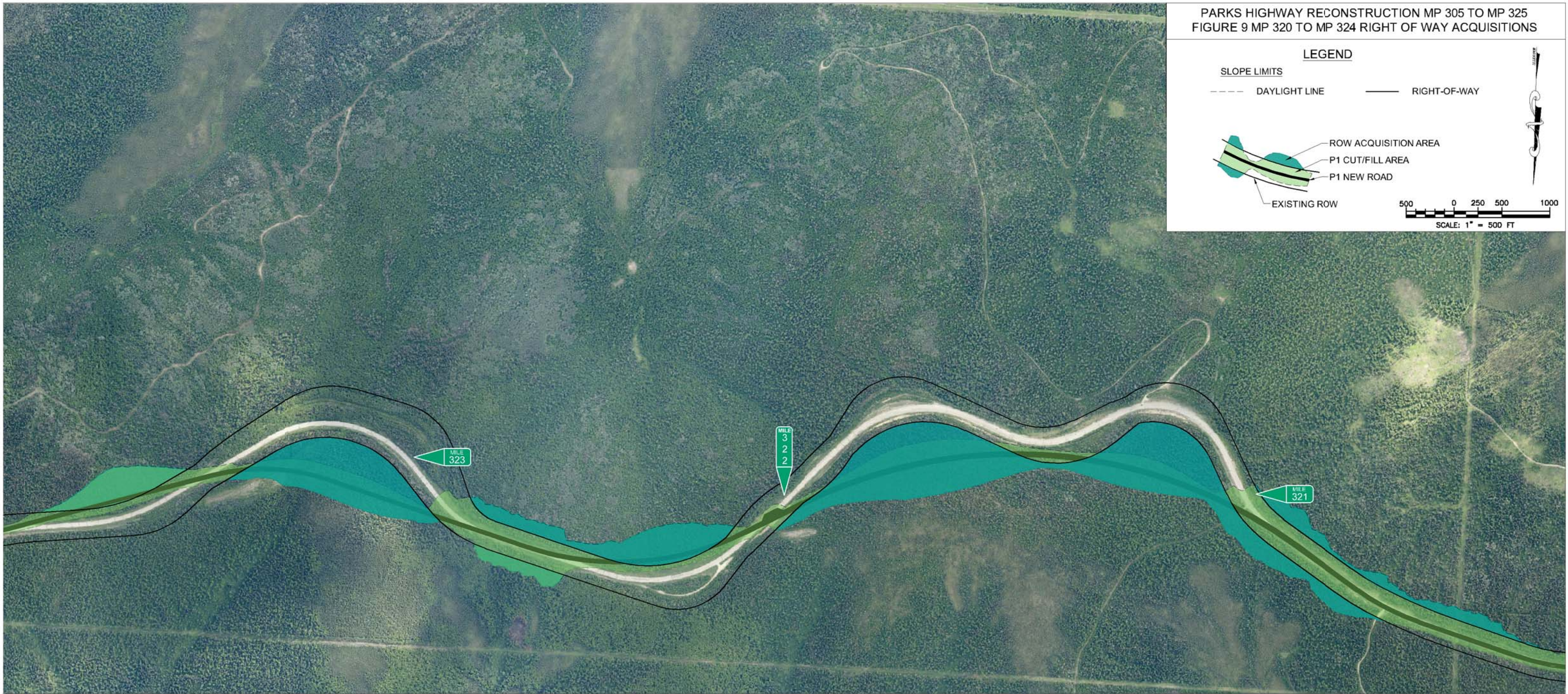
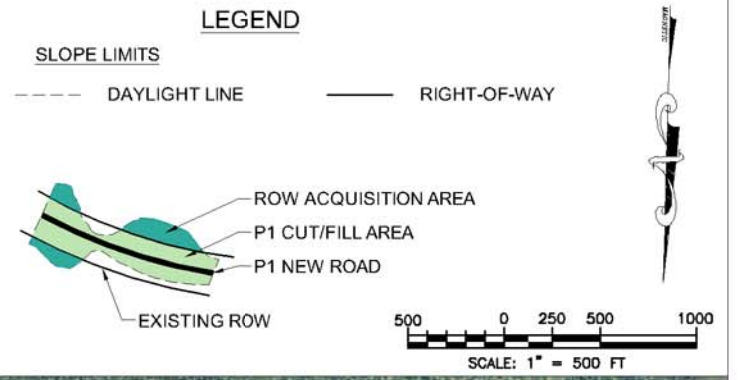



PARKS HIGHWAY RECONSTRUCTION MP 305 TO MP 325  
FIGURE 10 MP 316 TO MP 317 RIGHT OF WAY ACQUISITIONS

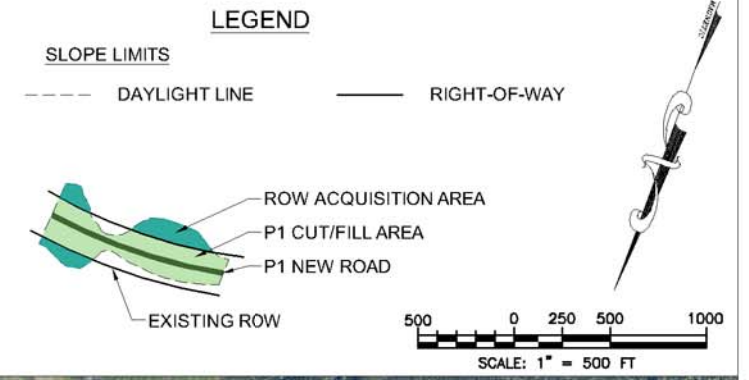



## **MAINTENANCE CONSIDERATIONS**

The Department's M&O staff have been involved in the design of the project and identified maintenance concerns along the corridor. The concerns include:

- Limited sight distance at MP 325 and MP 307
- Continued guardrail replacement at MP 321 due to deficient curves and high crash frequency
- High crash frequency at MP 317 curve due to substandard geometry and icing problems
- Annual asphalt patching at MP 316
- Ditch sedimentation problems at MP 311
- Poor sight distance for the pullout near MP 306, which is heavily utilized by trucks
- Insufficient drainage provisions from approximately MP 316 to MP 319
- Vagrancy and poor sight lines for the pullout (old road alignment) just south of Skinny's Hill (MP 322)
- Sink hole immediately south of Little Goldstream Creek

M&O also identified several areas for project enhancements, including:

- Additional snow plow turnarounds for passing and climbing lane sections
- Additional pullouts for trucks to chain up (~MP 318.5), and widen existing southbound pullout to fit two trucks side by side
- Flattening slopes at Skinny's Hill (MP 322)
- Using flat (6:1 or less) backslopes so they can be mowed using a skid mounted mower (Riley Creek Bridge Replacement typical section desired)
- Clear ROW to ROW wherever feasible and allow firewood pickup during construction
- Consider high friction pavement for shady areas (north facing)

The improved and additional passing lanes will increase the total lane miles within the project area from 44.0 miles to 50.3 miles. Snow plow turnarounds are proposed at the end of each passing lane to aid snow removal.

Proposed project elements expected to result in reduced maintenance efforts include:

- Improving horizontal curvature to current design standards
- Reducing the length of guardrail within the project limits through improved clear zone slopes and realignment
- Upgrading drainage, including new culverts and ditches
- Incorporating geotechnical recommendations to reduce future road settlement
- Using 6:1 fore and backslopes within the clear recovery area for mow-ability

## **MATERIAL SOURCES**

Project material requirements include paving aggregates, aggregate base course, Selected Material Type B, Selected Material Type C, and riprap. It is anticipated sufficient Selected Material Type C will be generated from excavated material.

There are four material sites located within the project limits; M.S. 37-1-045-2 Pit No. 28, Doyon Pit, and two Undeveloped Source pits, located between MP 307 and MP 308. These material sources are anticipated to contain the required types of material, however may not provide the required quantity.

It is anticipated aggregates will need to be imported for the project. The Rex Pit (MP 277, M.S. 37-2-069-2) is an active material source located approximately 28 miles from the end of the project. It contains a large quantity of aggregate material with consistent quality sufficient for crushed products. A slightly closer site, but with questionable material quantity, is the Clear Sky Pit (MP 279, M.S. 37-2-067-2). Long hauls will be required to transport the material to the project site, however these are the closest available pits with suitable material.

## **UTILITY RELOCATION AND COORDINATION**

Permitted utilities within the project belong to Golden Valley Electric Association (GVEA), General Communication Incorporated (GCI), Alaska Communications Systems (ACS), and ACS of the Northland. The project contains overhead distribution and transmission lines, communication lines, and fiber optic cables. The overhead GVEA electrical line route also contains fiber optic lines for much of the corridor.

There are 60 permitted utility lines within the project limits with 33 permitted crossings. Of the permitted crossings, there are 17 overhead crossing locations containing 21 utility crossings. Assuming a minimum height of 20-ft is maintained, proposed improvements will require the adjustment of four overhead crossing locations. In addition, buried lines in areas with culvert replacements or road widening may require underground relocations of buried fiber optic and cable lines.

The proposed Alaska State Gas Line is anticipated to follow the Parks Highway between MP 308 and MP 305. In this area, the gas line will cross the Parks Highway twice. Coordination will be required to maintain adequate cover for the gas line.

## **ACCESS CONTROL FEATURES**

No access control features are included. The Parks Highway is not an access-controlled facility at this location. Existing approach geometry will be modified as necessary to maintain access to the reconstructed facility.

## **PEDESTRIAN/BICYCLE (ADA) PROVISIONS**

Existing 8-ft shoulders accommodate bicycle and pedestrians. The Little Goldstream Bridge replacement will include 8-ft shoulders (current shoulders are non-existent).

## **SAFETY IMPROVEMENTS**

This project brings nearly all the roadway characteristics of the existing highway up to current design standards. These improvements result in improved safety which is the primary focus of this reconstruction. This project involves the following safety improvements:

- Realign roadway to upgrade substandard horizontal and vertical geometry
- Reconfigure turnouts for driver rest and chain up area
- Improve sight distance at intersections
- Clear vegetation to ROW where feasible to increase sight distance
- Increase clear zone area to current standards
- Add 8-ft shoulders to Little Goldstream Creek Bridge No. 678

A draft safety analysis was completed in April of 2018. The analysis used FHWA's IHSDM software to model crash rates to quantify safety improvements of the geometric changes. The IHSDM predicts that crash rates will decrease where site specific geometric improvements are made.

Further details of the safety analysis can be found in the *Draft Traffic and Safety Report, Parks Highway 305-325 Reconstruction* dated April 11, 2018 in Appendix H.

## **INTELLIGENT TRANSPORTATION SYSTEM FEATURES**

Not applicable. There are no intelligent transportation system features within the project limits.

## **DRAINAGE**

Drainage from the project area flows into the following 5<sup>th</sup> level watersheds: West Goldstream Creek, West Goldstream Creek – Two Mile Lakes, and Swanneck Crossing – Tanana River, with stream crossings at Little Goldstream Creek and five unnamed streams, see Table 6. Ditches will be maintained or enhanced to provide roadway drainage. Existing cross culverts will be replaced or added as needed and the Little Goldstream Creek Bridge No. 678 will be replaced. The total number of culverts along the proposed project corridor is expected to be 80.

Table 7: Parks Highway Project Corridor National Hydrography Dataset Streams

Stream Name	Location (MP)
Unnamed Stream	309
Unnamed Stream	309.25
Unnamed Stream	310
Unnamed Stream	310.75
Unnamed Stream	311.25
Little Goldstream Creek	314.8

A Preliminary Hydraulic and Hydrologic analysis was completed in May of 2016. The analysis concluded that to facilitate improved drainage along the project corridor, several 24-in culverts will be replaced with 36-in culverts. The purpose of the larger diameter culverts will be to better accommodate sedimentation, ice buildup, and debris accumulation in the culvert barrel and thus provide better drainage conveyance. Re-grading drainage ditches adjacent to culverts will improve flow at the culvert inlets. Sediment basins may be required to intercept fine sediments upstream of the culvert inlets.

Two new 48-in corrugated metal pipe (CMP) culverts are proposed at MP 310.4 and MP 312.1 to improve drainage.

Hydraulic analysis of an existing 3.2-ft high (H) by 4.7-ft wide (W) CMP culvert at MP 310.6 shows that design criteria are met. However, a detailed analysis is recommended to evaluate if the existing culvert should be replaced by a larger circular culvert, two circular culverts, a box culvert, or a pipe arch culvert.

An existing 48-in CMP culvert at MP 312.6 meets all design criteria and road overtopping is not a concern.

Further details can be found in the *Preliminary Hydraulic & Hydrologic Report, Parks Highway 305-325 Reconstruction* dated May 18, 2016 in Appendix H.

Table 7 provides the average total precipitation, total snowfall, and snow depth for the project area. Data is taken from the Western Regional Climate Center website using the National Oceanic and Atmospheric Administration (NOAA) Cooperative Stations station data (NOAA 2018).

Table 8: Average Total Precipitation, Average Total Snowfall, and Average Snow Depth

Nearest Town	Average Total Precipitation (in)	Average Total Snowfall (in)	Average Snow Depth (in)
Nenana, AK	10.73	45.0	8.0
<b>Source:</b> NOAA 2018. "Period of Record Monthly Climate Summary for Nenana Muni, Alaska." Western Regional Climatic Center. <a href="https://wrcc.dri.edu/cgi-bin/cliMAIN.pl?ak6309">https://wrcc.dri.edu/cgi-bin/cliMAIN.pl?ak6309</a> (Accessed July 11, 2018).			

## SOIL CONDITIONS

The project corridor extends through the Tanana floodplain and the Yukon-Tanana uplands. In the floodplain, soils are generally comprised of silt (1-ft to 30-ft below ground surface) over sand and gravel. In the uplands, wind-blown silt (loess) lays over metamorphic bedrock.

The Department’s Geotechnical Asset Management Program for Unstable Slopes identified four locations along the project corridor as “poor”. “Poor” conditions indicate unstable soil and embankment slopes likely due to thaw settlement or frost heave distress.

Potential geohazards identified along the project corridor include surface fault rupture, lateral spreading and liquefaction, thawing of frozen soils, frost heaving, and slope stability.

The average monthly air temperature, freezing degree days, and thawing degree days for Nenana Municipal Airport are provided in Table 8. Historical Climate Data was taken from the Western Regional Climate Control website using NOAA Cooperative Stations data (NOAA 2018). Table 8 provides the mean annual air temperature, freezing index, and thawing index. The mean annual air temperature is 26.7 °F, and the freezing index and thawing index are 5,208 °F-days and 3,265 °F-days, respectively.

Table 9: Mean Monthly Air Temperature and Freezing/Thawing Degree Days

Month	Mean Temperature (°F)	Freezing Degree Days (°F-days)	Thawing Degree Days (°F-days)
Jan	-5.9	1,175.4	0.0
Feb	-2.1	987.5	0.0
Mar	11.5	635.7	0.0
Apr	29.9	115.4	52.1
May	47.7	0.0	485.2
Jun	58.3	0.0	789.8
Jul	61.0	0.0	898.9
Aug	54.8	0.0	706.6
Sep	42.9	0.0	326.7
Oct	22.3	307.7	5.8
Nov	1.8	904.9	0.0
Dec	-2.9	1,081.3	0.0

**Source:** NOAA 2018. “Period of Record Monthly Climate Summary for Nenana Muni, Alaska.” Western Regional Climatic Center. <https://wrcc.dri.edu/cgi-bin/cliMAIN.pl?ak6309> (Accessed July 11, 2018).

A detailed geotechnical investigation will be conducted to better characterize soils in the project area.

## **EROSION AND SEDIMENT CONTROL**

Estimated acreages of ground disturbing activities are 600 acres, including the material sites, however with project phasing this is not anticipated to be the amount of ground disturbance occurring at one time. This will require a Storm Water Pollution Prevention Plan (SWPPP). Discharge of stormwater from the site will be regulated in accordance with a National Pollutant Discharge Elimination System permit. This will require the preparation of an Erosion and Sediment Control Plan during final design, in accordance with Section 1120.7 of the PCM, and the development of a SWPPP by the Contractor prior to construction. The project is primarily in uplands, with minor wetlands near Little Goldstream Creek. Vegetation in the area varies and includes spruce, birch, aspen, willows, and shrubs.

Permanent and temporary measures will be required at the project site to control erosion, sedimentation, and discharge of pollutants which may include temporary seeding, erosion control mats, watering and/or chemical stabilization for dust control, velocity control Best Management Practices, and perimeter controls. Perimeter controls may be installed at the toe of slope to prevent excessive sedimentation to down-slope vegetation and water bodies. The preferred perimeter protection method in the project area will be vegetated buffer, with positive protection devices such as straw wattles at the edge of water bodies.

Little Goldstream Creek is a low gradient meandering stream with potential for bank migration. Riprap or other bank stabilization methods are recommended for protection against bank erosion.

All disturbed ground will be vegetated or covered with low erodible soil (e.g., Selected Material Type A, riprap, or ditch lining) for permanent stabilization.

## ENVIRONMENTAL COMMITMENTS

The Environmental commitments and mitigation measures are summarized in Table 9.

Table 10: Environmental Commitments

<b>Environmental Concern</b>	<b>Commitment/Mitigation Measure</b>
Prehistoric Site located within APE	Department will install temporary fencing under the terms of the recommendation by NLURA. No equipment or personnel associated with this project will be allowed beyond the fence's perimeter. The installation of the fencing will be monitored by the Northern Region PQI. Periodic site visits that will include written and photographic documentation to the project files will be done by the Northern Region PQI during construction, and the fencing will be removed at the conclusion of the work under the PQI's supervision
Bird Nesting Window (May 1 – July 15)	The Department will adhere to the USFWS guidance on avoiding vegetation clearing during the bird nesting window as supplied by the USFWS.
Bald and/or Golden Eagle Nests	Eagle nests are not currently known to exist within the vicinity (within a half mile) of the project, though there is a known eagle nest 2 miles from the project area. If an eagle nest is identified within a half mile of the project area, the Department will contact the USFWS for further assistance.
Contaminated Sites	There is a known contaminated site at MP 321, the Department will contact ADEC Spill Prevention and Response if contamination is encountered from this site.
Invasive Species	Implemented measures to minimize and control the spread of invasive species will be defined in the Erosion and Sedimentation Control Plan (ESCP). Standard contract specifications such as seeding disturbed areas with certified weed-free native, perennial grass seed mixtures will help minimize erosion as well as establishment of invasive species.
Pollutant Discharge Elimination	The conditions stipulated in the 2016 Alaska Pollutant Discharge Elimination System Construction General Permit will be adhered to during project construction.

See Appendix B for the environmental document.



## **WORK ZONE TRAFFIC CONTROL**

This project is not considered significant for traffic control per the Department's Policy and Procedure 05.05.015. The Parks Highway is an Interstate, but the project is not in a Transportation Management Area; the AADT is less than 30,000 vpd, and work is not expected to fully close the highway for more than one hour at a time.

Construction of the proposed Little Goldstream Creek Bridge No. 678 will utilize half-width staged construction or a road diversion allowing traffic to be maintained on the existing during construction.

Some portions of the work may require intermittent lane closures and/or reduction of traveled way widths. The Contractor will develop traffic control plans for the work that will be submitted to the Department for approval prior to implementation.

## **VALUE ENGINEERING**

Per Department policy, this project, with a total estimated value greater than \$40M, must be considered for a value engineering (VE) analysis. A VE analysis is still being considered for this project.

## **CONSTRUCTION PHASING**

The estimated construction cost of the total project is \$154,200,000, due to the large cost of the project it is important to break the project into smaller construction projects to obtain more manageable construction budgets.

In May 2018, the team discussed potential phasing options to divide the project into manageable projects in respect to budget, balancing mass haul, and constructability. Four phases have been identified to obtain manageable projects. See Figure 11 for construction phase break down based on mass haul.

## Figure 11: Mass Haul vs Construction Cost

Construction of MP 325 – 314 was determined as being the most important part of this project due to crash data and M&O observations. Reconstructing this segment replaces the Little Goldstream Bridge No. 678 and the realignment increases safety and minimizes M&O burden by reducing horizontal and vertical curvature.

Note that construction costs shown are rough order of magnitude, detailed cost estimates will be developed as the project detailed design is completed and geotechnical investigation is complete.

### **COST ESTIMATE**

The Construction cost estimate is based on the preferred alignment. An itemized construction cost estimate was developed and can be made available to internal Department staff. Per Department Policy & Procedure 10.02.040, detailed construction cost estimates may not be made available to the public or other interested parties.



The estimated costs for this project are as follows:

Design	\$7,000,000
Utilities	\$2,000,000
Right of Way	\$1,000,000
Construction (Includes 10.0% Engineering)	\$154,200,000
<b>Total Cost of Project</b>	<b>\$164,200,000</b>



**Appendix A**  
**DESIGN CRITERIA**  
**AND**  
**DESIGN DESIGNATION**

<b>Project Name:</b> Parks Highway 305 - 325 Reconstruction	
<input checked="" type="checkbox"/> New Construction/Reconstruction <input type="checkbox"/> Reconstruction (3R) <input type="checkbox"/> Other:	
<b>Project Number:</b> Z606570000/0A45028	<input checked="" type="checkbox"/> NHS <input type="checkbox"/> Non NHS
<b>Functional Classification:</b>	Principal Arterial (Interstate)
<b>Design Year:</b>	2040
<b>Design Year ADT:</b>	3000
<b>DHV:</b>	14.5%
<b>Percent Trucks:</b>	17.0%
<b>Pavement Design Year:</b>	2040
<b>Terrain:</b>	Rolling to Mountainous
<b>Design Speed:</b>	70
<b>Width of Traveled Way:</b>	24
<b>Width of Shoulders:</b>	<b>Outside:</b> 8 <b>Inside:</b> 0
<b>Cross Slope:</b>	2%
<b>Superelevation Rate:</b>	$e_{max}=6\%$
<b>Minimum Radius of Curvature:</b>	2,040 Ft
<b>Minimum K-Value for Vertical Curve:</b>	<b>Sag:</b> 181 <b>Crest:</b> 247
<b>Maximum Allowable Grade:</b>	5%
<b>Minimum Allowable Grade:</b>	0.0%
<b>Stopping Sight Distance:</b>	730-ft
<b>Lateral Offset to Obstruction:</b>	1.5-ft
<b>Vertical Clearance:</b>	16.5-ft
<b>Bridge Width:</b>	40-ft
<b>Bridge Structural Capacity:</b>	HL-93
<b>Passing Sight Distance:</b>	1200
<b>Surface Treatment:</b>	<b>T/W:</b> Asphalt Concrete <b>Shoulders:</b> Asphalt Concrete
<b>Side Slope Ratios:</b>	<b>Foreslopes:</b> 4H:1V <b>Backslopes:</b> 4H:1V
<b>Degree of Access Control:</b>	Driveway/entrance regulations
<b>Median Treatment:</b>	N/A
<b>Illumination:</b>	N/A
<b>Curb Usage and Type:</b>	N/A
<b>Bicycle Provisions:</b>	Shoulders
<b>Pedestrian Provisions:</b>	Shoulders
<b>Misc. Criteria:</b>	Clear Zone: 30-ft

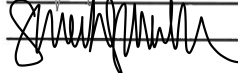
**Proposed - Designer/Consultant:**  RaeAnne Hebnes/Michael Baker International  
**Accepted - Engineering Manager:**   
**Approved - Preconstruction Engineer:** 



**Date:** 9-Dec-19  
**Date:** 12/16/19  
**Date:** 1/29/2020

Shaded criteria are the *FWHA 13 controlling criteria*. For NHS routes only, these criteria must meet the minimums established in the Green Book (AASHTO A Policy on Geometric Design of Highways and Streets). For all other routes, these criteria must meet the minimums established in the *Alaska Highway Preconstruction Manual*. Otherwise a Design Exception must be approved.

*Design Criterion marked with a " # " do not meet minimums and have a Design Exception(s) and/or Design Waiver(s) approved. See Appendix \_\_\_ for Design Exception/Design Waiver approval(s) and approved design criteria values.*



<b>Project Name:</b>		Parks Highway 305 - 325 Reconstruction (Design Exception Area - MP 323.5-325)	
<input checked="" type="checkbox"/> New Construction/Reconstruction		<input type="checkbox"/> Reconstruction (3R) <input type="checkbox"/> Other:	
<b>Project Number:</b>		Z606570000/0A45028	<input checked="" type="checkbox"/> NHS <input type="checkbox"/> Non NHS
<b>Functional Classification:</b>		Principal Arterial (Interstate)	
<b>Design Year:</b>	2040	<b>Present ADT:</b>	1800
<b>Design Year ADT:</b>	3000	<b>Mid Design Period ADT:</b>	2140
<b>DHV:</b>	14.5%	<b>Directional Split:</b>	35/65
<b>Percent Trucks:</b>	17.0%	<b>Equivalent Axle Loading:</b>	1,530,697
<b>Pavement Design Year:</b>	2040	<b>Design Vehicle:</b>	WB-40
<b>Terrain:</b>	Mountainous	<b>Number of Roadways:</b>	1
<b>Design Speed:</b>	70		
<b>Width of Traveled Way:</b>	24		
<b>Width of Shoulders:</b>	<b>Outside:</b>	8	<b>Inside:</b> 0
<b>Cross Slope:</b>	2%		
<b>Superelevation Rate:</b>	e <sub>max</sub> =6%		
<b>Minimum Radius of Curvature:</b>	2,040 Ft		
<b>Minimum K-Value for Vertical Curve:</b>	<b>Sag:</b>	111#	<b>Crest:</b> 98#
<b>Maximum Allowable Grade:</b>	5%		
<b>Minimum Allowable Grade:</b>	0.0%		
<b>Stopping Sight Distance:</b>	730-ft		
<b>Lateral Offset to Obstruction:</b>	1.5-ft		
<b>Vertical Clearance:</b>	16.5-ft		
<b>Bridge Width:</b>	40-ft		
<b>Bridge Structural Capacity:</b>	HL-93		
<b>Passing Sight Distance:</b>	1200		
<b>Surface Treatment:</b>	<b>T/W:</b>	Asphalt Concrete	<b>Shoulders:</b> Asphalt Concrete
<b>Side Slope Ratios:</b>	<b>Foreslopes:</b>	4H:1V	<b>Backslopes:</b> 4H:1V
<b>Degree of Access Control:</b>	Driveway/entrance regulations		
<b>Median Treatment:</b>	N/A		
<b>Illumination:</b>	N/A		
<b>Curb Usage and Type:</b>	N/A		
<b>Bicycle Provisions:</b>	Shoulders		
<b>Pedestrian Provisions:</b>	Shoulders		
<b>Misc. Criteria:</b>	Clear Zone: 30-ft		

**Proposed - Designer/Consultant:**  RaeAnne Hebnes/Michael Baker International  
**Accepted - Engineering Manager:**   
**Approved - Preconstruction Engineer:** 

**Date:** 9-Dec-19  
**Date:** 12/16/19  
**Date:** 1/29/2020

Shaded criteria are the *FWHA 13 controlling criteria*. For NHS routes only, these criteria must meet the minimums established in the Green Book (*AASHTO A Policy on Geometric Design of Highways and Streets*). For all other routes, these criteria must meet the minimums established in the *Alaska Highway Preconstruction Manual*. Otherwise a Design Exception must be approved.

**Design Criterion marked with a "# " do not meet minimums and have a Design Exception(s) and/or Design Waiver(s) approved. See Appendix G for Design Exception/Design Waiver approval(s) and approved design criteria values.**



# MEMORANDUM

# State of Alaska

Department of Transportation & Public Facilities

**TO:** Sarah E. Schacher, P.E.,  
Preconstruction Engineer  
Northern Region

**DATE:** November 28, 2017

**FILE NO:** I:\Traffic Data\Design\2017\ParksHwy MP 305-325\_Z606570000

**TELEPHONE NO:** 451-5150

*JMC*  
**FROM:** Judy Chapman  
Planning Chief  
Northern Region

**SUBJECT:** Parks Hwy MP 305-325 Reconstruction  
Z606570000/0A45028

Please approve the attached design designation by signing the endorsement below which enables your staff to proceed.

Any questions should be directed to Scott Vockeroth at 451-2251.

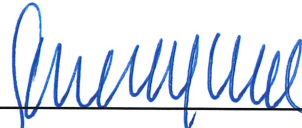
  
\_\_\_\_\_  
Sarah E. Schacher, P.E., Preconstruction Engineer

12/6/2017

Date

cc: Lauren Little, P.E., Engineering Manager, Northern Region

Attachment

Please circulate and return to Traffic Data & Forecasting Manager	
Planning Manager (outside FNSB)	<i>MLC</i>
Planning Chief	<i>JMC</i>
Fairbanks Area Planner (FNSB)	<i>em</i>
Traffic & Safety	
Any changes, additions, or questions, Please write on this sheet	

---

**DESIGN DESIGNATION**  
**Northern Region Planning**  
**Traffic Data & Forecasting**

---

**ROUTE NAME:** Parks Hwy  
**STATE ROUTE NO:** 170000  
**CDS MILEAGE:** 269.513-289.111  
**FUNCTIONAL CLASS:** Interstate  
**URBAN/RURAL:** Rural

	YEAR	AADT	%	
<b>AADT</b>	2016	1800		
	2030	2140		
	2040	2430		
<b>DHV</b>	2030		14.50	310
	2040			360
<b>D</b>				35-65
<b>T</b>			<b>17.00</b>	<b>Total</b>
			1.5	Class 4
			6.50	Class 5
			1.20	Class 6
			0.50	Class 8
			2.40	Class 9
			1.40	Class 10
		3.50	Class 13	
<b>ESAL'S (Design Lane)</b>	To Be Provided by Design			

# MEMORANDUM

**State of Alaska**  
**Department of Transportation & Public Facilities**  
**Northern Region Design and Engineering Services**

**TO:** Judy Chapman  
Planning Chief  
Northern Region

**DATE:** November 27, 2017

**FILE NO:** H:\Projects\Parks\_Hwy\60657\_Parks\_305\_325\Design\PS&E\4DS  
R\60657\_DD\_Request.docx

**THRU:** Sarah E. Schacher, P.E.  
Preconstruction Engineer  
Northern Region

**PHONE NO:** (907) 451-5371

**FAX NO:** (907) 451-5487

**FROM:** Lauren Little, P.E. LL  
Engineering Manager  
Northern Region

**SUBJECT:** Parks Hwy MP 305-325  
Reconstruction  
Z606570000/0A45028  
**Design Designation Request**

Please provide a Design Designation for the subject project.

- Present AADT
- Design Year AADT (2040)
- Mid-Design Period AADT (2030)
- Design Hourly Volume
- Directional Split
- Percent Trucks
- Design Functional Classification
- Intersection Turning Movement Counts at:
- Other (*Specify*)

The project is scheduled for construction in FY2020.

Please complete the attached Traffic Data Request Form.

Attachment: as stated

lml







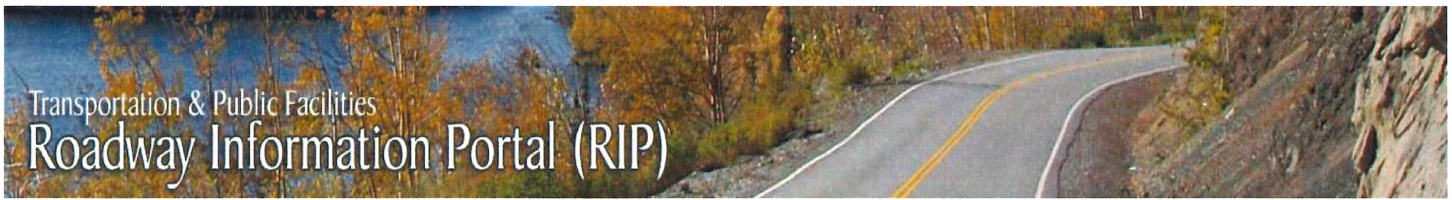























Traffic Date Request Form			TDR Form-1-10/20/03
Alaska Department of Transportation & Public Facilities			
Requested By: Lauren Little		Design Project Number: 0A45028/Z606570000	Date Requested: 12/27/2017
Base Year: 2016 Base Year Total AADT: 1800 AADT Growth Rate Forward (%/yr): 1.25      End Year: 2040 Back Forcast (%/yr):      Begin Year:		Common Route Name: Parks Highway Functional Class: Principal Arterial (Interstate) Urban/Rural Historic M.P. Interval: 305 to 325	CDS Route Name: 170000 CDS M.P. Interval: 269.513 - 289.111
Truck Category	Load Factor (ESALs per Truck)	% of Total AADT in Truck Category	<b>Lane Configuration Sketch:</b> (Designer: Provide sketch of lane layout. Number Each lane and show directions.)  
2-axle			
3-axle	See		
4-axle	attached		
5-axle			
≥6-axle			
Percent of Base Year Total AADT for Each Numbered Lane in Configuration Sketch:			Comments:
Lane #	1	% 35	
Lane #	2	% 65	
Lane #		%	
Lane #		%	
Lane #		%	
Data Provided By: Scott Vockerath		Providers Signature: 	Date Provided: 11/28/17

Figure 6-1. Traffic Data Request (TDR) Form



**Report** Route Log  
**CDS Route** PARKS HIGHWAY (170000)  
**From Milepoint** 265  
**To Milepoint** 310  
**Filter** FacilityType INTERCHANGE RAMP;NON-INVENTORY;WYE;SECONDARY FERRY ACCESS;ROUNDBOUT;PRIMARY FERRY ACCESS;NON-INTERCHANGE RAMP;MAINLINE;CONNECTOR

Milepoint	Attribute	Side	Feature CDS	Description	Viewer
265	Functional Class	-	-	INTERSTATE (Start at Milepoint 0)	
265	Speed	-	-	65 (Start at Milepoint 214.6865)	
265	Traffic Link	-	-	AL003191 (Start at Milepoint 254.2385)	
266.4764	Traffic Station	-	-	10400035	
266.4799	Traffic Station	L	-	17000301	
267.3225	Speed	-	-	65 -> 55	
268.0677	Intersection	R	174564	AIRPORT ROAD	
268.0677	Traffic Link	-	-	AL003191 -> AL200245	
268.1885	Speed	-	-	55 -> 45	
268.3456	Intersection	B	174562	10TH STREET	
268.7275	Intersection	R	174515	A STREET	
268.7487	Intersection	B	174502	SIXTH STREET	
269.3608	Traffic Station	-	-	31089000	
269.376	Bridge Midpoint	U	-	TANANA RIVER AT NENANA (0202)	
269.6132	Bridge Midpoint	U	-	NORTH SLOUGH TANANA RIVER (0201)	

Milepoint	Attribute	Side	Feature CDS	Description	Viewer
269.6926	Speed	-	-	45 -> 55	 
270.2027	Speed	-	-	55 -> 65	 
272.1007	 Intersection	L	174504	NOOUTLET ROAD	 
272.3756	Traffic Link	-	-	AL200245 -> AL001079	 
272.4782	 Bridge Midpoint	U	-	MONDERSOA OVERHEAD (1980)	 
272.8318	Traffic Station	-	-	31021000	 
272.9581	 Intersection	L	174505	MONDEROSA DRIVE	 
278.8454	 Bridge Midpoint	U	-	LITTLE GOLDSTREAM CREEK (0678)	 
301.1929	 Bridge Midpoint	U	-	BONANZA CREEK (7117)	 
305.4321	Traffic Link	-	-	AL001079 -> AL001080	 
305.4321	 Intersection	L	174800	OLD NENANA HIGHWAY	 



## Computations and Historical Data

**Project:** Parks Hwy Reconstruction Z606570000/0A45028

### Historical AADTs

Link	Start MP	Start Feature	End MP	End Feature	Year					
					1980	1981	1982	1983	1984	1985
1	268.07	Airport Rd *Nenana*	272.38	Monderosa Bridge						
2	272.38	Monderosa Bridge	305.43	Old Nenana Hwy						

Link	Year														
	1986	1987	1988	1989	1990	1991	1992	1993	1994	1995	1996	1997	1998	1999	2000
1		1270				1796	1501	1771	1798	1373	1703	1897	2095	1956	1755
2	1438	1127	1128	1349	1392	1639	1444	1329	1686	1781	1648	1771	1936	1870	1603

Link	Year														
	2001	2002	2003	2004	2005	2006	2007	2008	2009	2010	2011	2012	2013	2014	2015
1	1866	2088	2168	2033		2041	1967	1804			1833	1896	1834	1631	1849
2	1746	1960	2146	1766	1803		1873	1723	1636	1795	1748	1788	1836	1703	1796

Link	Year	
	2016	2017
1	1898	
2	1877	

**Growth Rate:** 1.25% Growth rate based on historical traffic patterns

<b>Growth Factors:</b>		Year	Factor
		2030	1.190
		2040	1.347

<b>Future AADT</b>	Year	AAADT
	2016	1800
2030	2140	
2040	2430	

**D Factor (30)** 35-65

**K-Factor (30)** 14.50% Obtained from Continuous Count Station on Parks Hwy in Nenana MP 301

**Design Hourly Volume (DHV)** 2030 310  
2040 360

### Class Data

Station ID	Station Description	MP	Year	Percent by Class								Total Truck %
				4	5	6	8	9	10	13		
17000301	Parks Hwy South Of Nenana	266.529	2016	1.50	6.50	1.20	0.50	2.40	1.40	3.50	17.00	
	Load Factor			1.00	0.50	0.85	1.20	1.55	2.24	2.24		
	Number of Axles			2/3	2	3	4	5	6	7+		

**Appendix B**  
**ENVIRONMENTAL DOCUMENT**

State of Alaska  
Department of Transportation & Public Facilities



**CATEGORICAL EXCLUSION DOCUMENTATION FORM**  
(NEPA Assignment Program Projects)

The environmental review, consultation, and other actions required by the applicable Federal environmental laws for this project are being, or have been carried out by the DOT&PF pursuant to 23 U.S.C 327 and a Memorandum of Understanding dated November 3, 2017, and executed by FHWA and DOT&PF.

**I. Project Information:**

**A.** Project Name: Parks Highway MP 305-325 Reconstruction

**B.** Federal Project Number: 0A45028

**C.** State Project Number: Z606570000

**D.** Primary/Ancillary Project Connections: None

**E.** CE Designation: 23 CFR 771.117(d)(13)

**F.** List of Attachments:

Appendix A – Figures

Appendix B – Class of Action

Appendix C – Government to Government

Appendix D – Wetlands

Appendix E – Public Involvement Documentation

Appendix F – Section 106

Appendix G – Noise

Appendix H – Section 4(f)

Appendix I – Location Hydraulic Study

Appendix J – Agency Scoping

**G.** Project Scope (*Use STIP Project Description*)

Reconstruct the Parks Highway including drainage improvements, passing lanes, and replacement of Little Goldstream Creek Bridge No. 678.

**H.** Project Purpose and Need:

The Alaska Department of Transportation and Public Facilities (DOT&PF) is proposing to reconstruct the Parks Highway from MP 305 (Tanana River Bridge No. 202) to MP 325, including drainage improvements, realignment of curves for safety, passing lanes, and replacement of Little Goldstream Creek Bridge No. 678.

One of the primary purposes of this project is to improve the safety of the transportation corridor. Using the most current 10 years of available crash data (2007-2016), this segment of the Parks Highway in Northern Region has the second highest rate of injury and fatal crashes, second only to MP 164-185 which also has a current project in design.

This project will also serve to upgrade this Interstate corridor to eliminate seasonal load restrictions, and enhance commercial and recreational function. New and improved turnouts will also provide commercial and recreational traffic a safe location to rest or chain up prior to negotiating the mountainous terrain between Nenana and Fairbanks.



The Parks Highway is the primary overland route between Alaska’s two largest cities, Anchorage and Fairbanks, and also serves as a tourist corridor for the Denali National Park and Preserve and other scenic interests. Both local and commercial truck utilize this route to deliver goods and services between these two cities and their outliers year round. The highway experiences increasing traffic volumes throughout the summer months due to time-sensitive seasonal activities like construction and tourism.

Currently the highway is subject to seasonal load restrictions resulting in higher costs to commercial operators. Pavement data for the project area indicates that the pavement is nearing the end of its useful life.

The Park Highway in the project area was upgraded in 1967 from the original Nenana-Fairbanks highway (1950’s era construction). It was rehabilitated, paved, and truck climbing lanes added in 1985. Since then there have been two Highway Safety Improvement (HSIP) funded projects linked to the deficient curves in the MP 321 area for enhanced signage. Beyond the HSIP project and occasional M&O projects such as crack sealing the project corridor has remained largely unimproved since the 1985 construction, increasing the risk to travelers of this corridor due to safety deficiencies. In addition to the deficient curves in the MP 321 area, the existing paved surface is in poor condition and there are insufficient cross culverts starting around MP 319 that lead to failed pavement areas and sediment in the ditches. The Little Goldstream Creek Bridge No. 678 is also structurally deficient and functionally obsolete.

**I. Project Description:**

The Parks Highway MP 305 to 325 Reconstruction Project is located between the Tanana River Bridge at Nenana (MP 305) and the Fairbanks North Star Borough boundary (MP 325). The total project length is approximately 19 miles. See Figures 1-5.

This project includes the following work items:

- Road realignments to eliminate sub-standard horizontal and vertical geometry;
- Additional passing and climbing lanes and improvements to existing passing and climbing lanes to meet current standards;
- New and relocated turnouts;
- Pavement section improvements;
- Improved sight distance at intersections;
- New and improved ditching;
- Culvert replacements and installation of new culverts;
- Replacement of the structurally deficient Little Goldstream Creek Bridge (No. 678);
- Signing, striping, tree and brush clearing for visibility, and installation of rumble strips.

On September 21, 2018 DOT&PF confirmed the project to be a categorical exclusion under 23 CFR 771.117. A copy of the Class of Action and correspondence is located in Appendix B.

**II. Environmental Consequences**

- For each “yes,” summarize the activity evaluated and the magnitude of the impact.
- For any consequence category with an asterisk (\*), additional information must be attached such as an alternatives analysis, agency coordination or consultation, avoidance measures, public notices, or mitigation statement.
- Include direct and indirect impacts in each analysis.

**A. Right-of-Way Impacts**

N/A    YES    NO

1. Additional right-of-way required. If no, skip to 2.

a. Permanent easements required.

Estimated number of parcels: 14

- | <b>A. <u>Right-of-Way Impacts</u></b>  | <u>N/A</u> | <u>YES</u>                          | <u>NO</u>                           |
|--|------------|-------------------------------------|-------------------------------------|
| <b>b.</b> Full or partial property acquisition required.<br>Estimated number of full parcels: <u>0</u><br>Estimated number of partial parcels: <u>19</u>   |            | <input checked="" type="checkbox"/> | <input type="checkbox"/>            |
| <b>c.</b> Property transfer from state or federal agency required. <i>If yes, list agency in No. 4 below.</i>  |            | <input checked="" type="checkbox"/> | <input type="checkbox"/>            |
| <b>d.</b> Business or residential relocations required. If yes, insert the number of relocations below, summarize the findings of the conceptual stage relocation study in No. 4 below and attach the conceptual stage relocation study. If no, skip to 2.<br>i. Number of business relocations: <u>0</u><br>ii. Number of residential relocations: <u>0</u>   |            | <input type="checkbox"/>            | <input checked="" type="checkbox"/> |
| <b>e.</b> Last-resort housing required.  |            |                                     |                                     |
| <b>2.</b> Will the project or activity have disproportionately high and adverse human health or environmental effects on minority populations and low-income populations as defined in <a href="#">E.O. 12898</a> (FHWA Order 6640.23A, June 2012)?  |            | <input type="checkbox"/>            | <input checked="" type="checkbox"/> |
| <b>3.</b> The project will involve use of ANILCA land that requires an <a href="#">ANILCA Title XI</a> approval.   |            | <input type="checkbox"/>            | <input checked="" type="checkbox"/> |
| <b>4.</b> Summarize the right-of-way impacts, if any:<br><br>An estimated 81 acres from 33 parcels would be needed for this project, with 14 being acquired from the Alaska Department of Natural Resources (ADNR) and 19 from the Toghothele Corporation (with subsurface permanent interest being obtained from Doyon Native Corporation). The ADNR lands would be acquired by perpetual easement acquisition to the DOT&PF; and lands from the Toghothele Corporation would be acquired by fee acquisition to the DOT&PF. |            |                                     |                                     |

- | <b>B. <u>Social and Cultural Impacts</u></b>  | <u>YES</u>                          | <u>NO</u>                           |
|---|-------------------------------------|-------------------------------------|
| <b>1.</b> The project will affect neighborhoods or community cohesion.  | <input type="checkbox"/>            | <input checked="" type="checkbox"/> |
| <b>2.</b> The project will affect travel patterns and accessibility (e.g. vehicular, commuter, bicycle, or pedestrian).                                   | <input checked="" type="checkbox"/> | <input type="checkbox"/>            |
| <b>3.</b> The project will affect school boundaries, recreation areas, churches, businesses, police and fire protection, etc.                             | <input type="checkbox"/>            | <input checked="" type="checkbox"/> |
| <b>4.</b> The project will affect the elderly, handicapped, nondrivers, transit-dependent, minority and ethnic groups, or the economically disadvantaged. | <input type="checkbox"/>            | <input checked="" type="checkbox"/> |
| <b>5.</b> There are unresolved project issues or concerns of a federally-recognized Indian Tribe [as defined in <a href="#">36 CFR 800.16(m)</a> ].       | <input type="checkbox"/>            | <input checked="" type="checkbox"/> |
| <b>6.</b> Summarize the social and cultural impacts, if any:  |                                     |                                     |

On April 20, 2018 an EPA Environmental Justice Report was generated and revealed that, of an approximated population of 396 within one mile of the existing centerline of the project area, 37% and 35% percent of the population are minority and low income, respectively. However, the project will not disproportionately adversely affect minorities or low income populations as accessibility to and use of the Parks Highway will be made safer for all users.

No adverse social impacts to neighborhood or community cohesion are anticipated. The project would positively affect travel patterns and accessibility for Parks Highway users by providing a highway with an improved alignment that is safer and more convenient to travel, including improved sight distances at residential driveways that open onto the highway within the project area. Project improvements would not alter the Parks Highway in a

way that would create adverse human health or environmental effects as defined in Executive Order 12898. Access to residential properties and through-traffic will be maintained throughout construction.

**C. Economic Impacts**

YES   NO

1. The project will have adverse economic impacts on the regional and/or local economy, such as effects on development, tax revenues and public expenditures, employment opportunities, accessibility, and retail sales.
2. The project will adversely affect established businesses or business districts.
3. Summarize the economic impacts, if any:

The Project would not have any impacts related to socioeconomic concerns. Beneficial impacts would occur to the State through reduced trucking costs by eliminating seasonal load restrictions, and reduced maintenance and safety driven costs.

**D. Land Use and Transportation Plans**

N/A   YES   NO

1. Project is consistent with land use plan(s).         
 Identify the land use plan(s) and date: Alaska Department of Natural Resources Yukon Tanana Area Plan (YTAP), adopted January 3, 2014.
2. Project is consistent with transportation plan(s).         
 Identify the transportation plan(s) and date.
  - Draft Alaska Statewide Long-Range Transportation Plan 2036, September 2016.
  - State of Alaska DOT&PF Interior Alaska Transportation Plan (IATP), approved November 2010.
3. Project would induce adverse indirect and cumulative effects on land use or transportation. *If yes, attach analysis.* \*
4. Summarize how the project is consistent or inconsistent with the land use plan(s) and transportation plan(s):

Table 1 detail's the project's consistency with local land use and transportation plans:

Table 1: Land Use and Transportation Plans

Plan	Plan Goal/Policy	Project Consistency
Yukon Tanana Area Plan (YTAP) (January 3, 2014)	<b>Land Use Designations and Management Intent:</b> agricultural; settlement; forestry; mineral, habitat, and public recreation.	The project is consistent with the YTAP because improved safety and mobility of the highway supports the land use designations or management intent and guidelines. ANDR's scoping comment also confirmed that the project is consistent with the YTAP.
DRAFT Alaska Statewide Long-Range Transportation Plan 2036 (September 2016)	<b>Modernization:</b> Make the existing transportation system better and safer through transportation system improvements that support productivity, improve reliability, and reduce safety risks to improve performance of the system. <b>System Preservation:</b> Manage the Alaska Transportation System to meet infrastructure condition performance targets and acceptable levels of service for	The project is consistent with this goal by improving the safety of users by bringing the deficient highway to current geometric and structural standards.  Project is consistent with goal by: improving pavement condition and replacing a structurally deficient bridge.



---

all modes of transportation.

---

**Economic Development:** Promote and support economic development by ensuring safe, efficient, and reliable access to local, national, and international markets for Alaska’s people, goods, and resources, and for freight-related activity critical to the State’s economy.

The project is consistent with this goal by eliminating seasonal load restrictions, and reduced maintenance and safety driven costs.

---

**Safety and Security:** Improve transportation system safety and security.

The project is consistent with this goal by improving the safety and mobility of highway users in the project area through the realignment and reconstruction of the geometrically and structurally deficient facility.

---

**Livability, Community, and the Environment:** Incorporate livability, community, and environmental considerations in planning, delivering, operating, and maintaining the Alaska Transportation System.

The project is consistent with this goal by incorporating community and environmental concerns during the project design process through public and agency scoping.

---

**Economic:** Support the economic vitality of the State, metropolitan and non-metropolitan areas, especially by enabling global competitiveness, productivity, and efficiency. Prioritize projects that support, project or enhance economic development.

The project is consistent with this goal by eliminating seasonal load restrictions, and reduced maintenance and safety driven costs.

---

**Health, Safety and Security:** Improve the overall Interior Regional Transportation System to promote the health, safety and security of residents and visitors and for all motorized and non-motorized users.

The project is consistent with this goal by improving the safety and mobility of highway users in the project area through the realignment and reconstruction of the geometrically and structurally deficient facility.

Interior Alaska  
Transportation Plan (IATP)  
(November 2010)

---

**Preservation:** Emphasize preservation of the existing transportation facilities.

Project is consistent with goal by: bringing a geometrically and structurally deficient facility into compliance with standards through highway realignment and bridge replacement; improving pavement structures to reduce the need for seasonal weight restrictions by extending pavement life; and promoting access management strategies by paving and improving sight distance at intersection.

---

**E. Impacts to Historic Properties**

N/A    YES    NO

Consider the [February 2015 DOT&PF Cultural Resources Confidentiality Guidelines](#) for cultural resource attachments.

1. Does the project involve a road that is included on the “[List of Roads Treated as Eligible](#)” in the Alaska Historic Roads PA? If yes, follow the [Interim Guidance for Addressing Alaska Historic Roads](#).



**E. Impacts to Historic Properties**

N/A   YES   NO

**10.** Summarize any effects to historic properties. *List affected sites (by AHRS number only) and any commitments or mitigative measures. Include any commitments or mitigative measures in Section V.*

Government to Government consultation was confirmed to be completed by the Federal Highway Administration on December 11, 2017, with no concerns in regards to potential impacts of the proposed project.

The affected sites are as follows:

- *FAI-01736* – Site is exempt from section 106 review under the Exemption Regarding Historic Preservation Review Process for Effects to the Interstate Highway System (ACHP 2005) and the Program Comment on Common Post-1945 Concrete and Steel Bridges (ACHP 2012). No determination of effect is required for impacts to this site.
- *FAI-02398* – DOT&PF will install temporary fencing under the terms of the recommendation by NLURA for this site. Provided stand-off fencing is installed, a no historic properties adversely affected finding is appropriate for this site. See the Environmental Commitments and Mitigation Measure for details.
- *FAI-02439-02444* – Throughout the implementation of the Alaska Historic Roads Programmatic Agreement Interim Guidance (Roads PA), DOT&PF has understood that the Roads PA applied to all segments of road in Program funded projects. The project is funded by the Program; therefore, these roads and others similarly situated are covered under the Roads PA and its Interim Guidance. Interim guidance on the Roads PA provides that abandoned road segments are exempt from review until the Roads PA is completed and a methodology for evaluation is agreed on by the signatories. As such, DOT&PF finds the road segments within the project area exempt from review.

**F. Wetland Impacts**

YES   NO

1. Project affects wetlands as defined by the U.S. Army Corps of Engineers (USACE). *If yes, complete the remainder of this section and document public and agency coordination required per [E.O. 11990](#), Protection of Wetlands. If no, skip to Section G.*
2. Are the wetlands delineated in accordance with the “[Regional Supplement to the Corps of Engineers Wetland Delineation Manual: Alaska Region \(Version 2.0\) Sept. 2007](#)”?
3. Estimated area of wetland involvement (acres): <0.25
4. Estimated fill quantities (cubic yards): 60
5. Estimated dredge quantities (cubic yards): N/A
6. Is a USACE authorization anticipated?      
*If yes, identify type:*  
NWP    Individual    General Permit    Other
7. Wetlands Finding *Attach the following supporting documentation as appropriate:*  
 *Avoidance and Minimization Checklist, and Mitigation Statement*  
 *Wetlands Delineation.*  
 *Jurisdictional Determination.*  
 *Copies of public and resource agency letters received in response to the request for comments.*
  - a. Are there practicable alternatives to the proposed construction in wetlands?      
*If yes, the project cannot be approved as proposed.*



**F. Wetland Impacts**

YES   NO

- b. Does the project include all practicable measures to minimize harm to wetlands? *If no, the project cannot be approved as proposed.*
- c. Only practicable alternative: Based on the evaluation of avoidance and minimization alternatives, there are no practicable alternatives that would avoid the project's impacts on wetlands. The project includes all practicable measures to minimize harm to the affected wetlands as a result of construction. *If no, the project cannot be approved as proposed.*
- 8. Summarize the wetlands impacts and mitigation, if any. *Include any commitments or mitigative measures in [Section V](#).*

Impacts to wetlands and waters of the U.S. (WOUS) are anticipated to occur at Little Goldstream Creek, where the Little Goldstream Creek Bridge will be replaced. Impacts will involve the removal and placement of fill, including bridge piers and temporary structures as required, within the wetland and WOUS area in order to facilitate the bridge replacement. Impacts are not anticipated to exceed 0.012 acres (<1/10<sup>th</sup> acre, reporting is not required) with 60 cubic yards of fill (temporary and permanent quantities are to be determined), and a NWP 3 Maintenance is anticipated.

**G. Water Body Involvement**

N/A   YES   NO

- 1. Does the project affect the following:
  - a. A water body.
  - b. A navigable water body as defined by USCG, (i.e. Section 9)?    \*
  - c. Waters of the U.S. as defined by the USACE, Section 404?    \*
  - d. Navigable Waters of the U.S. as defined by the USACE (Section 10)?    \*
  - e. Fish passage across a stream frequented by salmon or other fish (i.e. [Title 16.05.841](#))?
  - f. A resident fish stream ([Title 16.05.841](#))?
  - g. A cataloged anadromous fish stream, river or lake (i.e. [Title 16.05.871](#))?    \*
  - h. A designated Wild and Scenic River or land adjacent to a Wild and Scenic River? *If yes, the Regional Environmental Manager should consult with the NEPA Program Manager to determine applicability of Section 4(f).*
- 2. Proposed water body involvement: 
  - Bridge    Culvert    Embankment Fill    Relocation
  - Diversion    Temporary    Permanent    Other
- 3. Type of stream or river habitat impacted: 
  - Spawning    Rearing    Pool    Riffle    Undercut bank
  - Other
- 4. Amount of fill below (cubic yards):
  - OHW \_\_\_\_\_   MHW \_\_\_\_\_   HTL \_\_\_\_\_

Fill amounts within the water body are to be determined, but are not anticipated to exceed 60 cubic yards.

5. Summarize the water body impacts and mitigation, if any. *Include any commitments or mitigative measures in [Section V](#).*

The Little Goldstream Creek is shallow and meandering with no known interstate commerce. The Alaska Department of Natural Resource (ADEC), Navigable Waters Web Map (accessed June 6, 2018 at [http://dnr.alaska.gov/mlw/nav/map\\_disclaimer.htm](http://dnr.alaska.gov/mlw/nav/map_disclaimer.htm)) did not list the Little Goldstream Creek as a navigable waterbody. An estimated 60 cubic yards of fill will occur within and/or surrounding this waterbody during the Little Goldstream Creek Bridge replacements. The category of fish habitat for this vicinity was not specified by communications with ADF&G.

**H. Fish and Wildlife**

N/A   YES   NO

1. Anadromous and resident fish habitat. *Any activity or project that is conducted below the ordinary high water mark of an anadromous stream, river, or lake requires a Fish Habitat Permit.*
  - a. Database name(s) and date(s) queried: ADF&G Fish Resource Monitor; accessed June 6, 2018.
  - b. Anadromous fish habitat present in project area. \*
  - c. Resident fish habitat present in project area. \*
  - d. Adverse effect on spawning habitat.    \*
  - e. Adverse effect on rearing habitat.    \*
  - f. Adverse effect on migration corridors.    \*
  - g. Adverse effect on subsistence species.    \*
  
2. Essential Fish Habitat (EFH). *EFH includes any anadromous stream used by any of the five species of Pacific salmon for migration, spawning or rearing, as well as other coastal, nearshore and offshore areas as designated by NMFS.*
  - a. Database name(s) and date(s) queried: NOAA Essential Fish Habitat Mapper, accessed June 6, 2018.
  - b. EFH present in project area.
  - c. Project proposes construction in EFH. *If yes, describe EFH impacts in H.6.*
  - d. Project may adversely affect EFH. *If yes, attach EFH Assessment.*    \*
  - e. Project includes conservation recommendations proposed by NMFS. *If NMFS conservation recommendations are not adopted, formal notification must be made to NMFS. Summarize the final conservation measures in H.6 and list in [Section V](#).*
  
3. Wildlife Resources:
  - a. Project is in area of high wildlife/vehicle accidents.
  - b. Project would bisect migration corridors.
  - c. Project would segment habitat.
  
4. [Bald and Golden Eagle Protection Act](#). *If yes to any below, consult with USFWS and attach documentation of consultation.*
  - a. Eagle data source(s) and date(s) : USFWS agency scoping response, received December 30, 2015.
  - b. Project visible from an eagle nesting tree? \*
  - c. Project within 330 feet of an eagle nesting tree? \*

**H. Fish and Wildlife**

N/A   YES   NO

- d. Project within 660 feet of an eagle nesting tree? \*
- e. Will the project require blasting or other activities that produce extreme loud noises within 1/2 a mile from an active nest? \*
- f. Is an [eagle permit](#) required? \*
- 5. Is the project consistent with the [Migratory Bird Treaty Act](#)?
- 6. Summarize fish and wildlife impacts and mitigation, including timing windows, if any. *Include any commitments or mitigative measures in [Section V](#).*

The Alaska Department of Fish and Game (ADF&G), Fish Resource Monitor (accessed June 6, 2018 at <http://www.adfg.alaska.gov/index.cfm?adfg=fishpassage.mapping>) lists that there have been no fish collection efforts on the Little Goldstream Creek. However, per the ADF&G agency scoping response the creek is suspected to be a residential fish stream; and there is a potential that a Fish Habitat Permit may be needed for the bridge replacement work at the creek. The Fish Resource Monitor also did not list the creek as an anadromous stream.

The National Oceanic and Atmospheric Association (NOAA) Essential Fish Habitat Mapper (accessed June 6, 2018 at <https://www.habitat.noaa.gov/protection/efh/efhmapper/index.html>) indicated that there is no essential fish habitat within the project area.

Two migratory bird species of conservation concern (Bald Eagle and Golden Eagle) are expected to occur or may be affected by activities at this location, and are protected under the Migratory Bird Act and the Bald and Golden Eagle Protection Act. No eagle nests were observed within the project area during the 2015 wetland delineation. The USFWS 2015 agency scoping response indicated the presence of an eagle nest about two miles west of MP 310, and that while no nests were identified within the immediate project area it is the Department’s responsibility for preventing disturbance to eagles and their nests. If an eagle nest is discovered within a half-mile of the project area, the USFWS will be contacted. In addition, if raptor or swallow nest colonies are found in material sites, the USFWS will be contacted for further recommendations, although no known nest locations were identified.

The Department intends to adhere to the USFWS guidance on avoiding mechanized vegetation clearing during the recommended bird nesting window for the project area (May 1- July 15).

**I. Threatened and Endangered Species (T&E)**

YES   NO

- 1. Database name(s) and date(s) queried: U.S. Fish and Wildlife Service IPaC Database, accessed June 9, 2018.
- 2. Listed threatened or endangered species present in the project area.
- 3. Threatened or endangered species migrate through the project area.
- 4. Designated critical habitat in the project area.
- 5. Proposed or Candidate species present in project area.
- 6. What is the effect determination for the project? *Select one.*
  - a. Project has no effect on listed or proposed T&E species or designated critical habitat.
  - b. Project is not likely to adversely affect a listed or proposed T&E species or designated critical habitat. *Informal Section 7 consultation is required. Attach consultation documentation, including concurrence from the Federal agency, to this form.* \*

**I. Threatened and Endangered Species (T&E)** YES NO

c. Project is likely to adversely affect a listed or proposed T&E species or designated critical habitat. *If yes, consult the NEPA Program Manager.* \*

7. Summarize the findings of the consultation, conferencing, biological evaluation, or biological assessment and the opinion of the agency with jurisdiction, or state why no coordination was conducted. *Include any commitments or mitigative measures in [Section V](#).*

The USFWS was included in the agency scoping process and did not provide any concerns for resources managed by the USFWS. In addition, the IPaC database, accessed June 9, 2018, revealed that there are no threatened and endangered species expected to occur at this location.

**J. Invasive Species** YES NO

1. Database name(s) and date(s) queried: AKEPIC Data Portal, accessed June 9, 2018.

2. Does the project include all practicable measures to minimize the introduction or spread of invasive species, making the project consistent with [E.O. 13112](#) (Invasive Species)? *If yes, list measures in J.3.*

3. Summarize invasive species impacts and minimization measures, if any. *Include any commitments or mitigative measures in [Section V](#).*

Per the AKEPIC Data Portal, access June 9, 2018, the following non-native species are present in the project area: white sweet clover (*Melilotus albus Medik.*), common dandelion (*Taraxacum officinale F.H. Wigg.*), common plantain (*Plantago major L.*), alsike clover (*Trifolium hybridum L.*), foxtail barley (*Hordeum jubatum L.*), pineappleweed (*Matricaria discoidea DC.*), smooth brome (*Bromus inermis Leys.*), narrowleaf hawksbeard (*Crepis tectorum L.*), yellow sweetclover (*Melilotus officinalis (L.) Lam.*), lambsquarters (*Chenopodium album L.*), prostrate knotweed (*Polygonum aviculare L.*), and common pepperweed (*Lepidium densiflorum Schrad.*).

Implemented measures to minimize and control the spread of invasive species will be defined in the Erosion and Sediment Control Plan (ESCP). Standard contract specifications such as seeding disturbed areas with certified weed-free native, perennial grass seed mixtures will help minimize erosion as well as the establishment of invasive weed species. With the implementation of practicable measure to minimize the introduction or spread of invasive species, the project is expected to result in no substantial non-native species-related impacts.

**K. Contaminated Sites** YES NO

1. Database name(s) and date(s) queried: ADEC Contaminated Sites Mapper, accessed June 9, 2018.

2. There are known or potentially contaminated sites within or adjacent to the existing and/or proposed ROW. *If yes, attach ADEC coordination documentation and summarize below in IV.K.4.* \*

3. There are contaminated sites with 1,500 feet of where excavation dewatering is anticipated? *If yes, attach ADEC coordination correspondence and summarize below in IV.K.4.*





**M. Floodplain Impacts (23 CFR 650, Subpart A)**

YES    NO

1. Project encroaches into the base (100 year) flood plain in fresh or marine waters. Identify floodplain map source and date : FEMA Flood Map Service Center, accessed June 11, 2018.

\*   

*If yes, attach documentation of public involvement conducted per [E.O. 11988](#) and [23 CFR 650.109](#). Consult with the regional or Statewide Hydraulics/Hydrology expert and attach the required location hydraulic study developed per [23 CFR 650.111](#). Answer questions M.1.a through d.*

*If no, skip to M.2.*

- a. Is there a longitudinal encroachment into the 100-year floodplain? \*
- b. Is there significant encroachment as defined by [23 CFR 650.105\(q\)](#)? *If yes, attach a copy of FHWA's finding required by 23 CFR 650.115.* \*
- c. Project encroaches into a regulatory floodway. \*
- d. The proposed action would increase the base flood elevation one-foot or greater. \*
2. Project conforms to local flood hazard requirements.
3. Project is consistent with [E.O. 11988](#) (Floodplain Protection). *If no, the project cannot be approved as proposed.*
4. Summarize floodplain impacts and mitigation, if any. *Include any commitments or mitigative measures in [Section V](#).*

Floodplains within the project area are unmapped, and are comprised of the floodplain within the Little Goldstream Creek and the DOT&PF ROW. Temporary minor impacts are anticipated to occur within the floodplain due to the replacement of the Little Goldstream Creek Bridge; significant encroachments and the support of incompatible floodplain development are not anticipated to occur. A Location Hydraulic Study was completed in October 2018 and is attached (Appendix I).

**N. Noise Impacts (23 CFR 772)**

YES    NO

1. Does the project involve any of the following? *If yes, complete N.2.*       
*If no, a noise analysis is not required. Skip to section O.*
- a. Construction of highway on a new location.
- b. Substantial alteration in vertical or horizontal alignment as defined in [23 CFR 772.5](#).
- c. An increase in the number of through lanes.
- d. Addition of an auxiliary lane (except a turn lane).
- e. Addition or relocation of interchange lanes or ramps added to a quadrant to complete an existing partial interchange.
- f. Restriping existing pavement for the purpose of adding a through-traffic lane or an auxiliary lane.
- g. Addition of a new or substantial alteration of a weigh station, rest stop, ride-share lot or toll plaza.
2. Identify below which category of land uses are adjacent: *A noise analysis is required if any lands in Categories A through E are identified, and the response to N.1 is 'yes'.*

*Category A:* Lands on which serenity and quiet are of extraordinary significance and serve an important public need and where the preservation of those qualities is essential if the area is to continue to serve its intended purpose.

*Category B:* Residential. *This includes undeveloped lands permitted for this category.*

*Category C (exterior):* Active sport areas, amphitheaters, auditoriums, campgrounds, cemeteries, daycare centers, hospitals, libraries, medical facilities, parks, picnic areas, places of worship, playgrounds, public meeting rooms, public or nonprofit institutional structures, radio studios, recording studios, recreation areas, Section 4(f) sites, schools, television studios, trails, and trail crossings. *This includes undeveloped lands permitted for this category.*

*Category D (interior):* Auditoriums, day care centers, hospitals, libraries, medical facilities, places of worship, public meeting rooms, public or nonprofit institutional structures, radio studios, recording studios, schools, and television studios.

*Category E:* Hotels, motels, offices, restaurants/bars, and other developed lands, properties or activities not listed above. *This includes undeveloped lands permitted for this category.*

3. Does the noise analysis identify a noise impact? *If yes, explain in N.4*
4. Summarize the findings of the attached noise analysis and noise abatement worksheet, if applicable:

The proposed action is considered a Type I project according to 23 CFR 772 because it would add an auxiliary lane/passing lanes to the Parks. Existing land uses in the project area include residential, commercial, open space, light industrial, and undeveloped/vacant land uses. A noise analysis was completed in October 2018, and determined that the proposed action would not result in noise impacts at any sensitive receptors in the project area, and noise abatement analysis was not required.

**O. Water Quality Impacts**

N/A    YES    NO

1. Project would involve a public or private drinking water source. *If yes, explain in O.7*
2. Project would result in a discharge of storm water to a Water of the U.S. (per [40 CFR 230.3\(s\)](#))
3. Project would discharge storm water into or affect an ADEC designated Impaired Waterbody. *If any of the Impaired Waterbodies have an approved or established Total Maximum Daily Load, describe project impacts in O.7*
- a. List name(s), location(s), and pollutant(s) causing impairment:  
\_\_\_\_\_
4. Estimate the acreage of ground-disturbing activities that will result from the project?  
600 acres.
5. Is there a Municipal Separate Storm Sewer System (MS4) APDES permit, or will runoff be mixed with discharges from an APDES permitted industrial facility?
- a. If yes, list APDES permit number and type: \_\_\_\_\_
6. Would the project discharge storm water to a water body within a national park or state park; a national or state wildlife refuge?

**O. Water Quality Impacts**

N/A   YES   NO

- 7. Summarize the water quality impacts and mitigation, if any. *Include any commitments or mitigative measures in [Section V](#).*

The ADEC Division of Water, accessed August 21, 2018, does not list the Little Goldstream Creek as an impaired waterbody. Temporary water quality impacts from disturbed soils are anticipated within Little Goldstream Creek during the replacement of the Little Goldstream Creek Bridge. BMPs to minimize impacts to water quality from the bridge replacement and from storm water runoff during project construction will be utilized as stipulated in the 2016 Alaska Pollutant Discharge Elimination System Construction General Permit, and will be defined in the Storm Water Pollution Prevention Plan (SWPPP).

While total project disturbed ground is approximately 600 acres, the area would not be worked simultaneously. Project construction packages are proposed to be staged in 5-10 mile segments and contract provisions would limit the amount of ground that could be disturbed and destabilized at one time.

**P. Construction Impacts**

N/A   YES   NO

- |  |                                     |                                     |
|--|-------------------------------------|-------------------------------------|
| 1. There will be temporary degradation of water quality.   | <input checked="" type="checkbox"/> | <input type="checkbox"/>            |
| 2. There will be a temporary stream diversion.   | <input type="checkbox"/>            | <input checked="" type="checkbox"/> |
| 3. There will be temporary degradation of air quality.   | <input checked="" type="checkbox"/> | <input type="checkbox"/>            |
| 4. There will be temporary delays and detours of traffic.  | <input checked="" type="checkbox"/> | <input type="checkbox"/>            |
| 5. There will be temporary impacts on businesses.  | <input type="checkbox"/>            | <input checked="" type="checkbox"/> |
| 6. There will be temporary noise impacts.  | <input checked="" type="checkbox"/> | <input type="checkbox"/>            |
| 7. There will be other construction impacts (e.g. TCEs/TCPs, utility relocates, staging areas, etc.).  | <input checked="" type="checkbox"/> | <input type="checkbox"/>            |
| 8. Summarize construction impacts and mitigation for each 'yes' above. <i>Include any commitments or mitigative measures in <a href="#">Section V</a>.</i> |                                     |                                     |

Water Quality: Temporary degradation of water quality may result during project construction due to a minor increase of erosion and other sediment entering storm water runoff. Implementing a SWPPP would help alleviate temporary water quality impacts.

Air Quality: Temporary impacts to air quality may result during project construction from increased equipment exhaust and dust upheaval from ground disturbance. Construction impacts to air quality will be mitigated with the use of BMPs including watering, sweeping, and stabilizing construction entrances/exits, and will be defined in the ESCP and SWPPP.

Traffic: Temporary delays in traffic, rerouting of traffic, and rerouting of access to local properties may occur during project construction, and will be minimized to the greatest extent practicable. A Traffic Control Plan would be implemented and the public notified prior to construction.

Noise: A minor and temporary increase in noise levels may result during project construction due to the use of heavy equipment and other general construction activities. However, noise impacts from construction would not result in a substantial increase or permanent change in noise levels in the project areas.



**Q. Section 4(f)/6(f)****YES NO****1. Section 4(f) ([23 CFR 774](#))**

- a. Was detailed Section 4(f) resource identification conducted for this project, other than that required for Section 106 compliance? *If no, attach consultation with the NEPA Program Manager stating further Section 4(f) resource identification was not required.*  \*
- b. Does a Section 4(f) resource exist within the project area; or is the project adjacent to a Section 4(f) resource? *If yes, attach consultation with the NEPA Program Manager to determine applicability of Section 4(f). If no, skip to Q.2.* \*
- c. Does an exception listed in [23 CFR 774.13](#) apply to this project? *If yes, attach consultation with the NEPA Program Manager, and documentation from the official with jurisdiction, if required.* \*
- d. Does the project result in the “use” of a Section 4(f) property? “Use” includes a permanent incorporation of land, adverse temporary occupancy, or constructive use. *If no, attach consultation with the NEPA Program Manager and skip to Q.2.*  \*
- e. Has a *de minimis* impact finding been prepared for the project? *If yes, attach the finding.* \*
- f. Has a Programmatic Section 4(f) Evaluation been prepared for the project? *If yes, attach the evaluation.* \*
- g. Has an Individual Section 4(f) Evaluation been prepared for the project? *If yes, attach the evaluation.* \*

**2. Section 6(f) (36 CFR 59)**

- a. Were funds from the Land and Water Conservation Fund Act (LWCFA) used for improvement to a property that will be affected by this project?
- b. Is the use of the property receiving LWCFA funds a “conversion of use” per Section 6(f) of the LWCFA? *Attach the correspondence received from the ADNR 6(f) Grants Administrator.*

**3. Summarize Section 4(f)/6(f) involvement, if any:**

A cultural resource site (FAI-02398) determined to be eligible for the National Register of Historic Places is located within the project area and qualifies as a Section 4(f) property. Project work adjacent to the site includes repaving and new and improved ditching. No Section 4(f) involvement is proposed and complete avoidance of the Section 4(f) property will be facilitated through an environmental commitment to provide standoff fencing, as required for a finding of no adverse impact for this site. On September 28, 2018 a no use determination was made by DOT&PF for this property, therefore the requirements of Section 4(f) do not apply. See Appendix H.

**III. Permits and Authorizations****N/A YES NO**

1. USACE, Section 404/10 Includes Abbreviated Permit Process, Nationwide Permit, and General Permit
2. Coast Guard, Section 9
3. ADF&G Fish Habitat Permit ([Title 16.05.871](#) and [Title 16.05.841](#))
4. Flood Hazard
5. ADEC Non-domestic Wastewater Plan Approval
6. ADEC 401

**III. Permits and Authorizations**

N/A    YES    NO

- 7. ADEC APDES
- 8. Noise
- 9. Eagle Permit
- 10. Other. If yes, list below.

**IV. Comments and Coordination**

N/A    YES    NO

- 1. Public/agency involvement for project. *Required if protected resources are involved.*
- 2. Public Meetings. Date(s):  
  - February 8, 2018: Meeting with Doyon, Limited and DOT&PF.
  - February 15, 2018: Public Open House.
- 3. Newspaper ads. *Attach certified affidavit of publication as an appendix.*     
 Name of newspaper and date: Fairbanks Daily News-Miner: February 1, 2018 & February 12, 2018.
- 4. Alaska Online Public Notice date: February 1, 2018
- 5. Agency scoping letters. Date sent: December 23, 2015
- 6. Agency scoping meeting. Date of meeting: \_\_\_\_\_
- 7. Field review. Date: \_\_\_\_\_
- 8. Summarize comments and coordination efforts for this project. Discuss pertinent issues raised. *Attach correspondence that demonstrates coordination and that there are no unresolved issues.*

Public and agency comment summaries can be found in Appendices G and H, respectively. There were no unresolved issues. DOT&PF responses to public and agency comments were provided to commenters. An abbreviated summary of the primary issues raised by the public during public scoping efforts and the Department's responses to the issues are provided in the table below:

Category	Comment	DOT&PF Response
Curves	Multiple hazardous curves are present within the area.	Curves within the project area will be realigned to meet current design standards for curvature and grade with the preferred alternative.
Sight Distance	Insufficient sight distance within some areas of the project.	Areas will be reconstructed and vegetation will be managed to ensure adequate sight distance.
Passing Lanes	Passing lanes are needed in project area, and proposed passing lanes conflict with local land use in some areas.	Passing lanes have been added to the project area, and proposed passing lanes have been revised to better match the area setting.
Rest Areas	Closed rest areas are being used due to year-round signage, and the rest area at MP 315 is a local nuisance.	M&O has been notified of the year-round use of the seasonal rest areas. Alterations to the existing rest area at MP 315 is not within the scope of this project.

**V. Environmental Commitments and Mitigation Measures**

List all environmental commitments and mitigation measures included in the project.

- Prehistoric site located within APE. DOT&PF will install temporary fencing under the terms of the recommendation by NLURA. No equipment or personnel associated with this project will be allowed beyond the fences perimeter. The installation of the fencing will be monitored by the Northern Region PQI. Periodic site visits that will include written and photographic documentation to the project files will be done by the Northern Region PQI during construction, and the fencing will be removed at the conclusion of the work under the PQI's supervision.
- The Department will adhere to the USFWS guidance on avoiding vegetation clearing during the recommended bird nesting window as supplied by the USFWS (May 1 – July 15).
- Bald and/or Golden Eagle nests are not currently known to exist within the vicinity (within a half mile) of the project, though there is a known eagle nest 2 miles from the project area. If an eagle nest is identified within a half mile of the project area, the Department will contact the USFWS for further assistance.
- There is a known contaminated site at MP 321, the Department will contact ADEC Spill Prevention and Response if contamination is encountered from this site.
- Implemented measures to minimize and control the spread of invasive species will be defined in the Erosion and Sediment Control Plan (ESCP). Standard contract specifications such as seeding disturbed areas with certified weed-free native, perennial grass seed mixtures will help minimize erosion as well as the establishment of invasive weed species.
- The conditions stipulated in the 2016 Alaska Pollutant Discharge Elimination System Construction General Permit will be adhered to during project construction.

**VI. Environmental Documentation Approval**

N/A    YES    NO

1. Do any unusual circumstances exist, as described in 23 CFR 771.117(b)? *If yes, attach consultation with the NEPA Program Manager demonstrating that a CE is appropriate.*

\*   

2. The project meets the criteria of one of the following DOT&PF Programmatic Approvals authorized in the Nov. 13, 2017 "Chief Engineer Directive – Programmatic Categorical Exclusions".

- *If yes, select the appropriate Programmatic Approval below, and the CE documentation form may be approved by the Regional Environmental Manager.*
- *If no, the CE documentation form must be approved by a NEPA Program Manager.*

a. Programmatic Approval 1

b. Programmatic Approval 2

c. Programmatic Approval 3

**VII. Environmental Documentation Approval Signatures**

Prepared by:

  
\_\_\_\_\_

[Signature] Environmental Impact Analyst

Laura Sample

Date:

11/14/2018

**VII. Environmental Documentation Approval Signatures**

Reviewed by:  Date: 11/14/2018  
[Signature] Engineering Manager

Lauren Little  
[Print Name] Engineering Manager

**Programmatic CE**

Approved by: \_\_\_\_\_ Date: \_\_\_\_\_  
[Signature] Regional Environmental Manager

\_\_\_\_\_  
[Print Name] Regional Environmental Manager

**Non-Programmatic CE**

Approval Recommended by:  Date: 11-14-18  
[Signature] Regional Environmental Manager

Brett Nelson  
[Print Name] Regional Environmental Manager

Approved by:  Date: 11/14/18  
[Signature] NEPA Program Manager

Melissa Goldstein  
[Print Name] NEPA Program Manager



**Appendix C**  
**TRAFFIC ANALYSES**

S.O. No. 60657 PARKS HWY 305-325 RECON

Subject: CLIMBING LANE WARRANT

MP 315-325

Sheet No. 1 of 2

Drawing No. \_\_\_\_\_

Computed by REH

Checked by MJM

Date MARCH 12, 2018

PARKS HIGHWAY VERTICAL ALIGNMENT (NB) FROM LITTLE GOLDSTREAM BRIDGE NO. 678 (MP 315.5) TO MP 319

- 1) CLIMBS @ 4% FOR APPROX 7000 FT
- 2) FLATTENS @ 0.5% FOR APPROX 950 FT
- 3) CLIMBS @ 5% FOR APPROX 3650 FT
- 4) FLATTENS @ 0.3% FOR APPROX 1850 FT
- 5) CLIMBS @ 5% FOR APPROX 1800 FT
- 6) DROPS @ -2.3% FOR APPROX 1800 FT
- 7) CLIMBS @ 5% FOR APPROX 2300 FT
- 8) FLATTENS @ 0.25% FOR APPROX 900 FT
- 9) CLIMBS @ 3.25% FOR APPROX 1000 FT

BASED ON FIG 3-28 FROM THE GREEN BOOK A CLIMBING LANE IS ADVANTAGOUS CRITICAL LENGTHS

TRUCK SPEED REDUCTION	GRADE	CRITICAL LENGTH
10 MPH	4%	1,200 FT
15 MPH	4%	1,950 FT
10 MPH	5%	1,000 FT
15 MPH	5%	1,500 FT

RESULTING IN ALIGNMENT SEGMENTS 1, 3, & 7 WARRANT CLIMBING LANES.

DUE TO THE LIMITED DISTANCE BETWEEN SEGMENTS IT IS RECOMMENDED A CLIMBING LANE EXTENDS FROM MP 316 TO 319

S.O. No. 00657 PARKS Hwy 305-325 RECON

Subject: CLIMBING LANE WARRANTS

Sheet No. 2 of 2

Drawing No. \_\_\_\_\_

Computed by RET Checked by MJM Date MARCH 12, 2018

FROM MP 320 TO MP 322

- 10) DOWN @ 2.28% FOR APPROX 3450 FT
- 11) CLIMBS @ 5% FOR APPROX 5600 FT
- 12) DOWN @ 2.87% FOR APPROX 2850 FT
- 13) CLIMBS @ 4% FOR APPROX 2600 FT

RESULTING IN ALIGNMENT SEGMENT II WARRANTING A CLIMBING LANE.

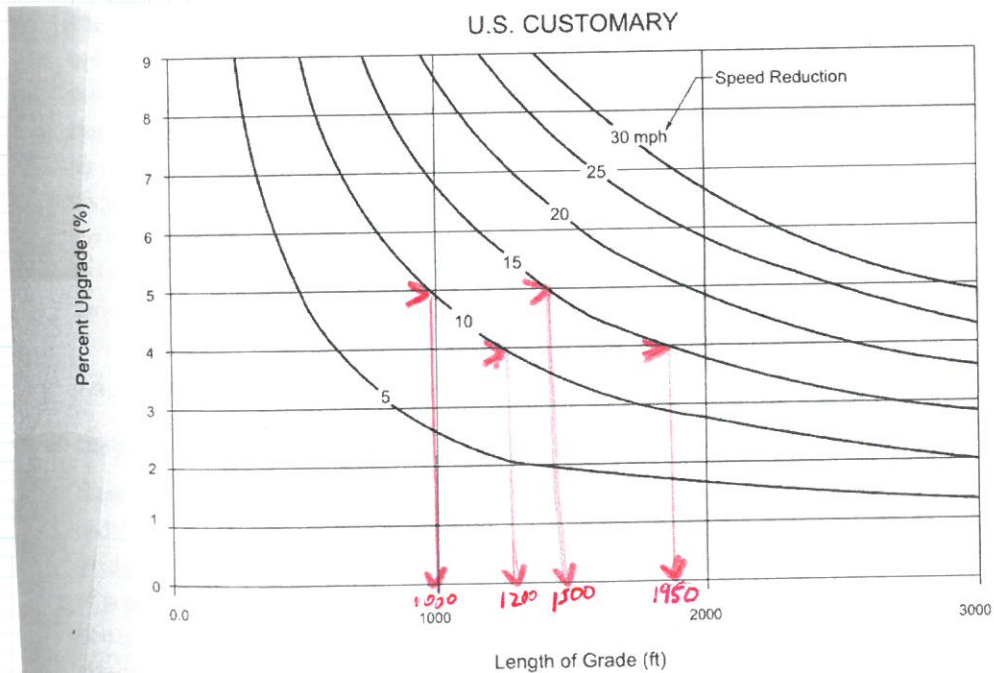

Figure 3-28. Critical Lengths of Grade for Design, Assumed Typical Heavy Truck of 120 kg/kW [200 lb/hp], Entering Speed = 110 km/h [70 mph]

**Appendix D**  
**PAVEMENT DESIGN**



Project: Parks Hwy MP 305-325 Proj No.: Z606570000/0A45028							New Construction by:Hebnes 3/5/2019 02:54:34 PM			
AADT = 1,800	Past Loadings	Future Loadings						X/Y Load Locations (in): Load = 4500 (lbs) Tire Pressure = 110 (psi)	0 0	13.5 0
10% Spring 40% Summer 10% Fall 40% Winter ----- Total:	-----	153070 612279 153070 612279 ----- 1,530,697						X/Y Evaluation Points (in):	6.75 0	0 0
Layer	Critical Z Coordinate	Asphalt Properties	Season	Modulus (ksi)	Poisson's Ratio	Tensile Critical Micro Strain	Critical Compressive Stress (psi)	Million Cycles to Failure	Future Damage %	Total Damage %
3(in) Asphalt_Concrete	2.99	4% Air 5.5% Asph 148 pcf	Spring	755	0.3	106		20.78	0.74	0.74%
			Summer	510	0.3	70.2		112.76	0.54	0.54%
			Fall	510	0.3	55.4		245.78	0.06	0.06%
			Winter	1,500	0.3	44.8		196.77	0.31	0.31%
Total Damage:								1.65	1.65	
3(in) 4-5% Asph_Treated_Base	5.99	6% Air 4.5% Asph 145 pcf	Spring	250	0.35	232		0.95	16.15	16.15%
			Summer	300	0.35	202		1.28	47.85	47.85%
			Fall	350	0.35	175		1.80	8.51	8.51%
			Winter	500	0.4	89.1		12.23	5.01	5.01%
Total Damage:								77.52	77.52	
8(in) elect_A_P200<6%	6.01		Spring	25	0.4		13.90	2.67	5.72	5.72%
			Summer	35	0.4		17.00	4.16	14.74	14.74%
			Fall	35	0.4		17.80	3.58	4.28	4.28%
			Winter	90	0.4		17.80	77.74	0.79	0.79%
Total Damage:								25.53	25.53	
12(in) elect_B_P200<10%	14.01		Spring	15	0.4		7.12	3.57	4.29	4.29%
			Summer	30	0.4		6.84	48.90	1.25	1.25%
			Fall	80	0.4		8.52	584.81	0.03	0.03%
			Winter	80	0.4		6.26	1,597.40	0.04	0.04%
Total Damage:								5.61	5.61	
S-Infinite ubgrade_P200>30	26.01		Spring	45	0.45		4.31	826.51	0.02	0.02%
			Summer	10	0.45		2.41	26.31	2.33	2.33%
			Fall	10	0.45		2.03	46.04	0.33	0.33%
			Winter	10	0.45		1.44	141.02	0.43	0.43%
Total Damage:								3.11	3.11	

Reduced structural section design

OK Jeff Currey, P.E., NR Mat'ls Engr 12-16-19



Project: Parks Hwy MP 305-325 Proj No.: Z606570000/QA45028							New Construction by:Hebnes 3/5/2019 03:27:42 PM				
AADT = 1,800	Past Loadings	Future Loadings						X/Y Load Locations (in): Load = 4500 (lbs) Tire Pressure = 110 (psi)	0 0	13.5 0	
10% Spring 40% Summer 10% Fall 40% Winter ----- Total:	-----	153070 612279 153070 612279 ----- 1,530,697							X/Y Evaluation Points (in):	6.75 0	0 0
Layer	Critical Z Coordinate	Asphalt Properties	Season	Modulus (ksi)	Poisson's Ratio	Tensile Critical Micro Strain	Critical Compressive Stress (psi)	Million Cycles to Failure		Future Damage %	Total Damage %
3(in) Asphalt_Concrete	2.99	4% Air 5.5% Asph 148 pcf	Spring	755	0.3	106		20.78		0.74	0.74%
			Summer	510	0.3	70.7		110.15		0.56	0.56%
			Fall	510	0.3	57.4		218.71		0.07	0.07%
			Winter	1,500	0.3	44.9		195.34		0.31	0.31%
								Total Damage:	1.68	1.68	
3(in) 4-5% Asph_Treated_Base	5.99	6% Air 4.5% Asph 145 pcf	Spring	250	0.35	237		0.88		17.32	17.32%
			Summer	300	0.35	197		1.39		44.07	44.07%
			Fall	350	0.35	169		2.02		7.59	7.59%
			Winter	500	0.4	85.2		14.17		4.32	4.32%
								Total Damage:	73.30	73.30	
8(in) select_A_P200<6%	6.01		Spring	25	0.4		13.60	2.87		5.33	5.33%
			Summer	35	0.4		17.40	3.85		15.90	15.90%
			Fall	35	0.4		18.40	3.21		4.77	4.77%
			Winter	90	0.4		18.40	69.77		0.88	0.88%
								Total Damage:	26.87	26.87	
28(in) select_B_P200<10%	14.01		Spring	15	0.4		6.43	4.97		3.08	3.08%
			Summer	30	0.4		7.75	32.54		1.88	1.88%
			Fall	80	0.4		10.20	325.24		0.05	0.05%
			Winter	80	0.4		7.87	757.48		0.08	0.08%
								Total Damage:	5.09	5.09	
S-Infinite subgrade_P200>30	42.01		Spring	45	0.45		2.14	8,100.23		0.00	0.00%
			Summer	10	0.45		1.18	269.90		0.23	0.23%
			Fall	10	0.45		0.90	662.23		0.02	0.02%
			Winter	10	0.45		0.69	1,530.19		0.04	0.04%
								Total Damage:	0.29	0.29	

Full structural section design

Project Name: Parks Hwy MP 305-325 Reconstruction Designer: Little  
 Project Number: Z606570000 Date: 2/4/19

## Traffic Data for Design and Historic ESALs

### Design Data Input

Design Construction Year:	2025
Design Length in Years:	15
Base Year:	2016
Base Year Total AADT:	1800
Growth Rate % per Year:	1.25
% of Base Year AADT for Each Lane	
Lane	%
1	35
2	65
3	0
4	0
5	0
6	0

### Historic Data Input

Historic Construction Year:	
Backcast % per Year:	
% of Base Year AADT for Each Lane	
Lane	%
1	
2	
3	
4	
5	
6	

Truck Category	Load Factor (ESALs per Truck)	% AADT in Truck Category	Truck Category	Load Factor (ESALs per Truck)	% AADT in Truck Category
2-Axle	0.5	6.5	2-Axle	0.5	
3-Axle	0.85	1.2	3-Axle	0.85	
4-Axle	1.2	0.5	4-Axle	1.2	
5-Axle	1.55	2.4	5-Axle	1.55	
>=6-Axle	2.24	4.9	>=6-Axle	2.24	

#### TOTAL DESIGN ESALS:

**1,530,697**

#### TOTAL HISTORIC ESALS:

-

### Construction Year ESAL Calculations

Truck Category	Design Lane AADT	% AADT in Truck Category	Load Factor for Truck Category	Construction Year ESALs
2-Axle	1308	6.5	0.5	15,516
3-Axle	1308	1.2	0.85	4,870
4-Axle	1308	0.5	1.2	2,865
5-Axle	1308	2.4	1.55	17,760
>=6-Axle	1308	4.9	2.24	52,402
Total Construction Year ESALs:				93,413

### Historic Construction Year ESAL Calculations

Truck Category	Design Lane AADT	% AADT in Truck Category	Load Factor for Truck Category	Historic Construction Year ESALs
2-Axle		0	0.5	0
3-Axle		0	0.85	0
4-Axle		0	1.2	0
5-Axle		0	1.55	0
>=6-Axle		0	2.24	0
Total Historic Construction Year ESALs:				0

[CLICK HERE FOR MORE INFORMATION ON ESAL CALCULATIONS](#)

**Appendix E**  
**PRELIMINARY PLAN AND PROFILE SHEETS**



STATE	PROJECT DESIGNATION	YEAR	SHEET NO.	TOTAL SHEETS
ALASKA	0A45028/Z606570000	2020	F1	39

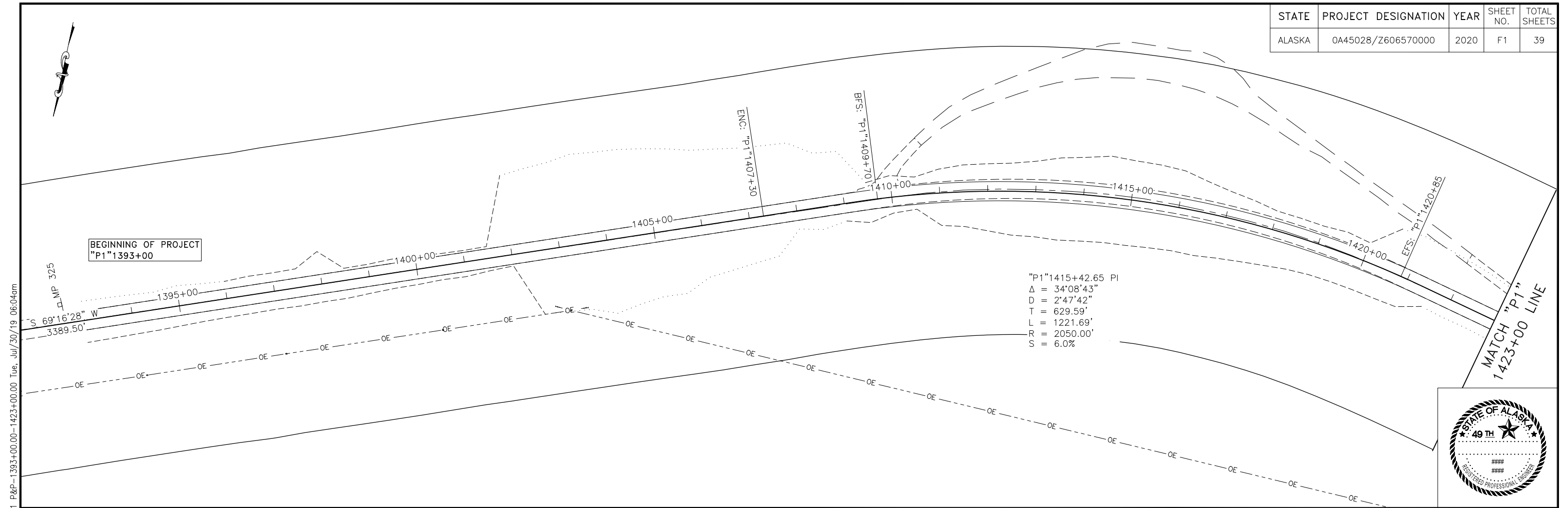

\\MANHFS1.bkr.mbakercorp.com\PROJECTS\_AKDOT\148830 - DOT&PF Parks 305-325 P\04 CADD\Prelim Eng\Alt P1\60657\_CM\_P1 P&P-1393+00.00-1423+00.00 Tue, Jul/30/19 06:04am

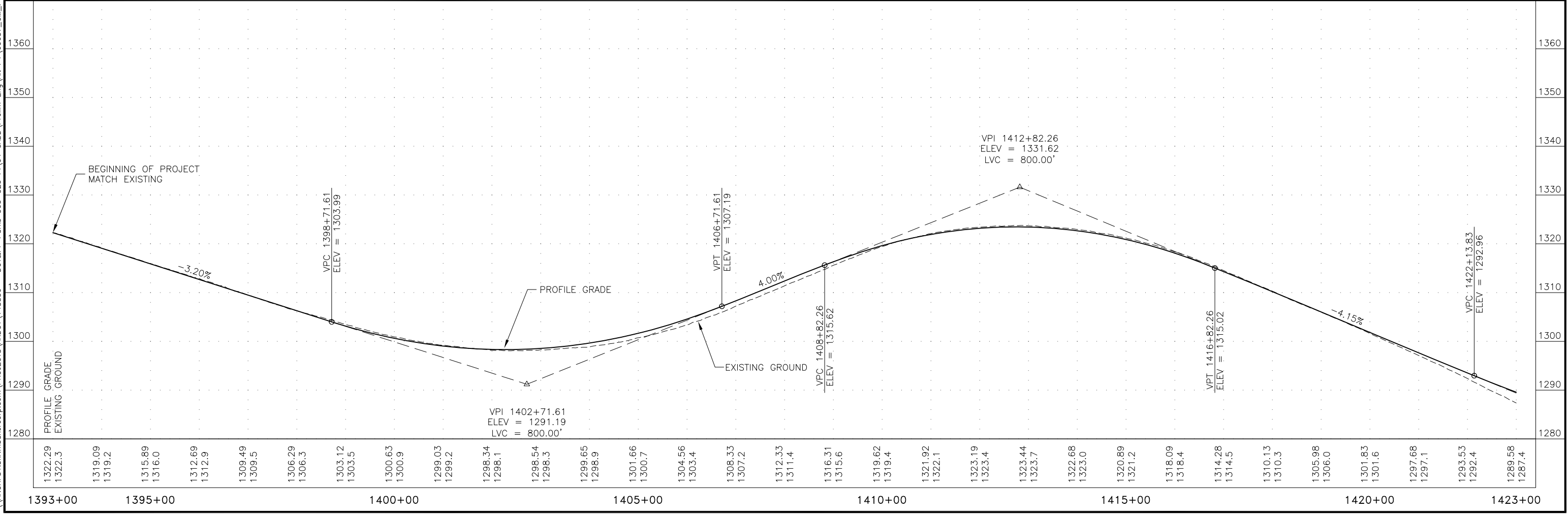

STATE	PROJECT DESIGNATION	YEAR	SHEET NO.	TOTAL SHEETS
ALASKA	0A45028/Z606570000	2020	F2	39

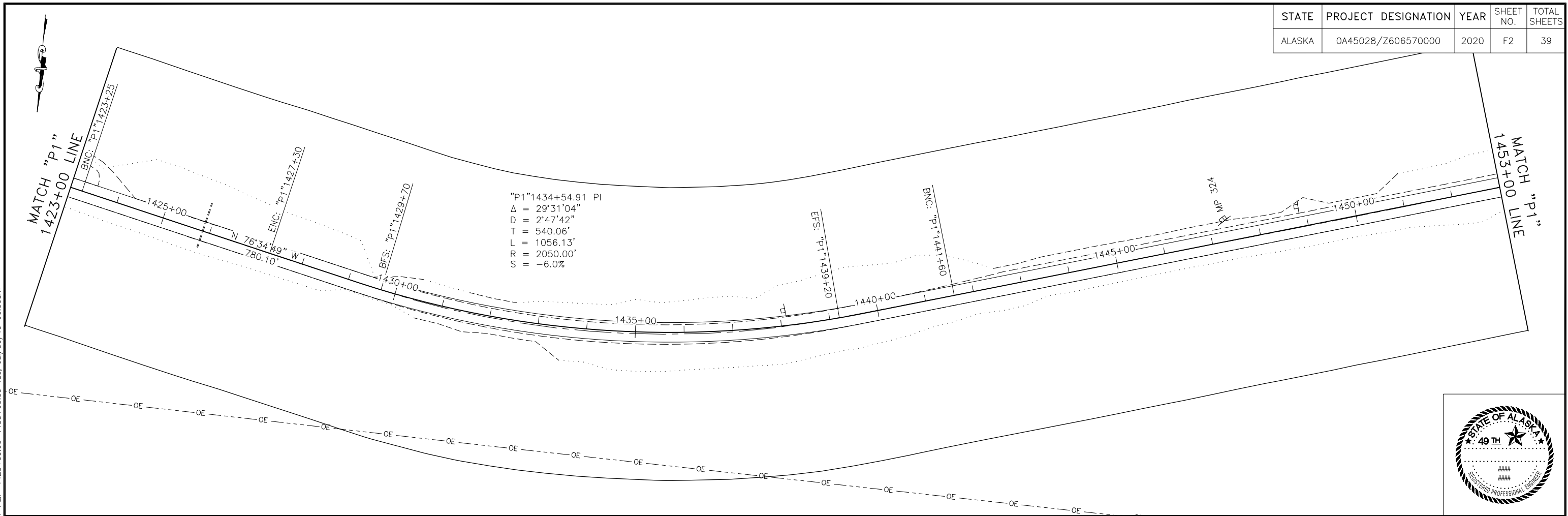

\\ANCFST1.bkr.mbakercorp.com\PROJECTS\_AKDOT\148830 - DOT&PF Parks 305-325 PI\04 CADD\Prelim Eng\Alt P1\60657\_CM\_P1 P&P-1423+00.00-1453+00.00 Tue, Jul/30/19 06:06am

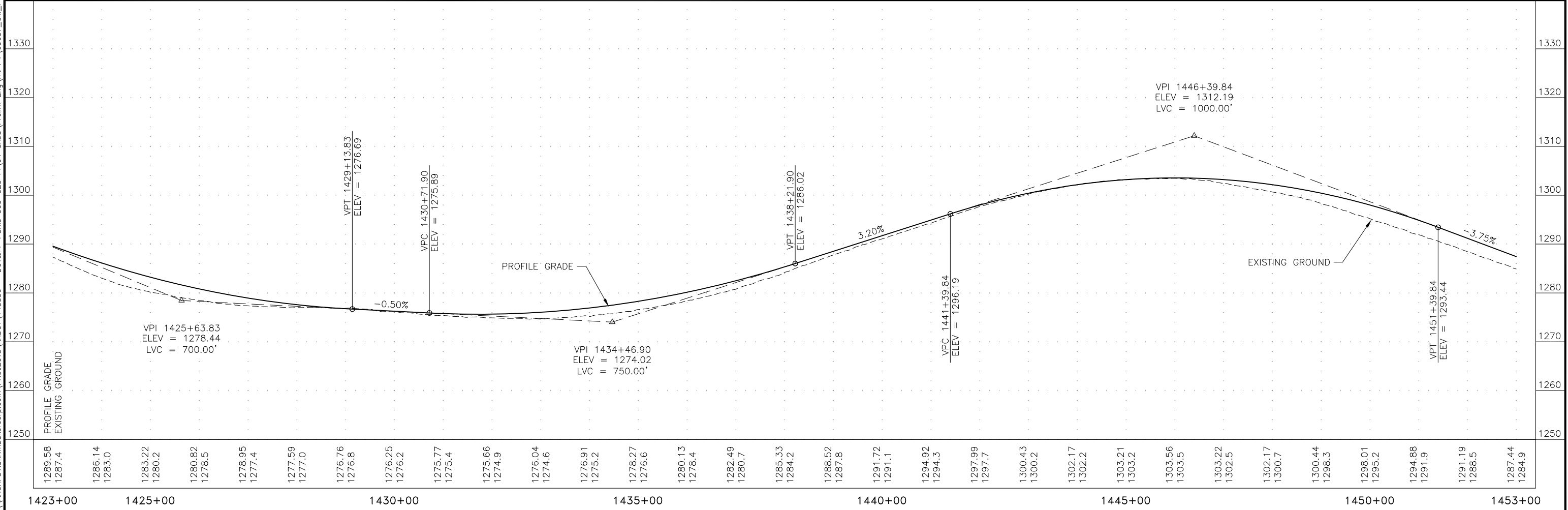

STATE	PROJECT DESIGNATION	YEAR	SHEET NO.	TOTAL SHEETS
ALASKA	0A45028/Z606570000	2020	F3	39

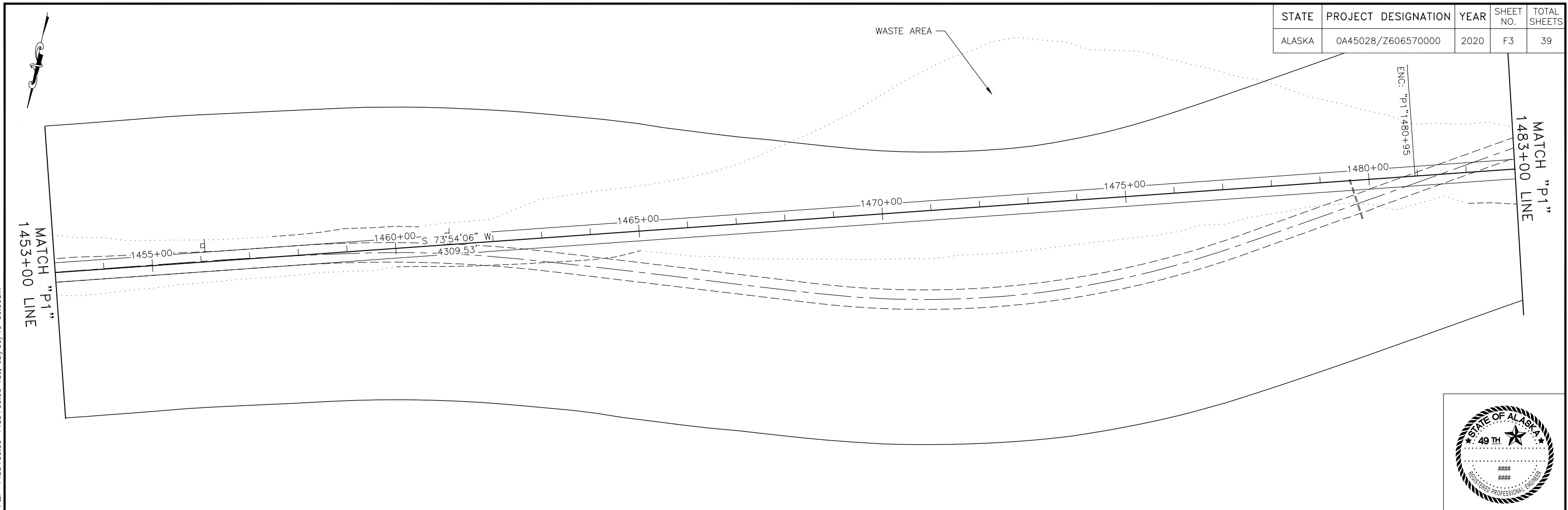

\\MANHFS1.bkr.mbakercorp.com\PROJECTS\AKDOT\148830 - DOT&PF Perks 305-325 P\04 CADD\Prelim Eng\Alt P1\60657\_CM\_P1 P&P-1453+00.00-1483+00.00 Tue, Jul/30/19 06:06am

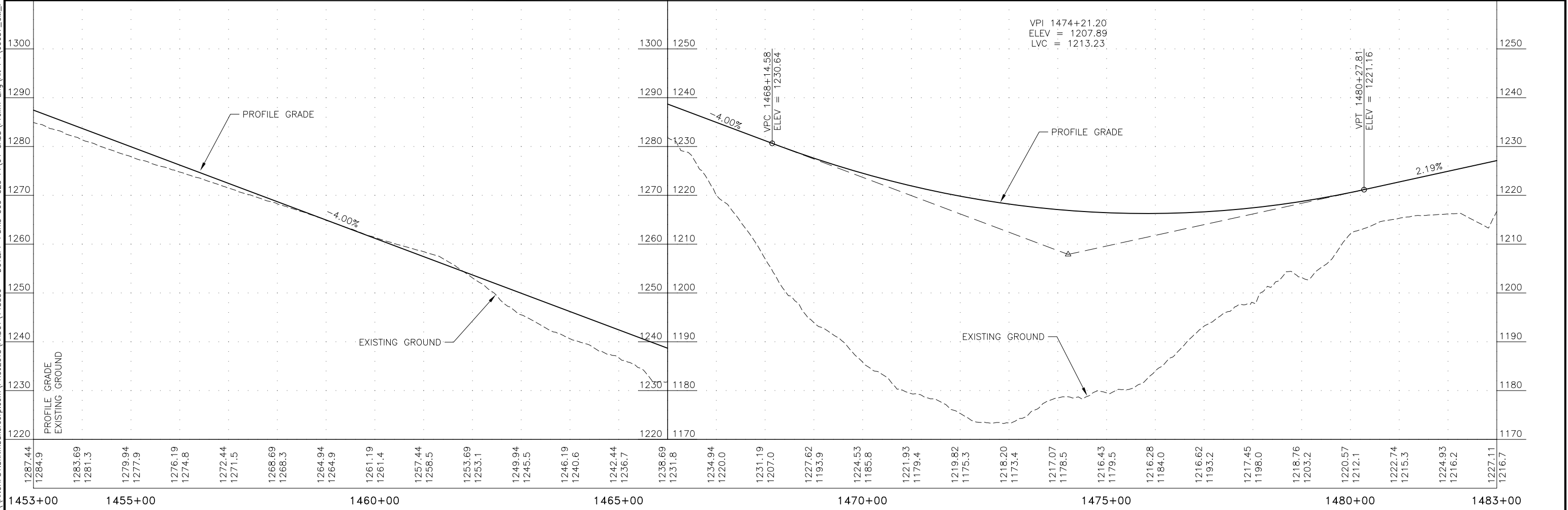

STATE	PROJECT DESIGNATION	YEAR	SHEET NO.	TOTAL SHEETS
ALASKA	0A45028/Z606570000	2020	F4	39



\\MANHFS1.bkr.mbakercorp.com\PROJECTS\_AKDOT\148830 - DOT&PF Parks 305-325 P\04 CADD\Prelim Eng\Alt P1\60657\_CM\_P1 P&P-1483+00.00-1513+00.00 Tue, Jul/30/19 06:07am

"P1"1489+10.21 PI  
 $\Delta = 33^{\circ}23'03''$   
 $D = 2'43'42''$   
 $T = 629.71'$   
 $L = 1223.59'$   
 $R = 2100.00'$   
 $S = 6.0\%$

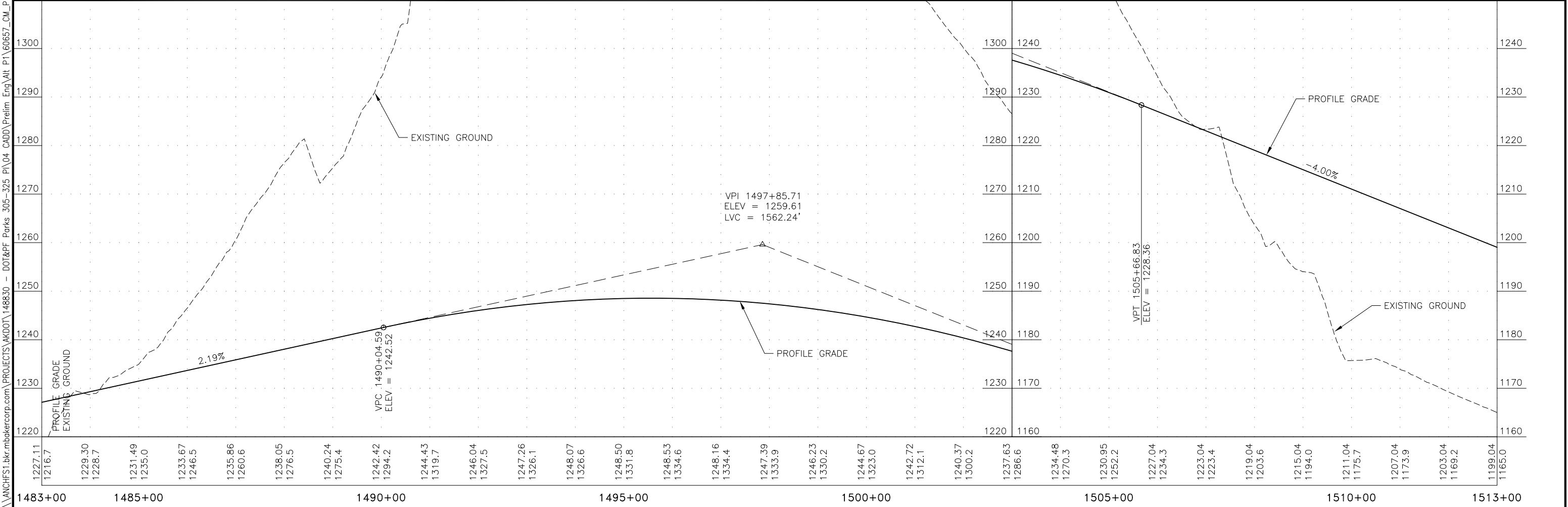



STATE	PROJECT DESIGNATION	YEAR	SHEET NO.	TOTAL SHEETS
ALASKA	0A45028/Z606570000	2020	F5	39

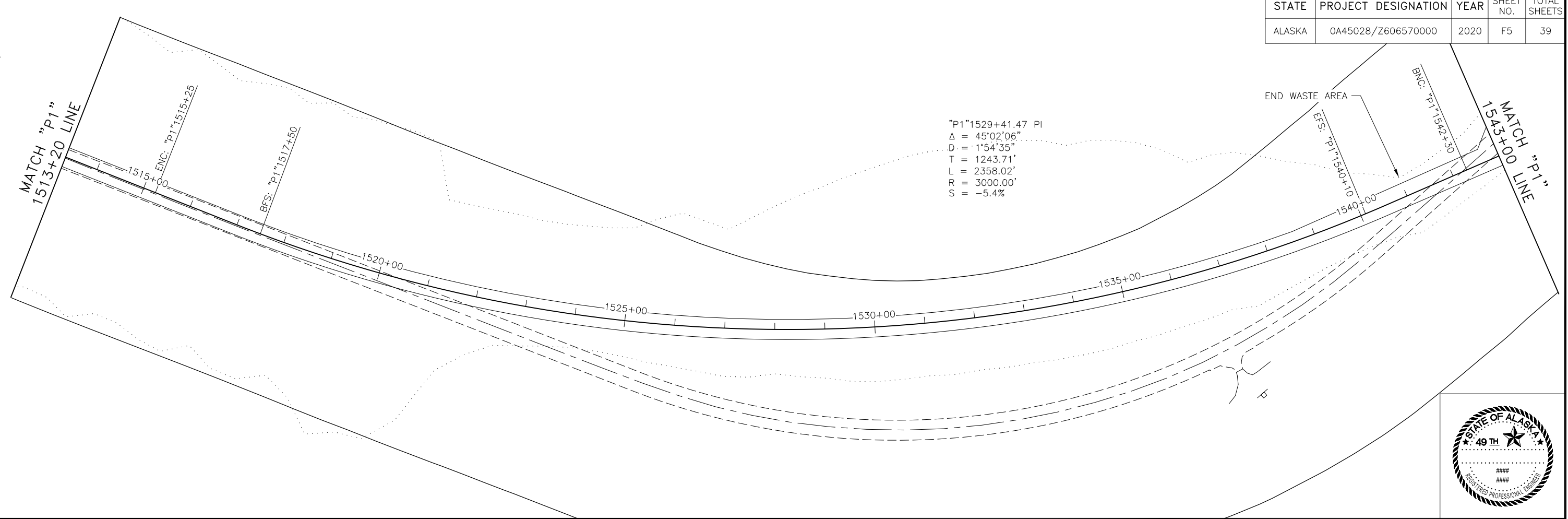

\\MANHFS1.bkr.mbakercorp.com\PROJECTS\AKDOT\148830 - DOT&PF Parks 305-325 P\04 CADD\Prelim Eng\Alt P1 60657\_CM\_P1 P&P-1513+00.00-1543+00.00 Tue, Jul/30/19 06:08am

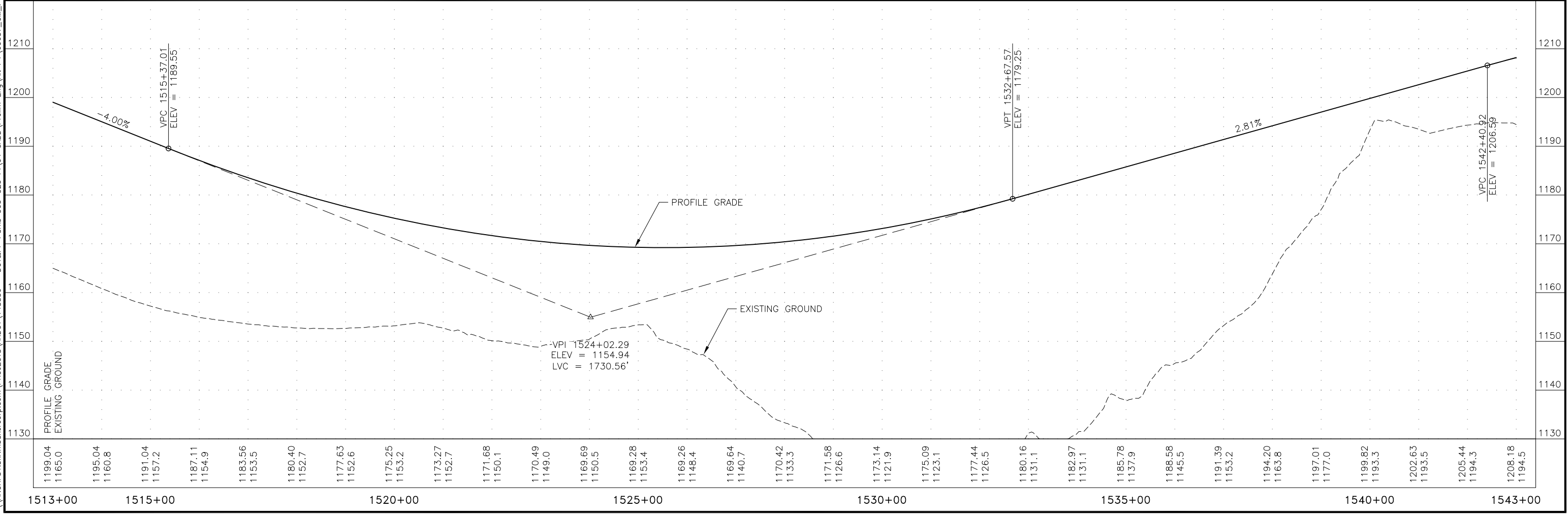

STATE	PROJECT DESIGNATION	YEAR	SHEET NO.	TOTAL SHEETS
ALASKA	0A45028/Z606570000	2020	F6	39

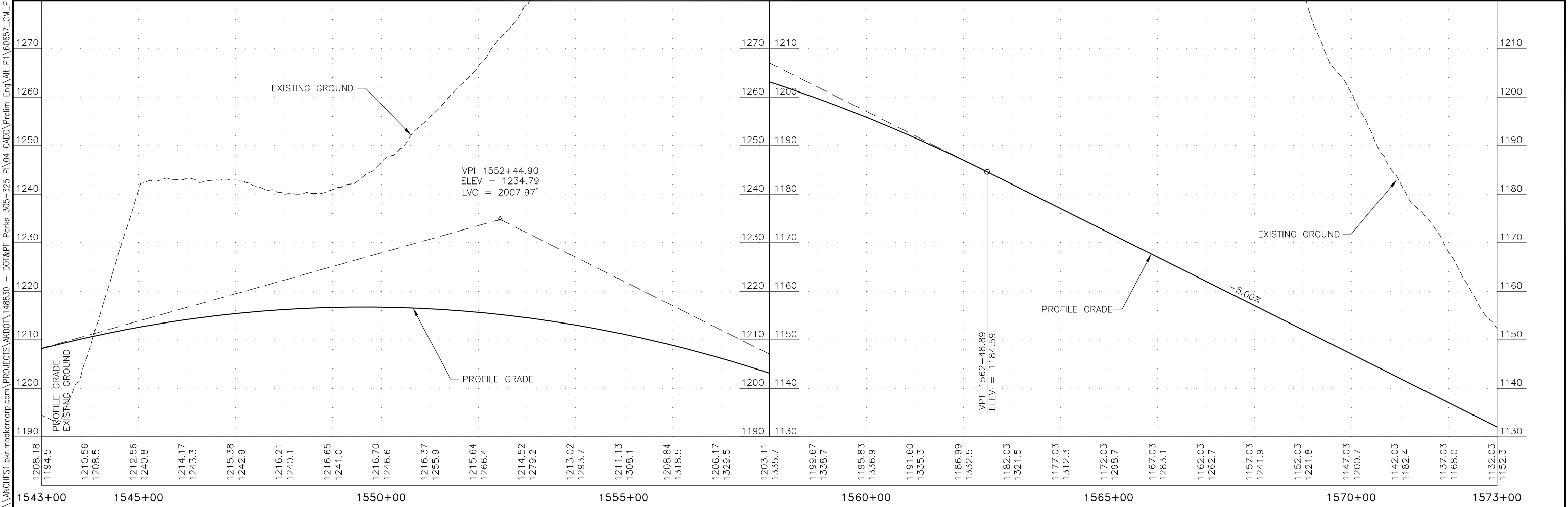
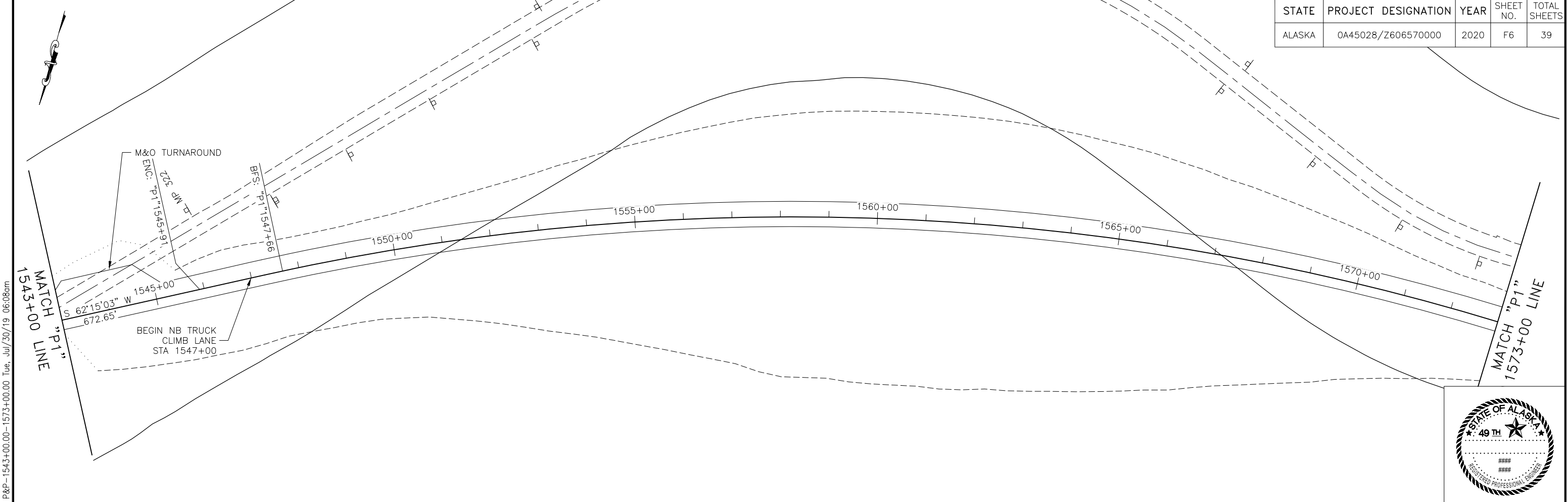

\\MANHFS1.bkr.mbakercorp.com\PROJECTS\AKDOT\148830 - DOT&PF Perks 305-325 P\04 CADD\Prelim Eng\Alt P1\60657\_CM\_P1 P&P-1543+00.00-1573+00.00 Tue, Jul/30/19 06:08am

STATE	PROJECT DESIGNATION	YEAR	SHEET NO.	TOTAL SHEETS
ALASKA	0A45028/Z606570000	2020	F7	39

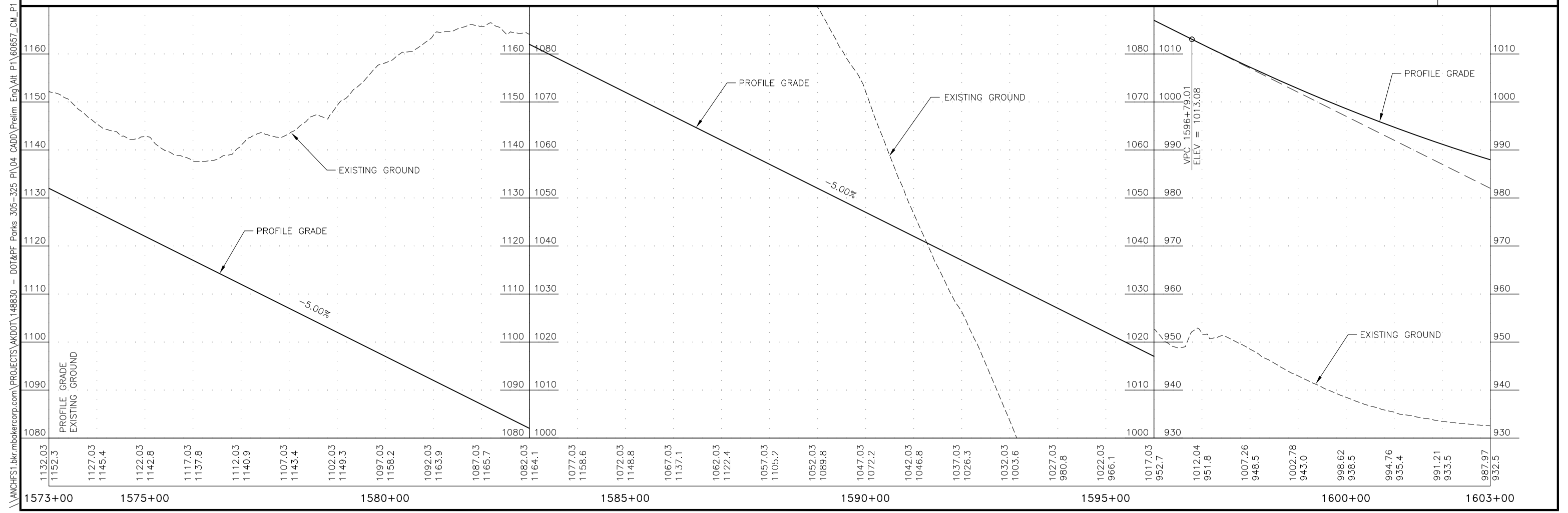
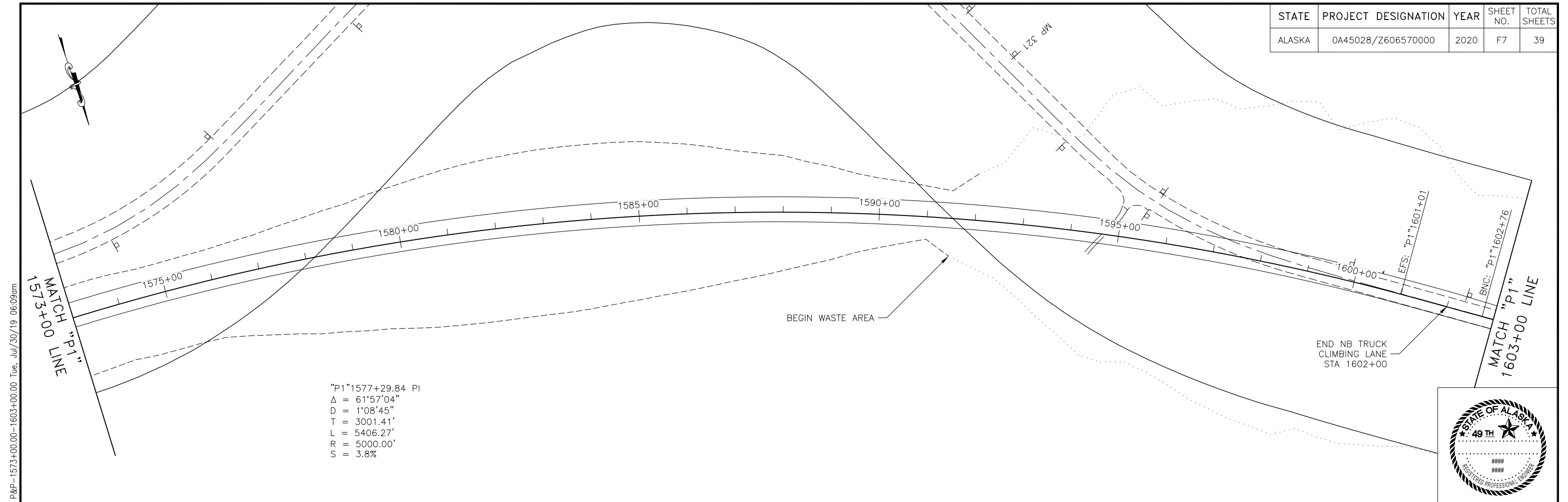

\\MANHFS1.bkr.mbakercorp.com\PROJECTS\AKDOT\148830 - DOT&PF Perks 305-325 P\04 CADD\Prelim Eng\Alt P1\60657\_CM\_P1 P&P-1573+00.00-1603+00.00 Tue, Jul/30/19 06:09am



STATE	PROJECT DESIGNATION	YEAR	SHEET NO.	TOTAL SHEETS
ALASKA	0A45028/Z606570000	2020	F8	39

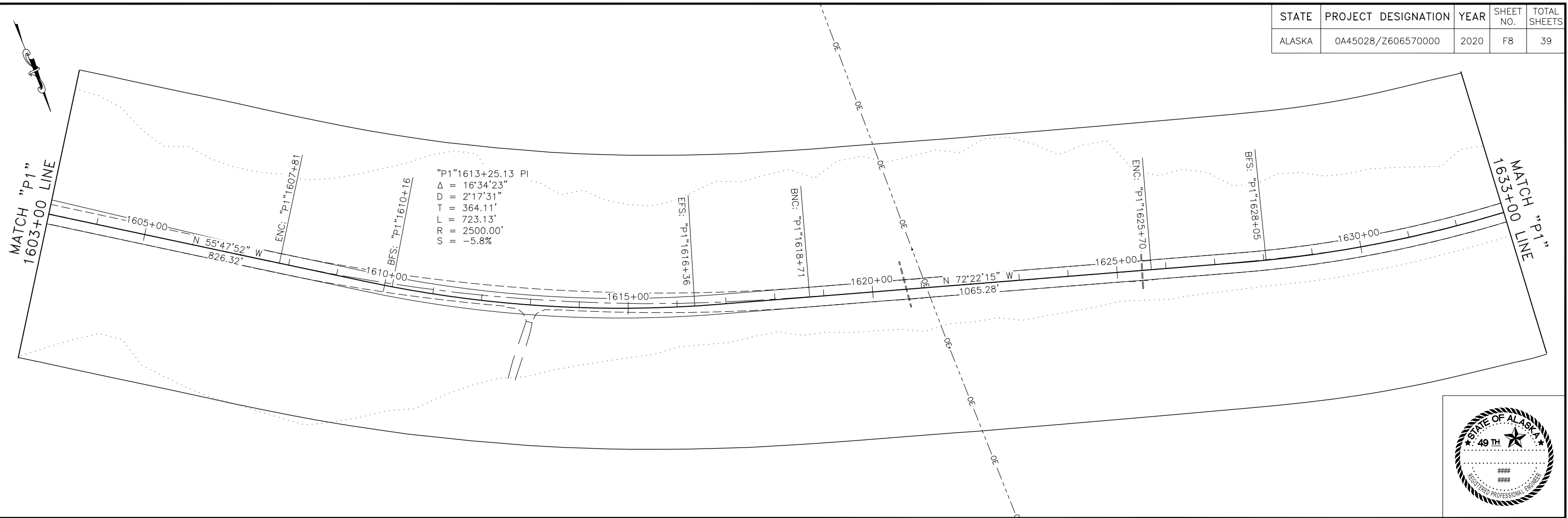

\\MANHFS1.bkr.mbakercorp.com\PROJECTS\AKDOT\148830 - DOT&PF Parks 305-325 P\04 CADD\Prelim Eng\Alt P1 60657\_CM\_P1 P&P-1603+00.00-1633+00.00 Tue, Jul/30/19 06:10am

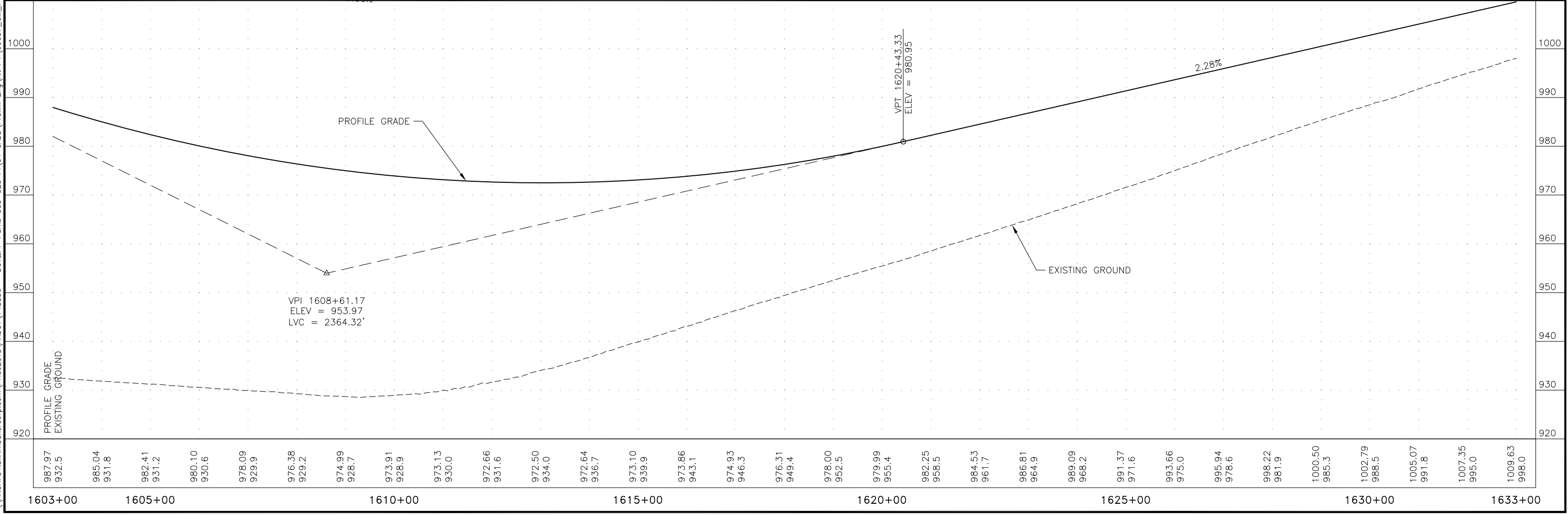



STATE	PROJECT DESIGNATION	YEAR	SHEET NO.	TOTAL SHEETS
ALASKA	0A45028/Z606570000	2020	F9	39

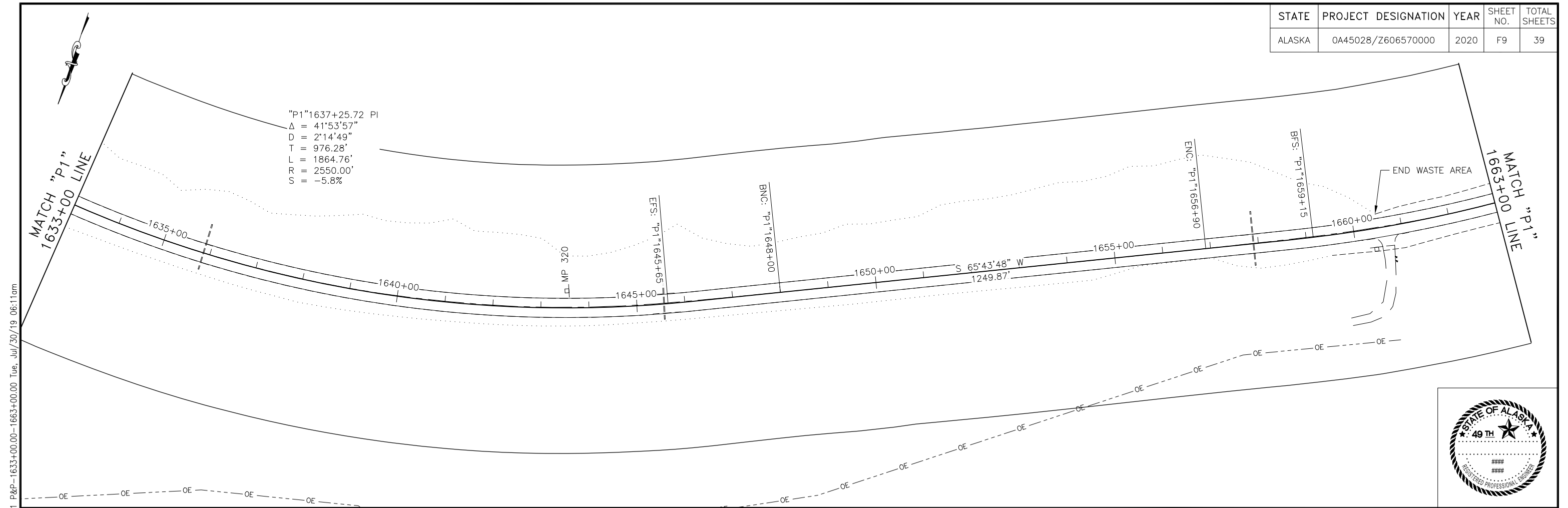

\\MANHFS1.bkr.mbakercorp.com\PROJECTS\_AKDOT\148830 - DOT&PF Parks 305-325 P\04 CADD\Prelim Eng\Alt P1\60657\_CM\_P1 P&P-1633+00.00-1663+00.00 Tue, Jul/30/19 06:11am

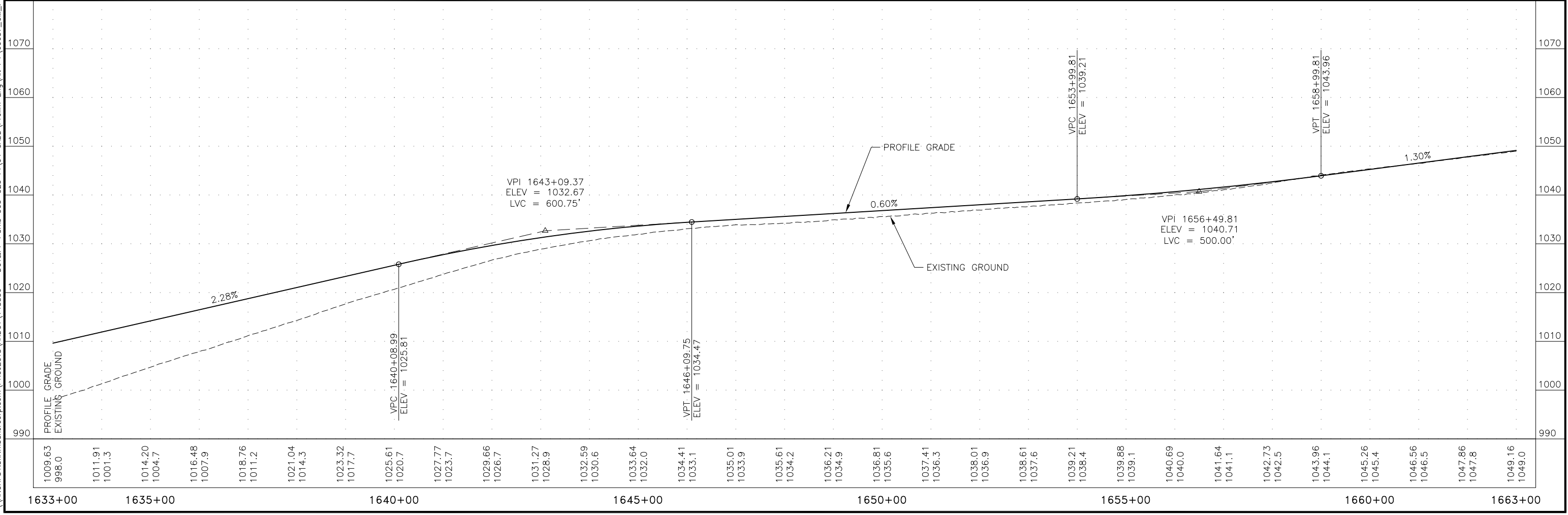

STATE	PROJECT DESIGNATION	YEAR	SHEET NO.	TOTAL SHEETS
ALASKA	0A45028/Z606570000	2020	F10	39

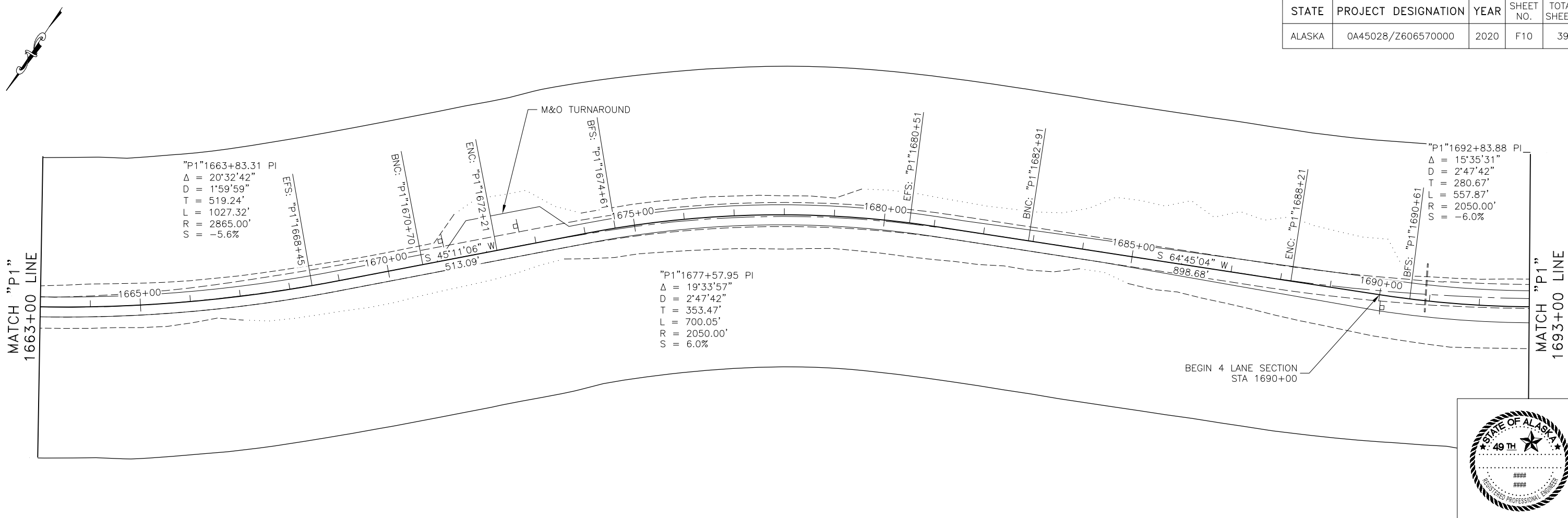

\\MANHFS1.bkr.mbakercorp.com\PROJECTS\AKDOT\148830 - DOT&PF Parks 305-325 P\04 CADD\Prelim Eng\Alt P1\60657\_CM\_P1 P&P-1663+00.00-1693+00.00 Tue, Jul/30/19 06:12am

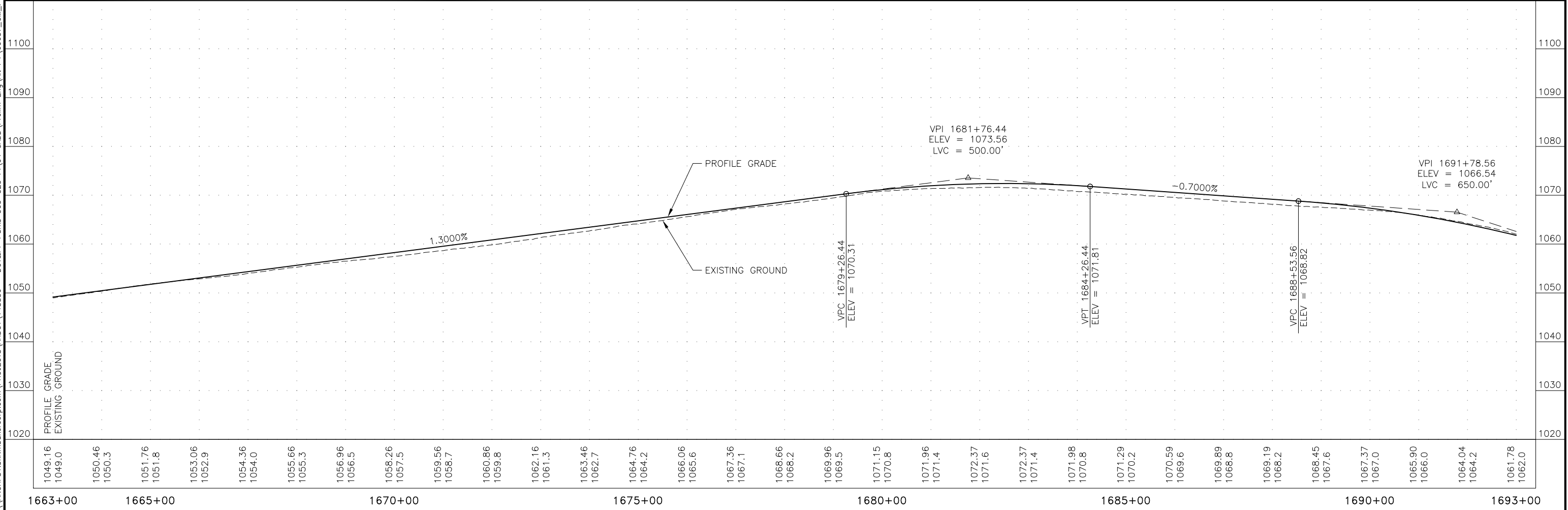

STATE	PROJECT DESIGNATION	YEAR	SHEET NO.	TOTAL SHEETS
ALASKA	0A45028/Z606570000	2020	F11	39

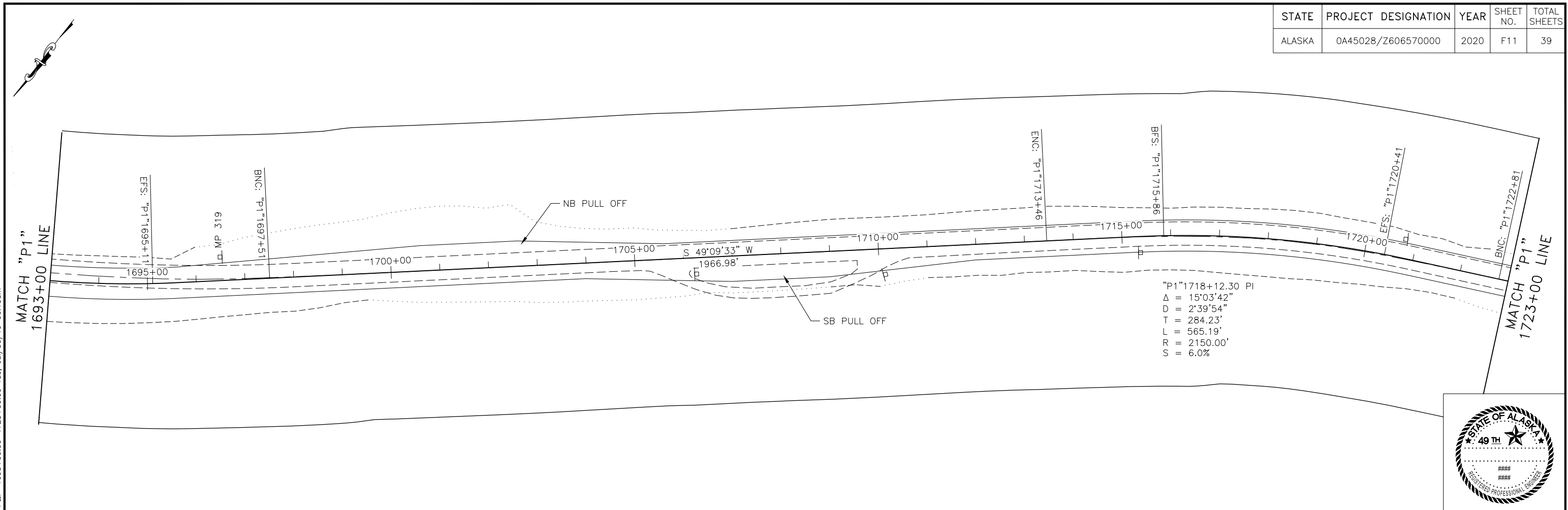

\\MANHES1.bkr.mbakercorp.com\PROJECTS\AKDOT\148830 - DOT&PF Parks 305-325 P\04 CADD\Prelim Eng\Alt P1\60657\_CM\_P1 P&P-1693+00.00-1723+00.00 Tue, Jul/30/19 06:13am

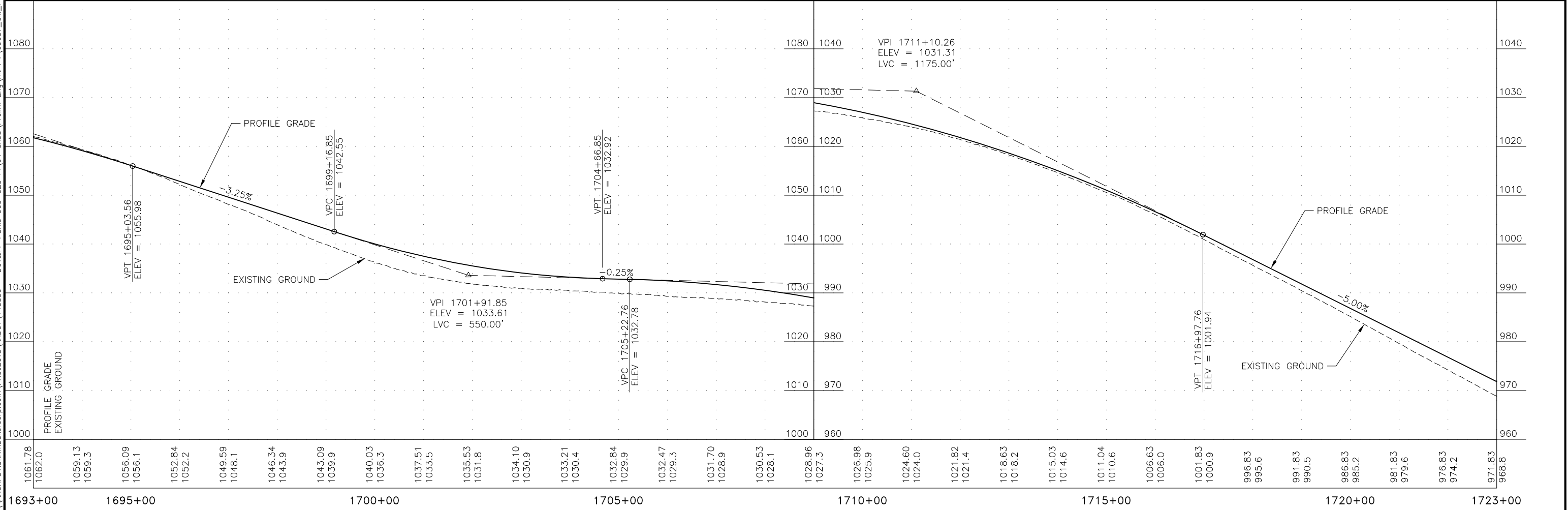

STATE	PROJECT DESIGNATION	YEAR	SHEET NO.	TOTAL SHEETS
ALASKA	0A45028/Z606570000	2020	F12	39

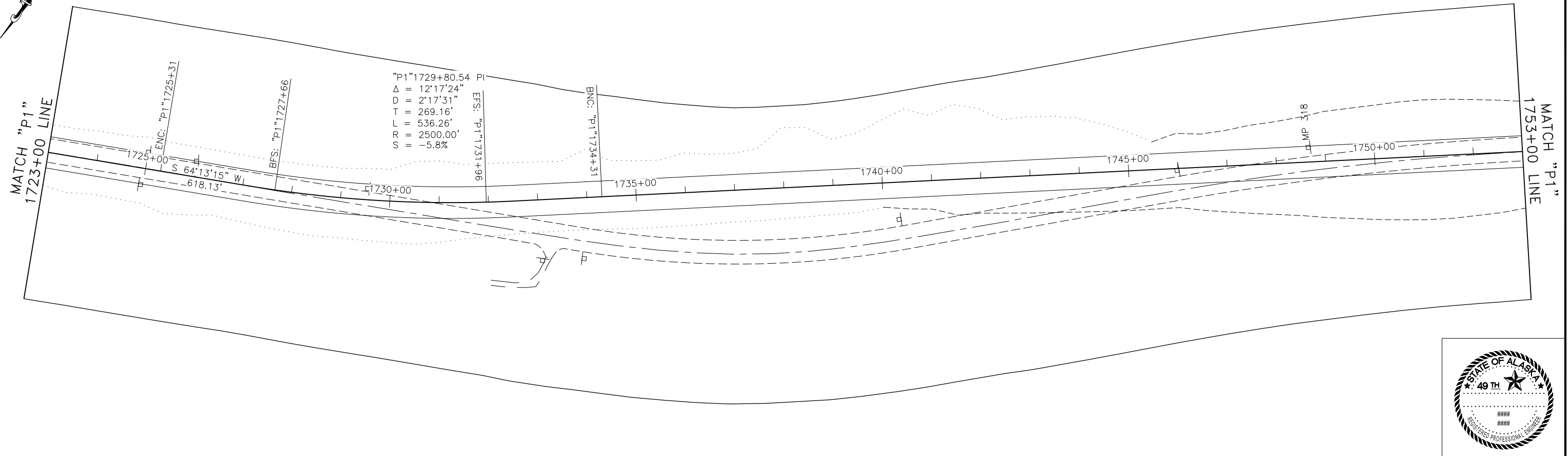
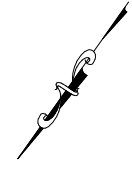

\\MANHFS1.bkr.mbakercorp.com\PROJECTS\_AKDOT\148830 - DOT&PF Parks 305-325 P\04 CADD\Prelim Eng\Alt P1\60657\_CM\_P1 P&P-1723+00.00-1753+00.00 Tue, Jul/30/19 06:14am

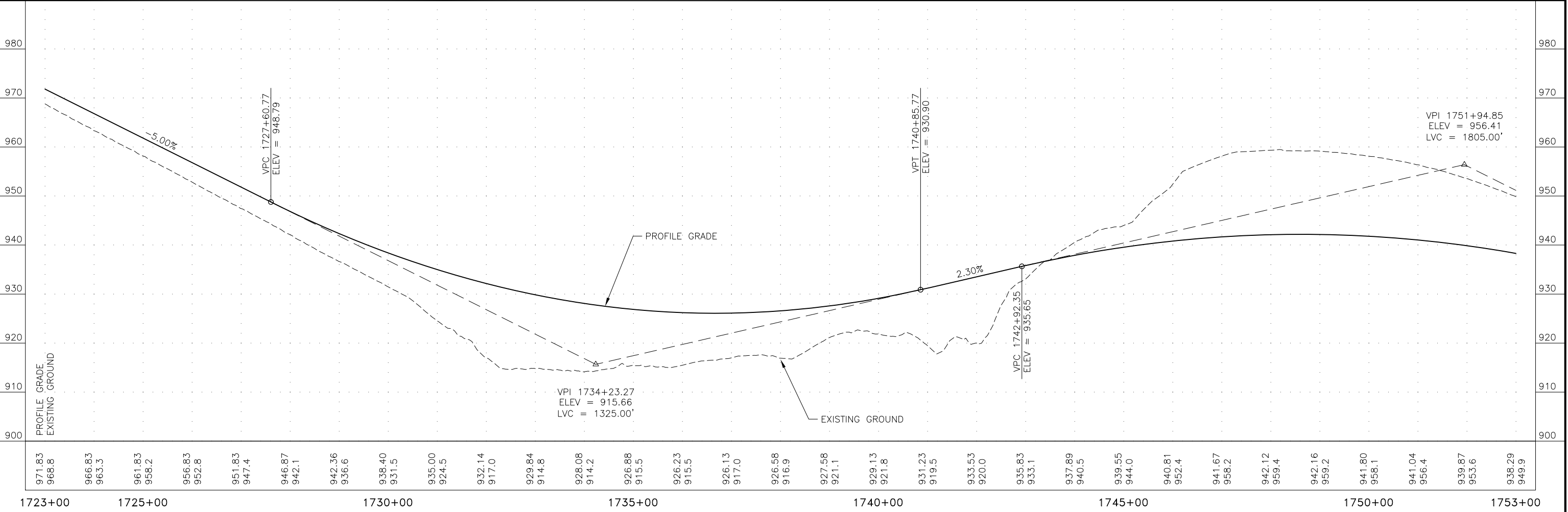



STATE	PROJECT DESIGNATION	YEAR	SHEET NO.	TOTAL SHEETS
ALASKA	0A45028/Z606570000	2020	F13	39

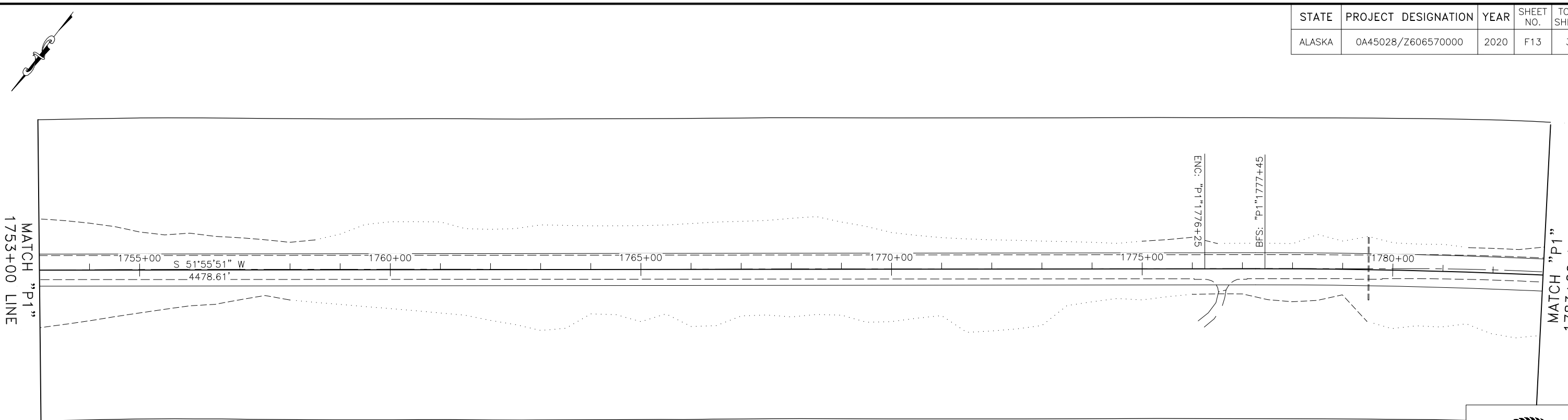

\\MANHES1.bkr.mbakercorp.com\PROJECTS\AKDOT\148830 - DOT&PF Parks 305-325 P\04 CADD\Prelim Eng\Alt P1\60657\_CM\_P1 P&P-1753+00.00-1783+00.00 Tue, Jul/30/19 06:15am

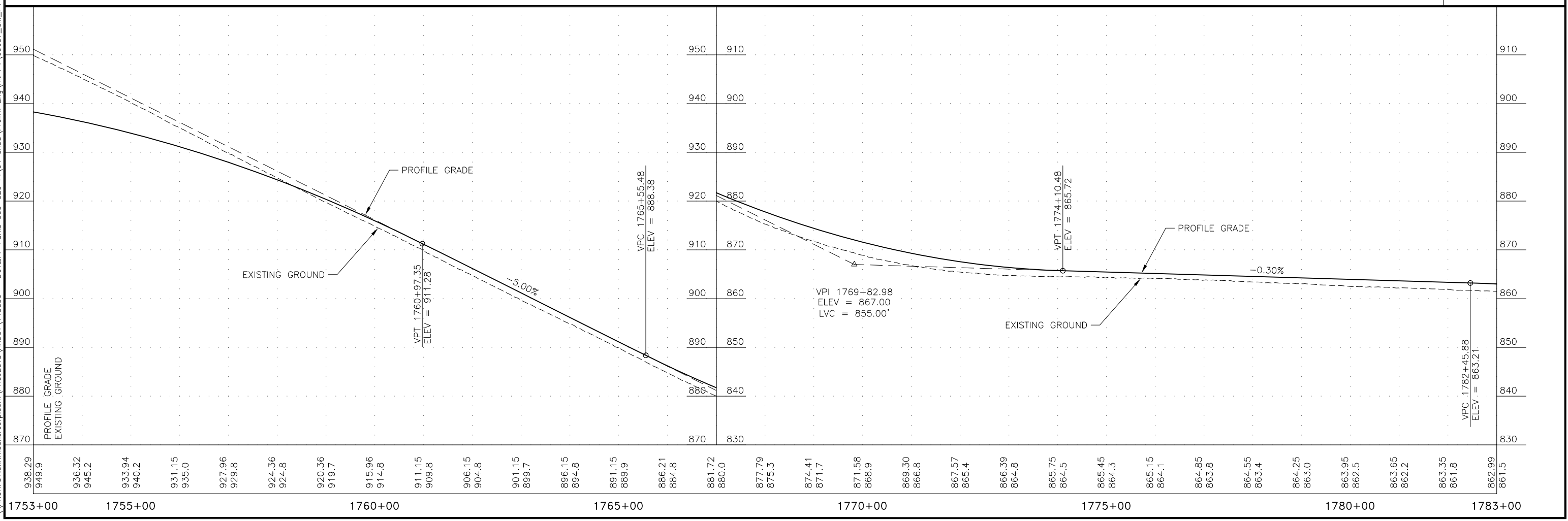

STATE	PROJECT DESIGNATION	YEAR	SHEET NO.	TOTAL SHEETS
ALASKA	0A45028/Z606570000	2020	F14	39



\\MANHFS1.bkr.mbakercorp.com\PROJECTS\AKDOT\148830 - DOT&PF Parks 305-325 P\04 CADD\Prelim Eng\Alt P1\60657\_CM\_P1 P&P-1783+00.00-1813+00.00 Tue, Jul/30/19 06:16am

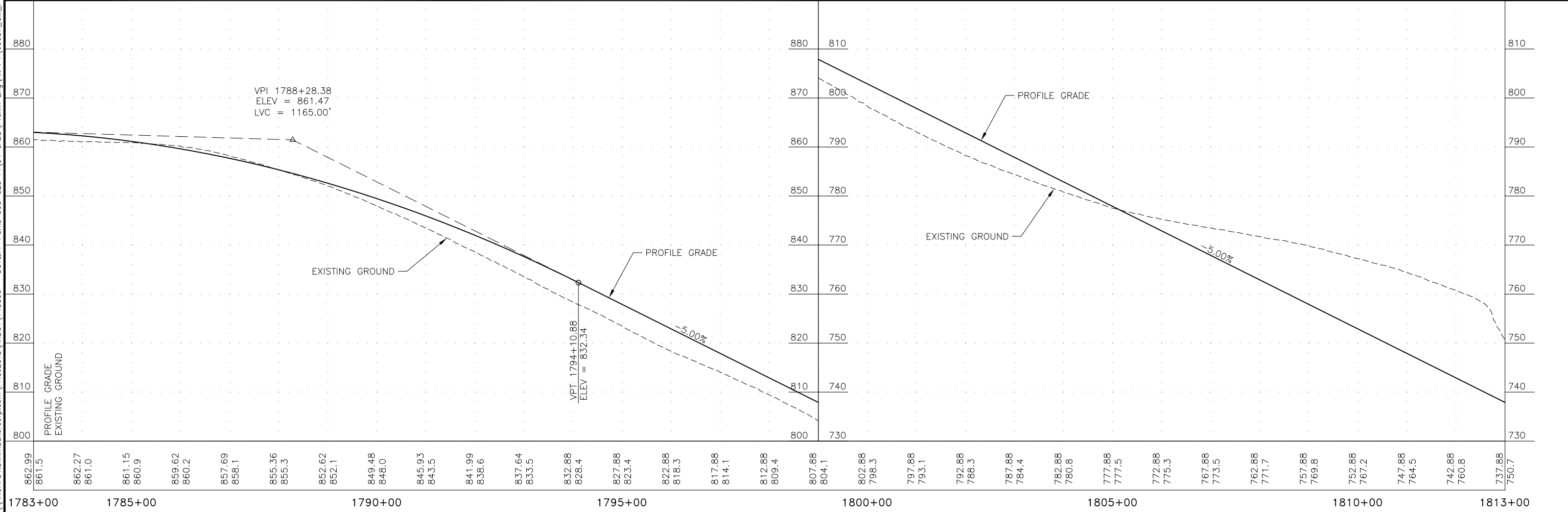

STATE	PROJECT DESIGNATION	YEAR	SHEET NO.	TOTAL SHEETS
ALASKA	0A45028/Z606570000	2020	F15	39

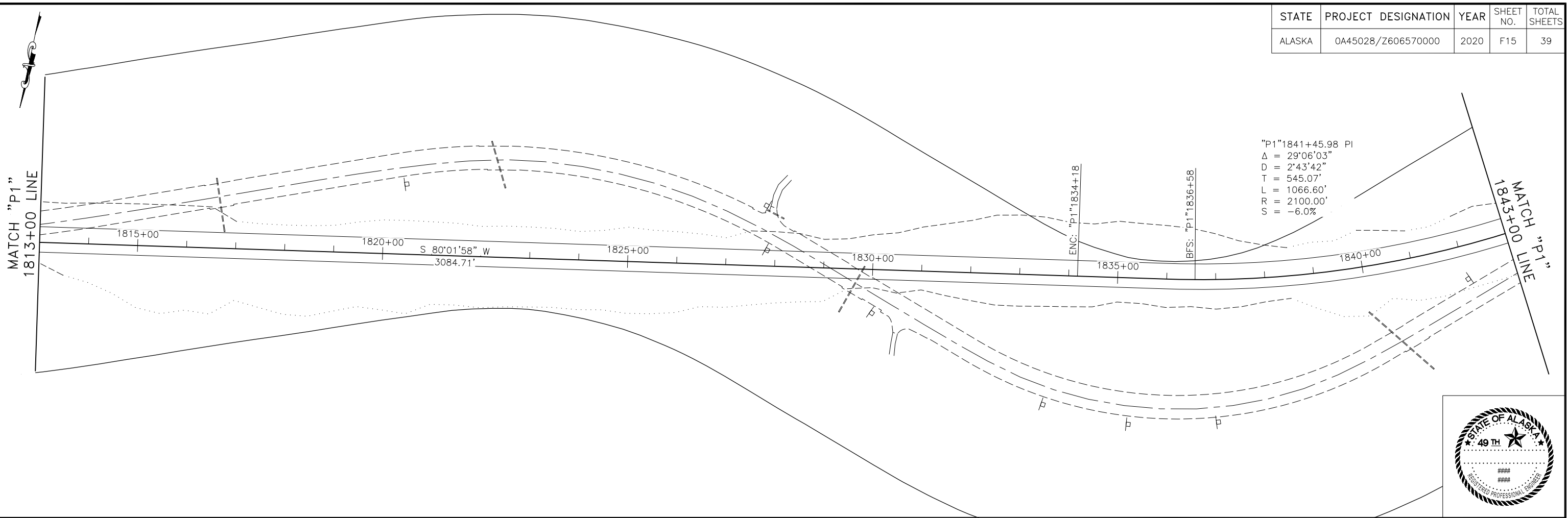

"P1" 1841+45.98 PI  
 $\Delta = 29^{\circ}06'03"$   
 $D = 2'43'42"$   
 $T = 545.07'$   
 $L = 1066.60'$   
 $R = 2100.00'$   
 $S = -6.0\%$



\\MANHES1.bkr.mbakercorp.com\PROJECTS\_AKDOT\148830 - DOT&PF Parks 305-325 P\04 CADD\Prelim Eng\Alt P1\60657\_CM\_P1 P&P-1813+00.00-1843+00.00 Tue, Jul/30/19 06:17am

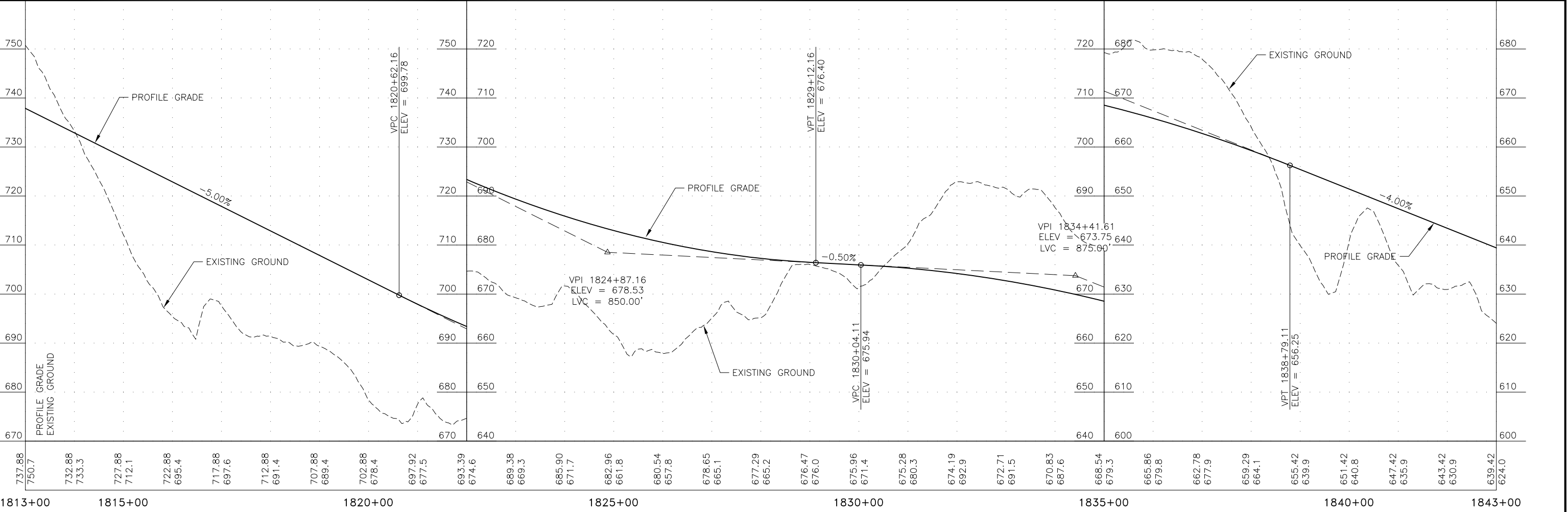

STATE	PROJECT DESIGNATION	YEAR	SHEET NO.	TOTAL SHEETS
ALASKA	0A45028/Z606570000	2020	F16	39

\\MANHFS1.bkr.mbakercorp.com\PROJECTS\_AKDOT\148830 - DOT&PF Perks 305-325 P\04 CADD\Prelim Eng\Alt P1\60657\_CM\_P1 P&P-1843+00.00-1873+00.00 Tue, Jul/30/19 06:18am

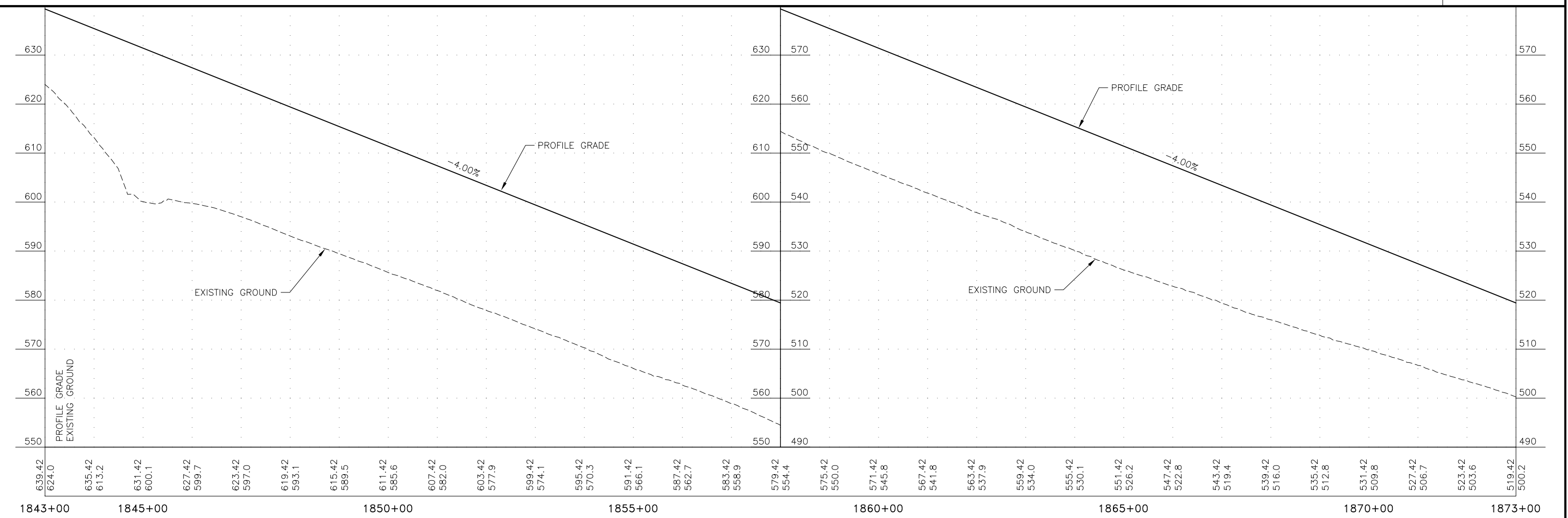
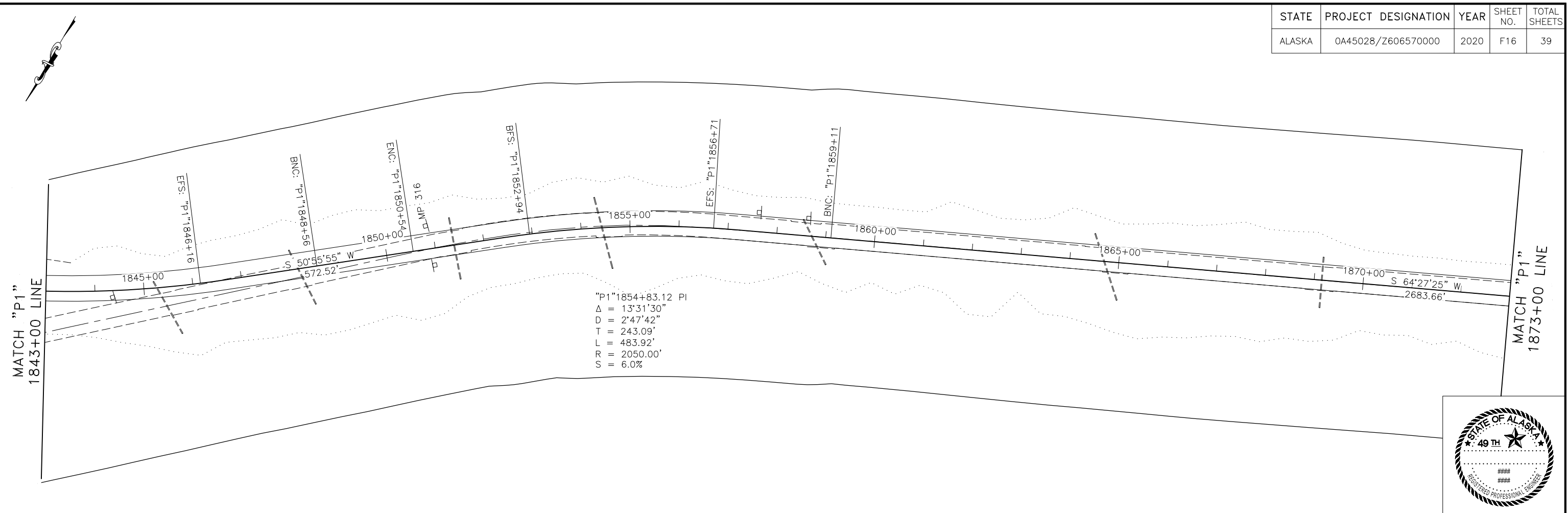

STATE	PROJECT DESIGNATION	YEAR	SHEET NO.	TOTAL SHEETS
ALASKA	0A45028/Z606570000	2020	F17	39

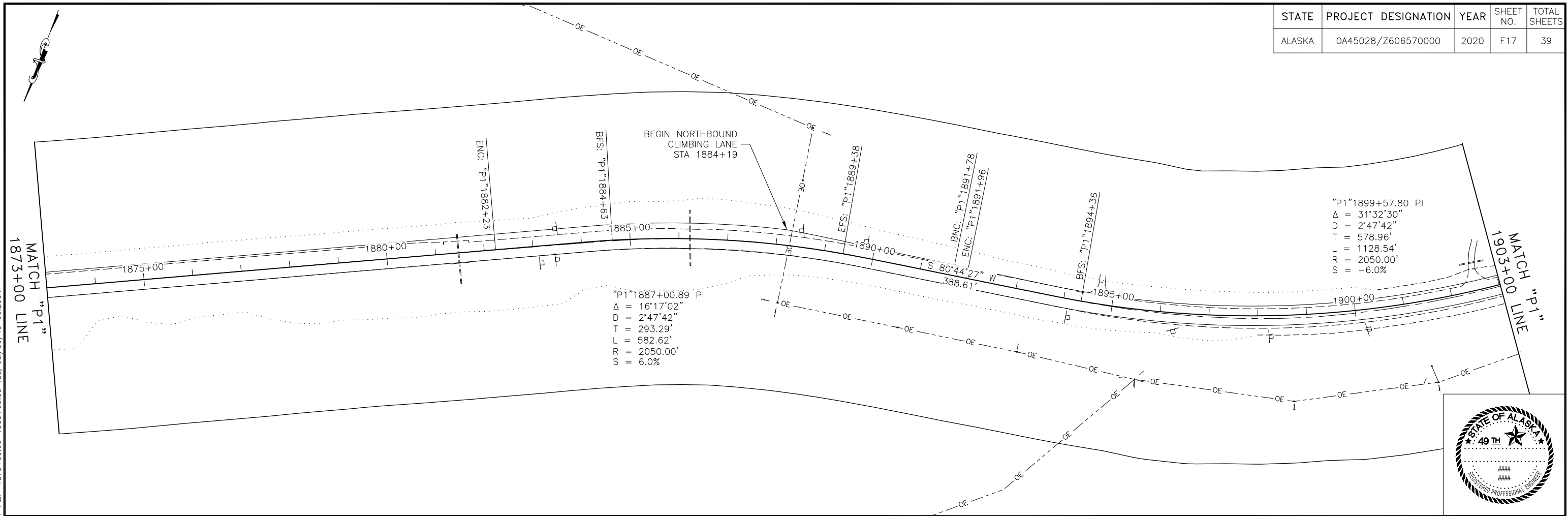

\\MANHFS1.bkr.mbakercorp.com\PROJECTS\AKDOT\148830 - DOT&PF Parks 305-325 P\04 CADD\Prelim Eng\Alt P1\60657\_CM\_P1 P&P-1873+00.00-1903+00.00 Tue, Jul/30/19 06:20am

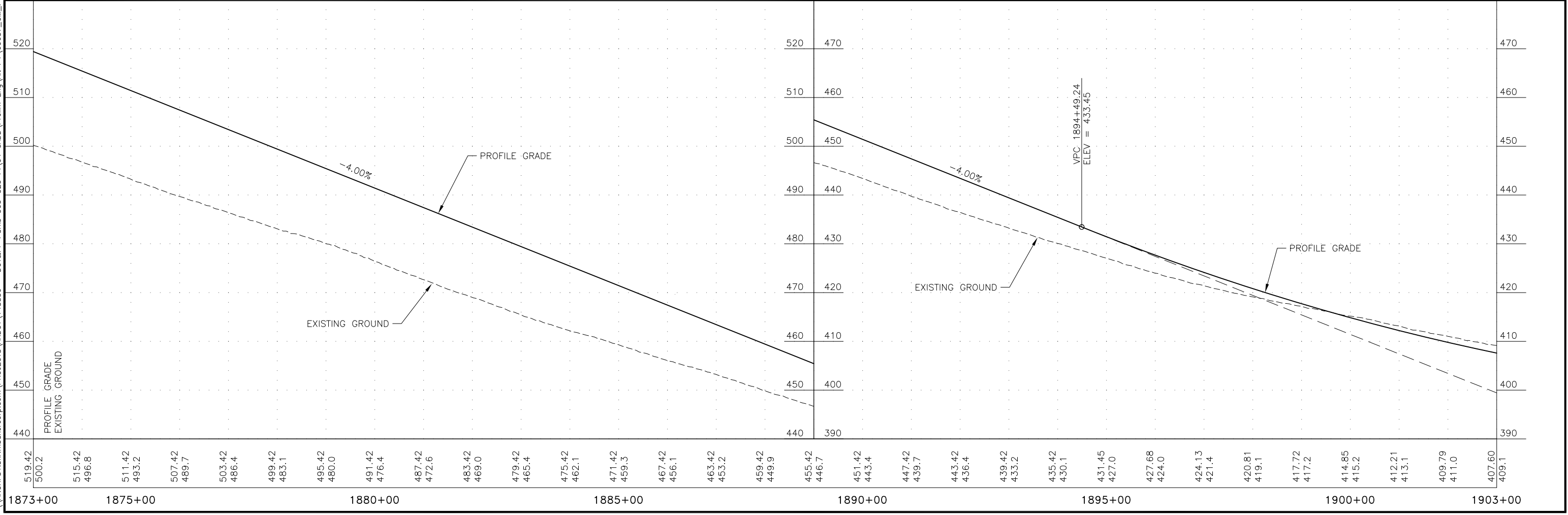



STATE	PROJECT DESIGNATION	YEAR	SHEET NO.	TOTAL SHEETS
ALASKA	0A45028/Z606570000	2020	F18	39

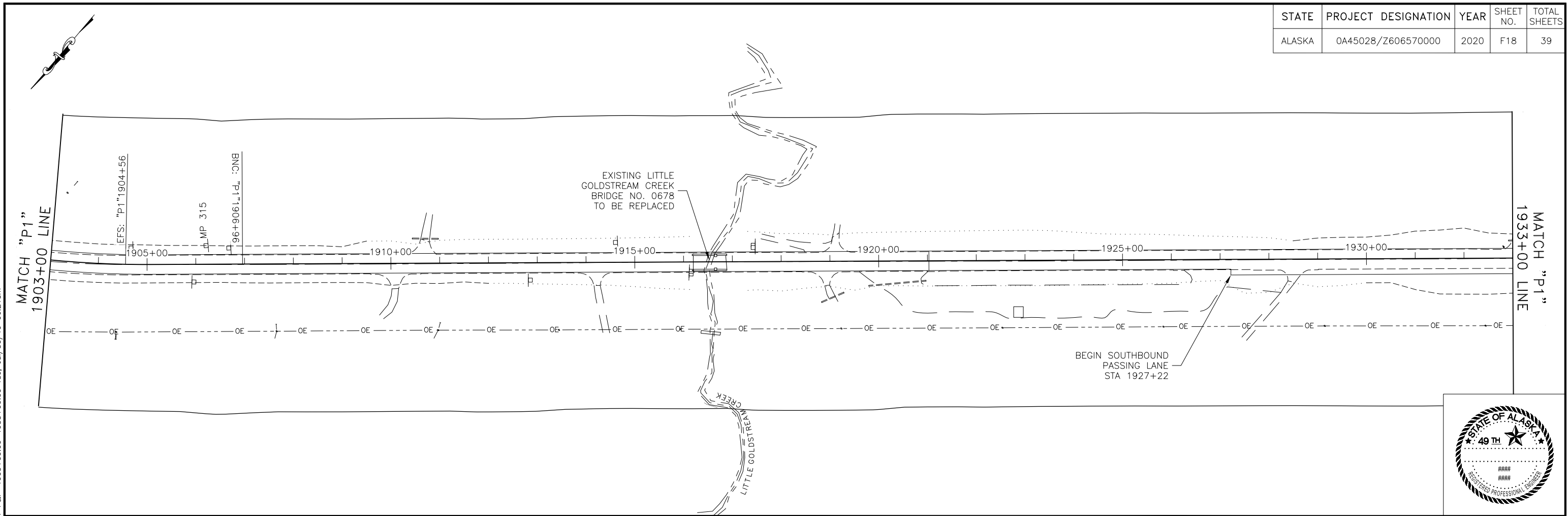

\\MANHFS1.bkr.mbakercorp.com\PROJECTS\AKDOT\148830 - DOT&PF Parks 305-325 P\04 CADD\Prelim Eng\Alt P1\60657\_CM\_P1 P&P-1903+00.00-1933+00.00 Tue, Jul/30/19 06:21am

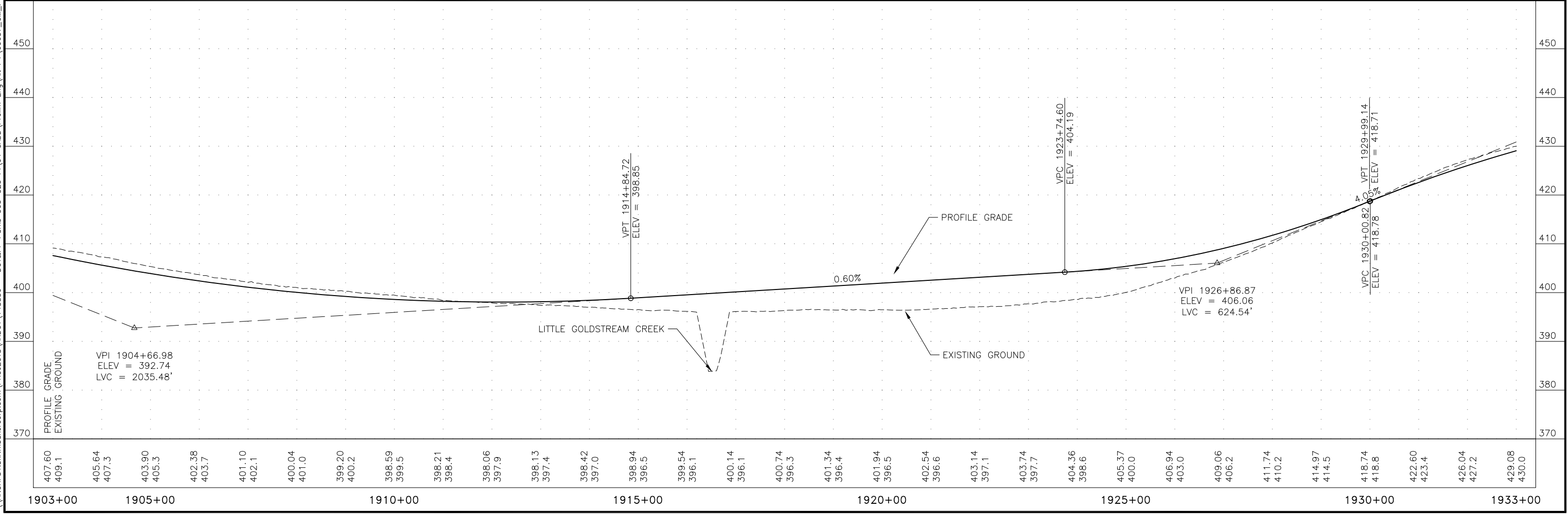

STATE	PROJECT DESIGNATION	YEAR	SHEET NO.	TOTAL SHEETS
ALASKA	0A45028/Z606570000	2020	F19	39

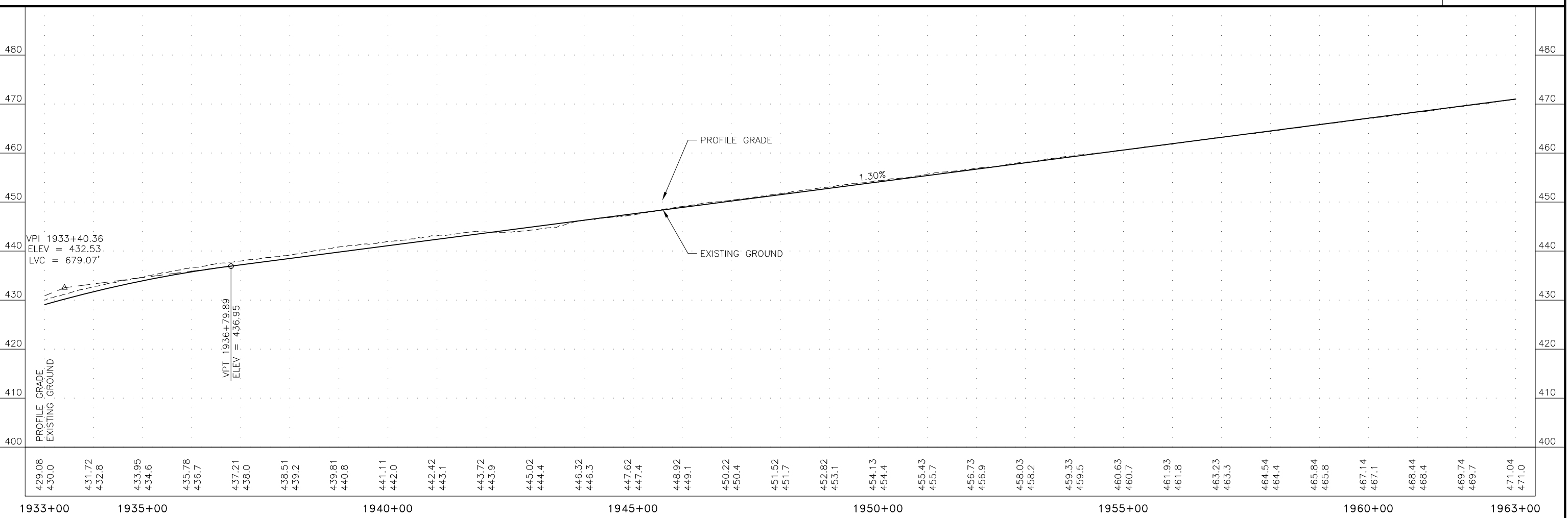
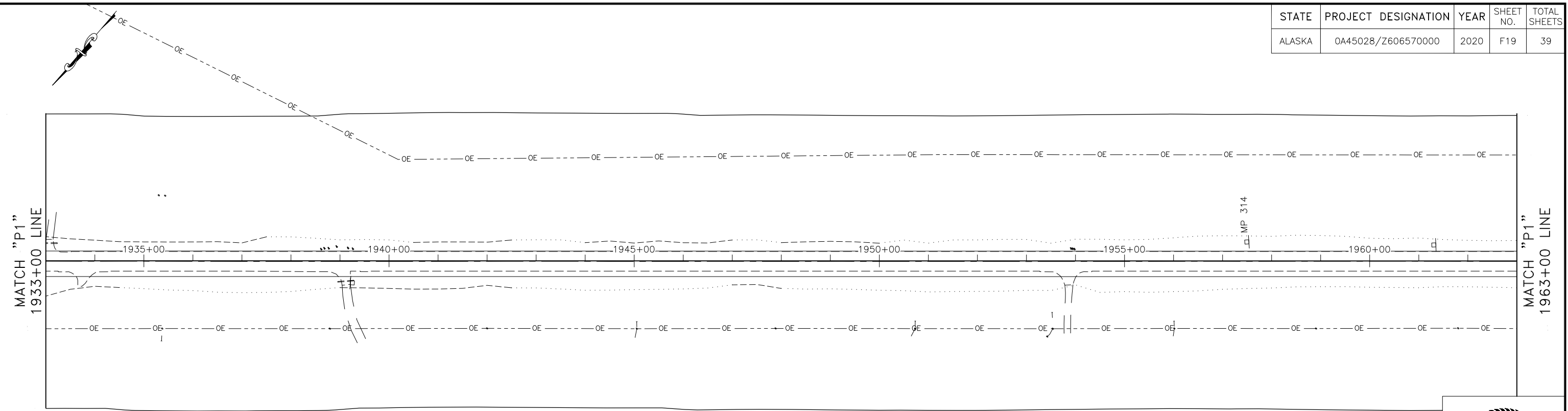

\\ANCHFS1.bkr.mbakercorp.com\PROJECTS\AKDOT\148830 - DOT&PF Parks 305-325 P\04 CADD\Prelim Eng\Alt P1\60657\_CM\_P1 P&P-1933+00.00-1963+00.00 Tue, Jul/30/19 06:22am

STATE	PROJECT DESIGNATION	YEAR	SHEET NO.	TOTAL SHEETS
ALASKA	0A45028/Z606570000	2020	F20	39

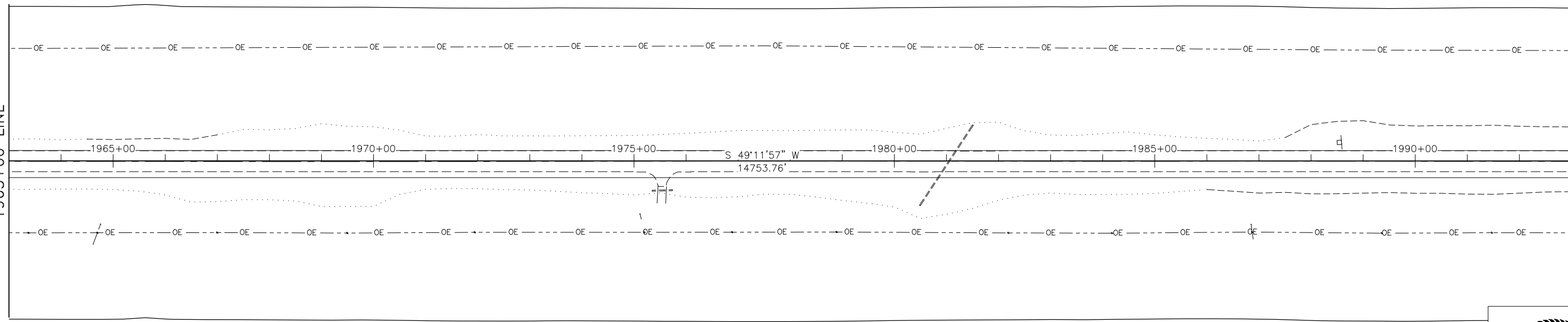

\\MANHES1.bkr.mbakercorp.com\PROJECTS\AKDOT\148830 - DOT&PF Parks 305-325 P\04 CADD\Prelim Eng\Alt P1\60657\_CM\_P1 P&P-1963+00.00-1993+00.00 Tue, Jul/30/19 06:23am

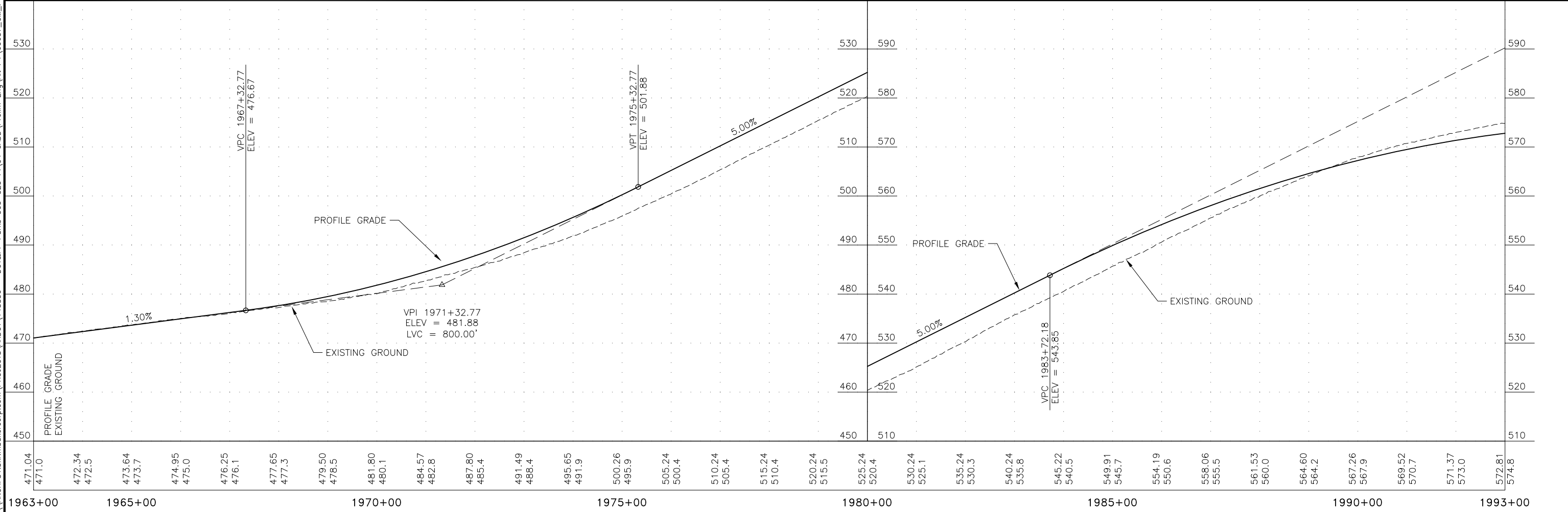

STATE	PROJECT DESIGNATION	YEAR	SHEET NO.	TOTAL SHEETS
ALASKA	0A45028/Z606570000	2020	F21	39

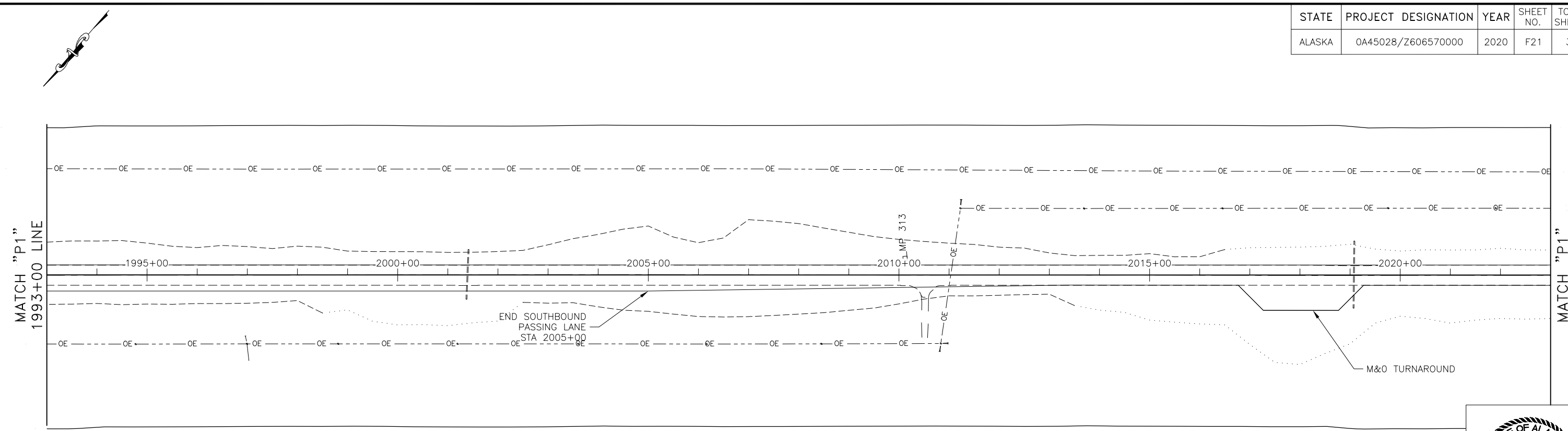

\\ANCHFS1.bkr.mbakercorp.com\PROJECTS\_AKDOT\148830 - DOT&PF Parks 305-325 P\04 CADD\Prelim Eng\Alt P1\60657\_CM\_P1 P&P-1993+00.00-2023+00.00 Tue, Jul/30/19 06:25am

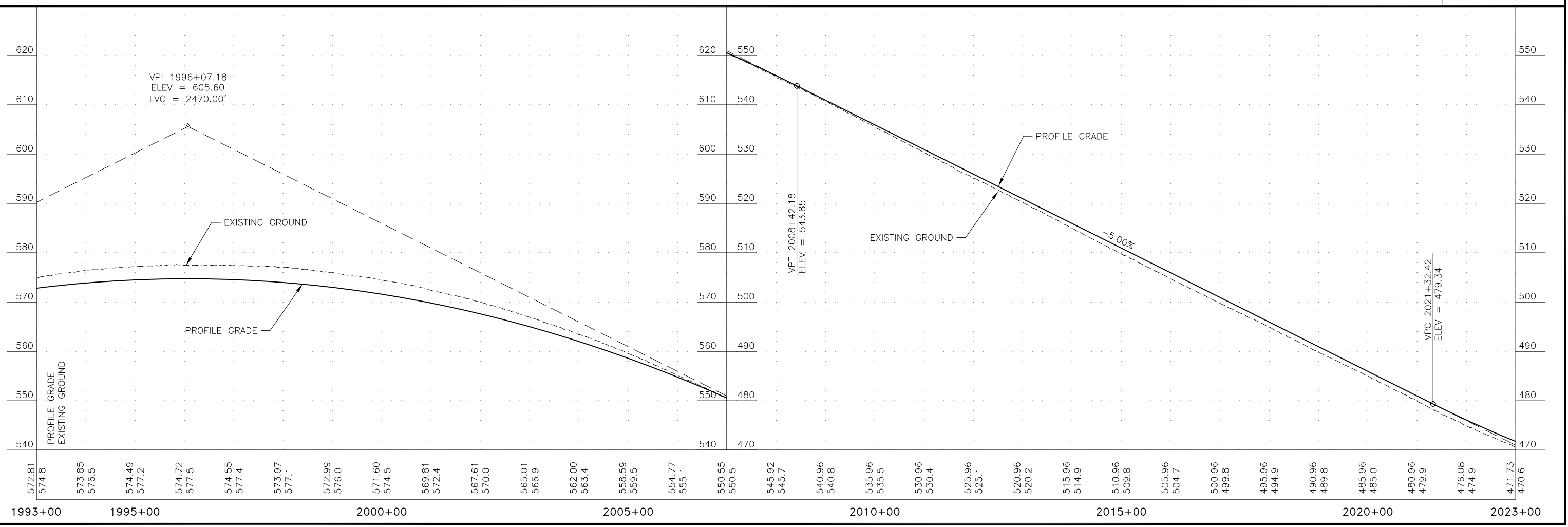

STATE	PROJECT DESIGNATION	YEAR	SHEET NO.	TOTAL SHEETS
ALASKA	0A45028/Z606570000	2020	F22	39

\\MANHFS1.bkr.mbakercorp.com\PROJECTS\AKDOT\148830 - DOT&PF Parks 305-325 P\04 CADD\Prelim Eng\Alt P1\60657\_CM\_P1 P&P-2023+00.00-2053+00.00 Tue, Jul/30/19 06:26am

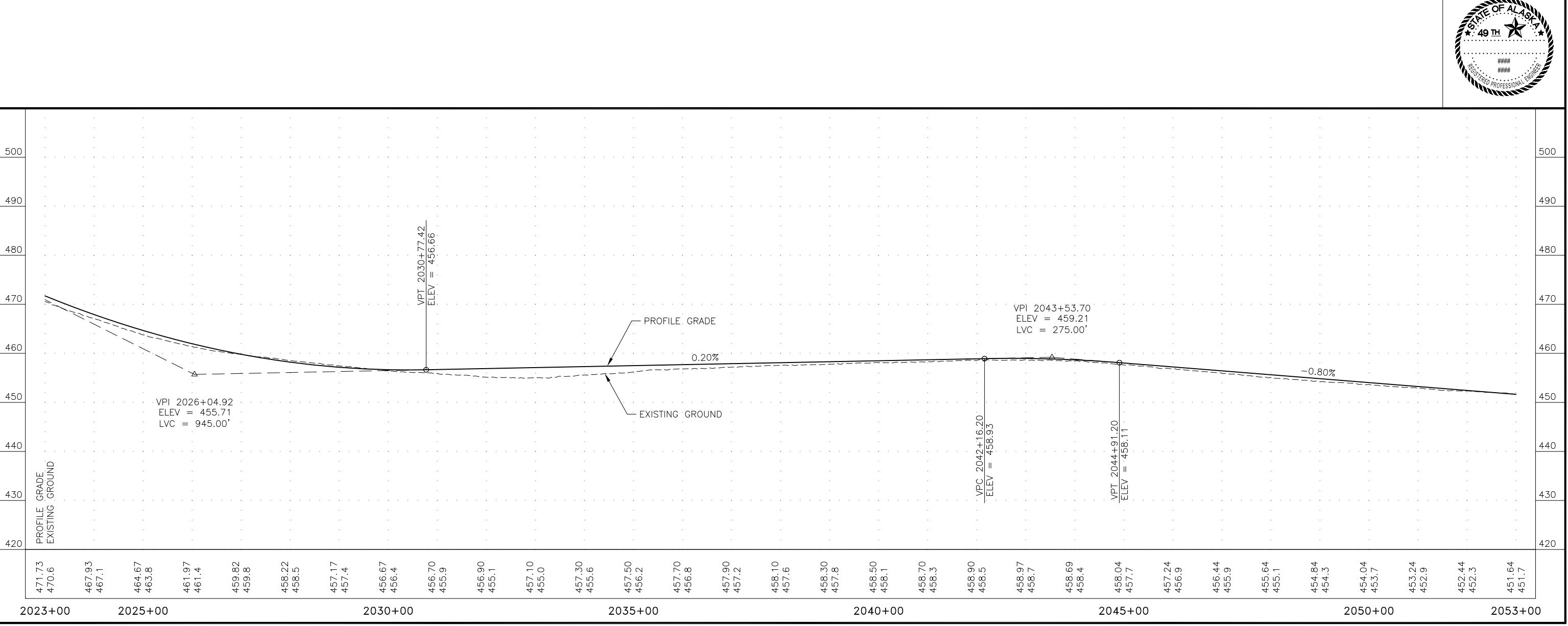
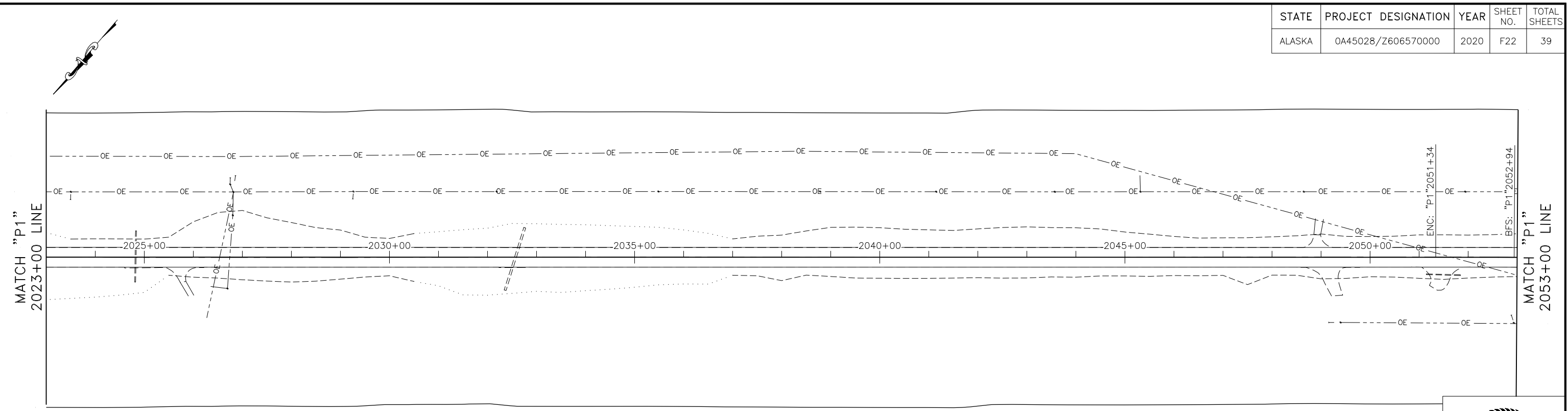



STATE	PROJECT DESIGNATION	YEAR	SHEET NO.	TOTAL SHEETS
ALASKA	0A45028/Z606570000	2020	F23	39

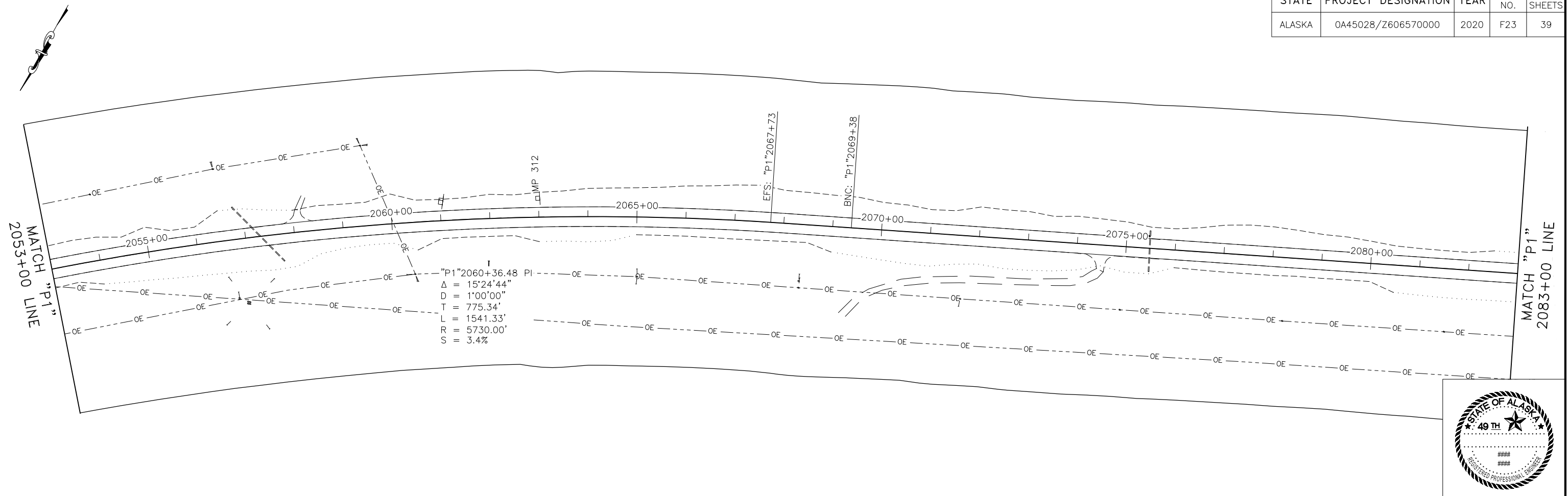

\\MANHFS1.bkr.mbakercorp.com\PROJECTS\_AKDOT\148830 - DOT&PF Parks 305-325 P\04 CADD\Prelim Eng\Alt P1\60657\_CM\_P1 P&P-2053+00.00-2083+00.00 Tue, Jul/30/19 06:28am

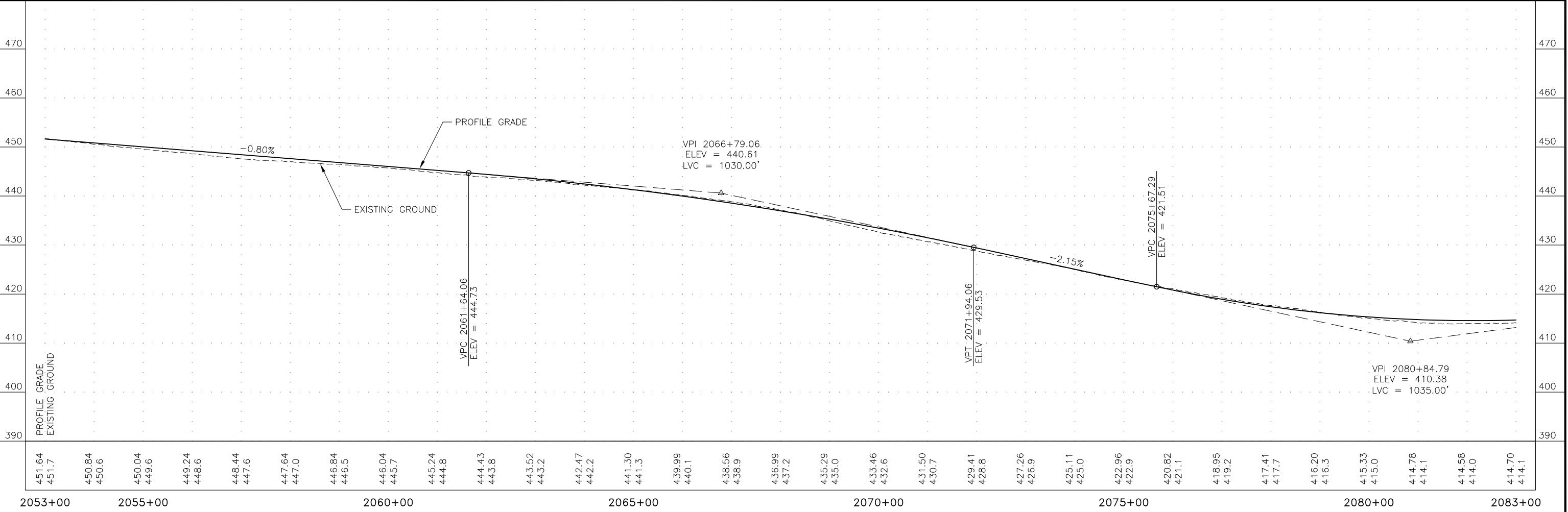

STATE	PROJECT DESIGNATION	YEAR	SHEET NO.	TOTAL SHEETS
ALASKA	0A45028/Z606570000	2020	F24	39

\\MANHFS1.bkr.mbakercorp.com\PROJECTS\AKDOT\148830 - DOT&PF Parks 305-325 P\04 CADD\Prelim Eng\Alt P1\60657\_CM\_P1 P&P-2083+00.00-2113+00.00 Tue, Jul/30/19 06:29am

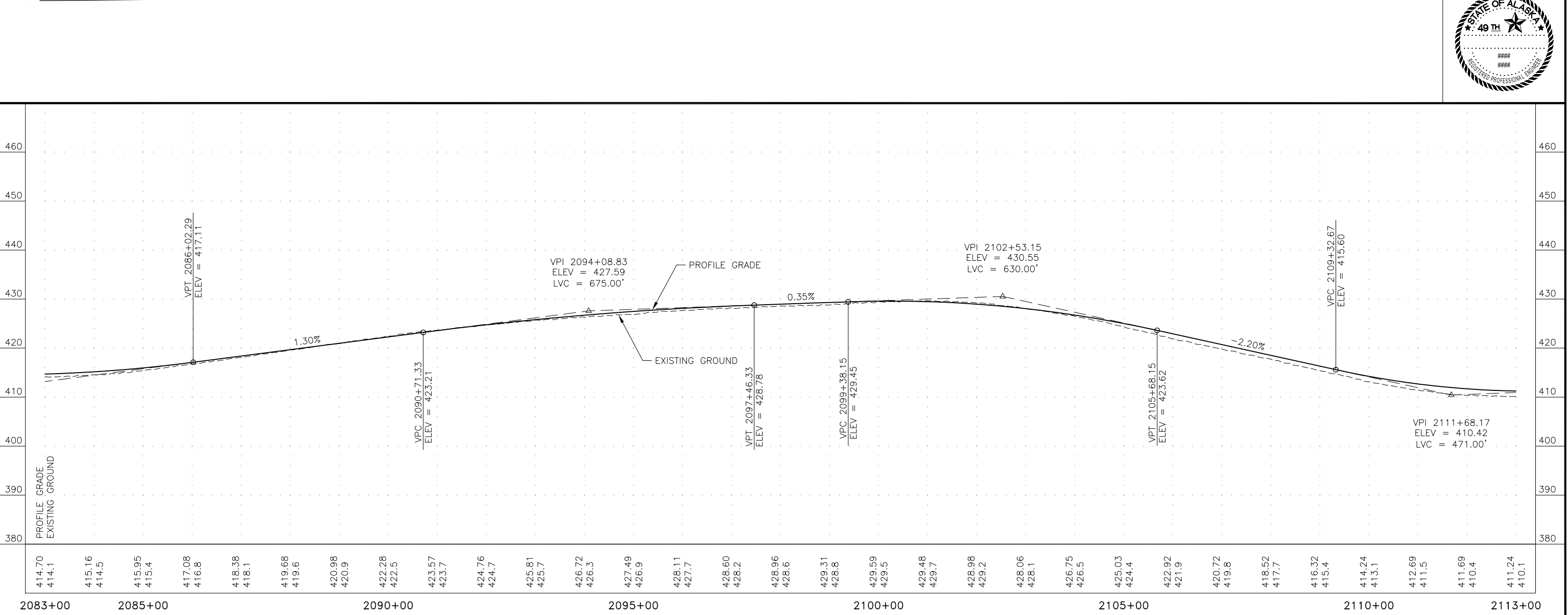
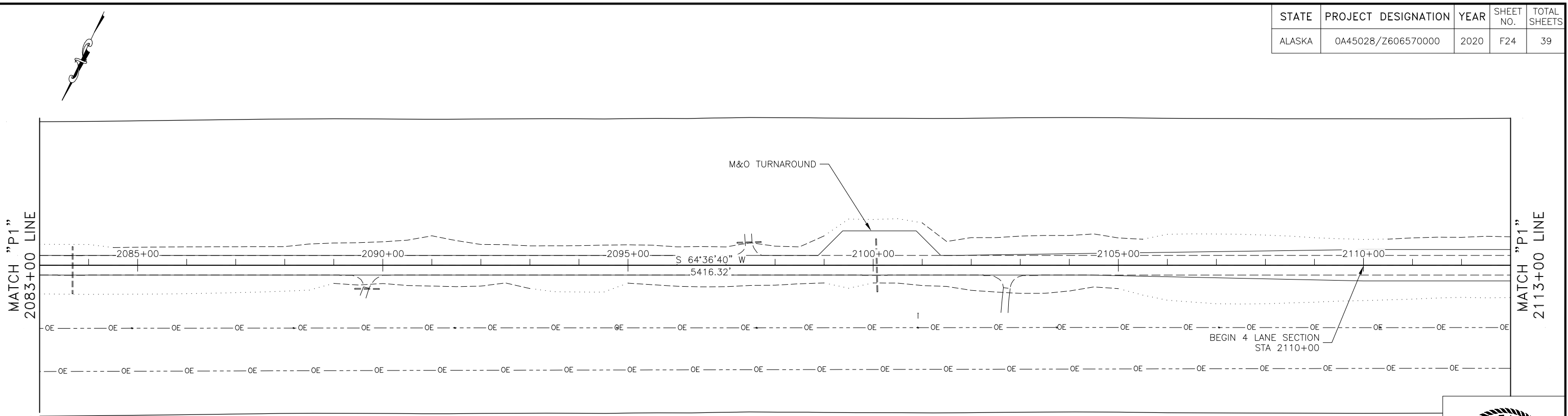

STATE	PROJECT DESIGNATION	YEAR	SHEET NO.	TOTAL SHEETS
ALASKA	0A45028/Z606570000	2020	F25	39

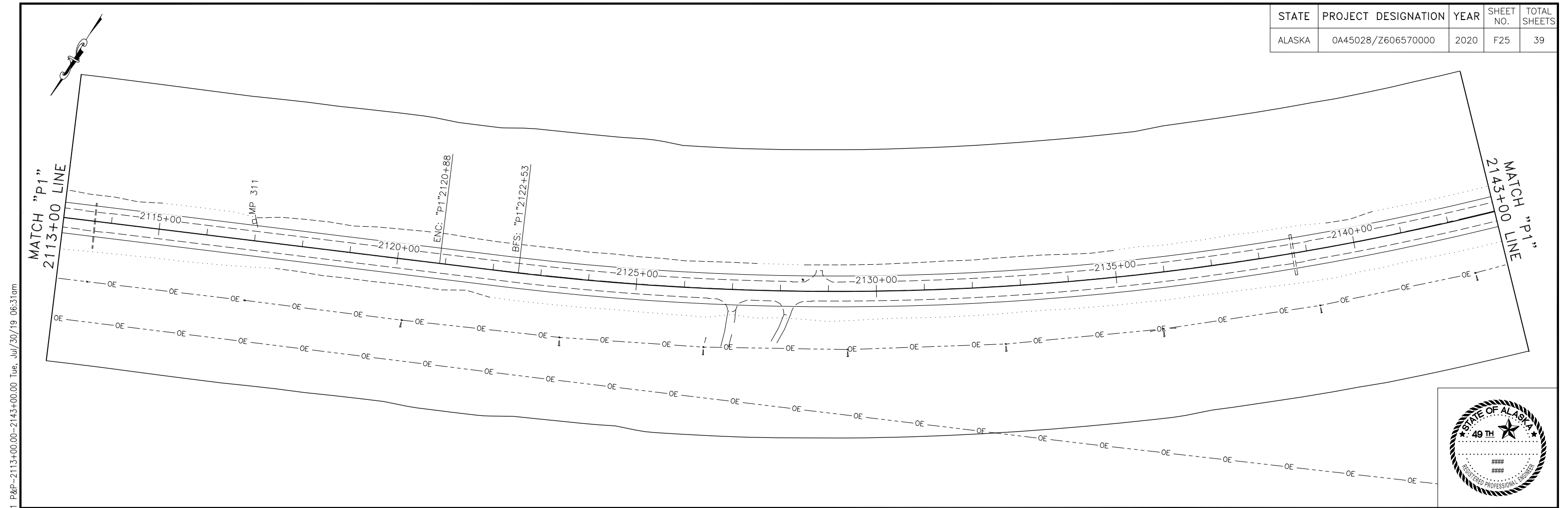

\\MANHFS1.bkr.mbakercorp.com\PROJECTS\_AKDOT\148830 - DOT&PF Parks 305-325 P\04 CADD\Prelim Eng\Alt P1\60657\_CM\_P1 P&P-2113+00.00-2143+00.00 Tue, Jul/30/19 06:31am

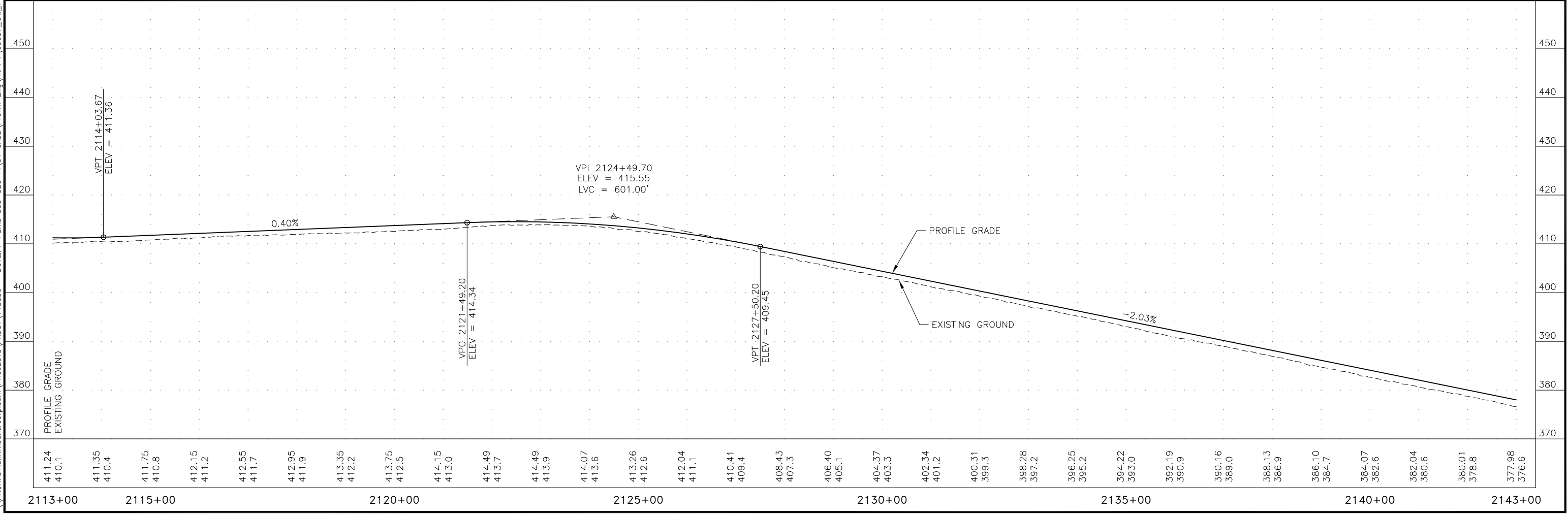

STATE	PROJECT DESIGNATION	YEAR	SHEET NO.	TOTAL SHEETS
ALASKA	0A45028/Z606570000	2020	F26	39

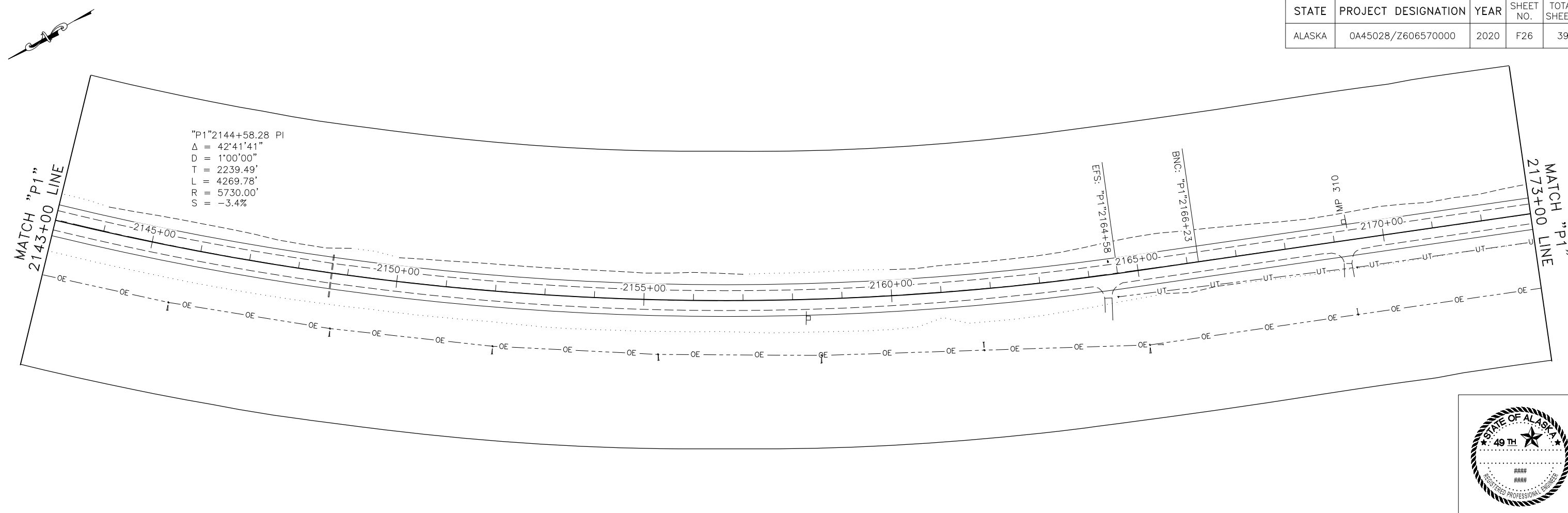

\\MANHFS1.bkr.mbakercorp.com\PROJECTS\_AKDOT\148830 - DOT&PF Parks 305-325 P\04 CADD\Prelim Eng\Alt P1\60657\_CM\_P1 P&P-2143+00.00-2173+00.00 Tue, Jul/30/19 06:32am

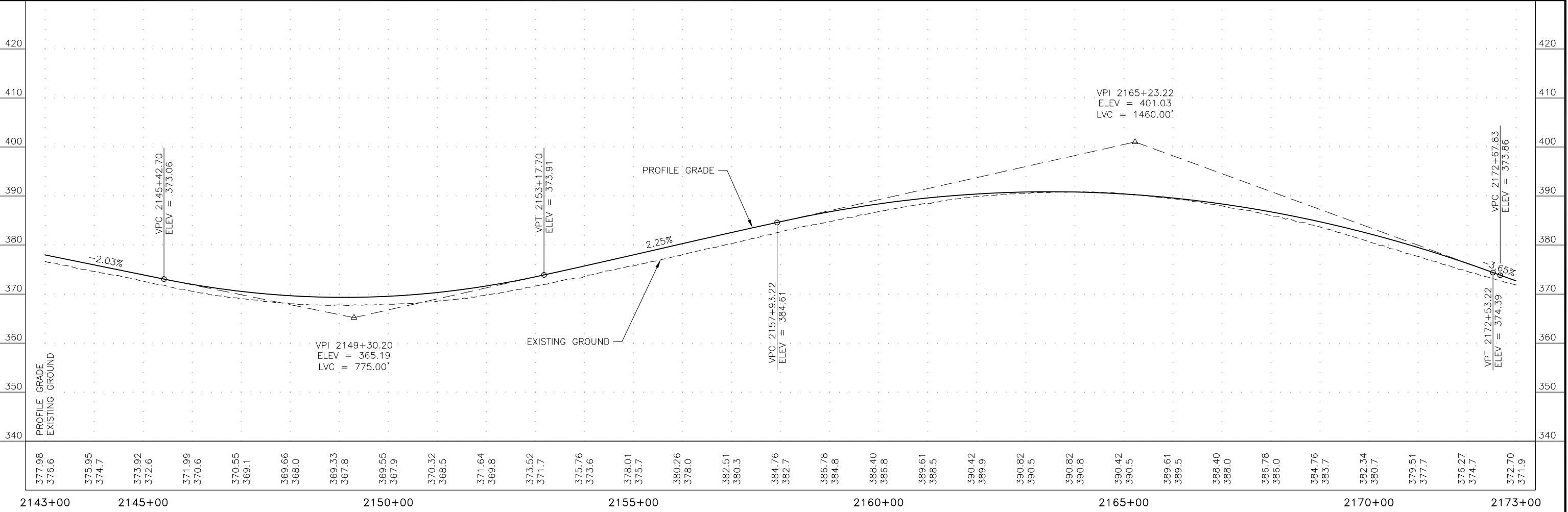

STATE	PROJECT DESIGNATION	YEAR	SHEET NO.	TOTAL SHEETS
ALASKA	0A45028/Z606570000	2020	F27	39

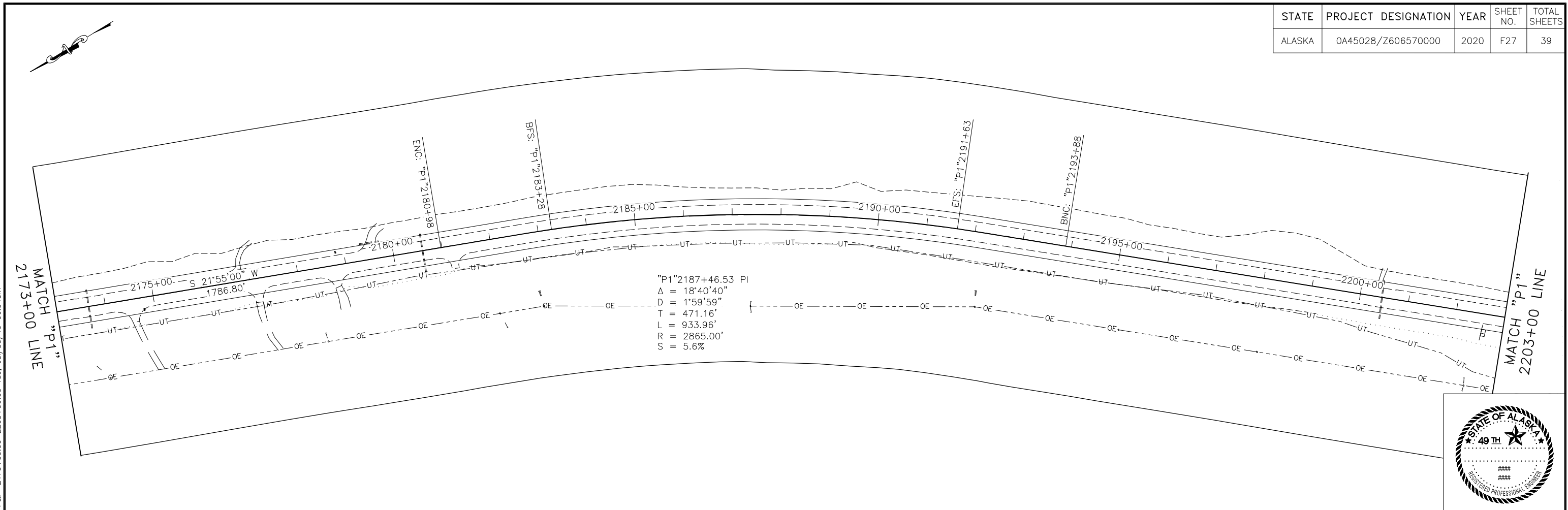

\\MANHFS1.bkr.mbakercorp.com\PROJECTS\_AKDOT\148830 - DOT&PF Parks 305-325 P\04 CADD\Prelim Eng\Alt P1\60657\_CM\_P1 P&P-2173+00-2203+00.00 Tue, Jul/30/19 06:34am

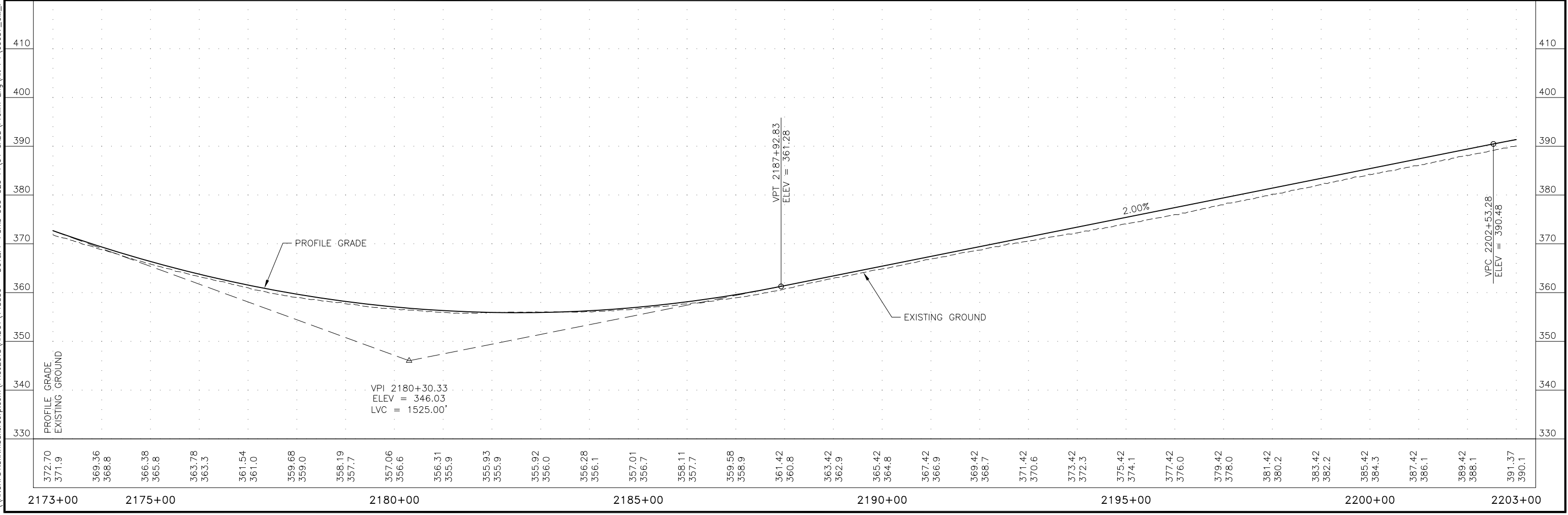



STATE	PROJECT DESIGNATION	YEAR	SHEET NO.	TOTAL SHEETS
ALASKA	0A45028/Z606570000	2020	F28	39

\\MANHFS1.bkr.mbakercorp.com\PROJECTS\AKDOT\148830 - DOT&PF Parks 305-325 P\04 CADD\Prelim Eng\Alt P1\60657\_CM\_P1 P&P-2203+00.00-2233+00.00 Tue, Jul/30/19 06:36am

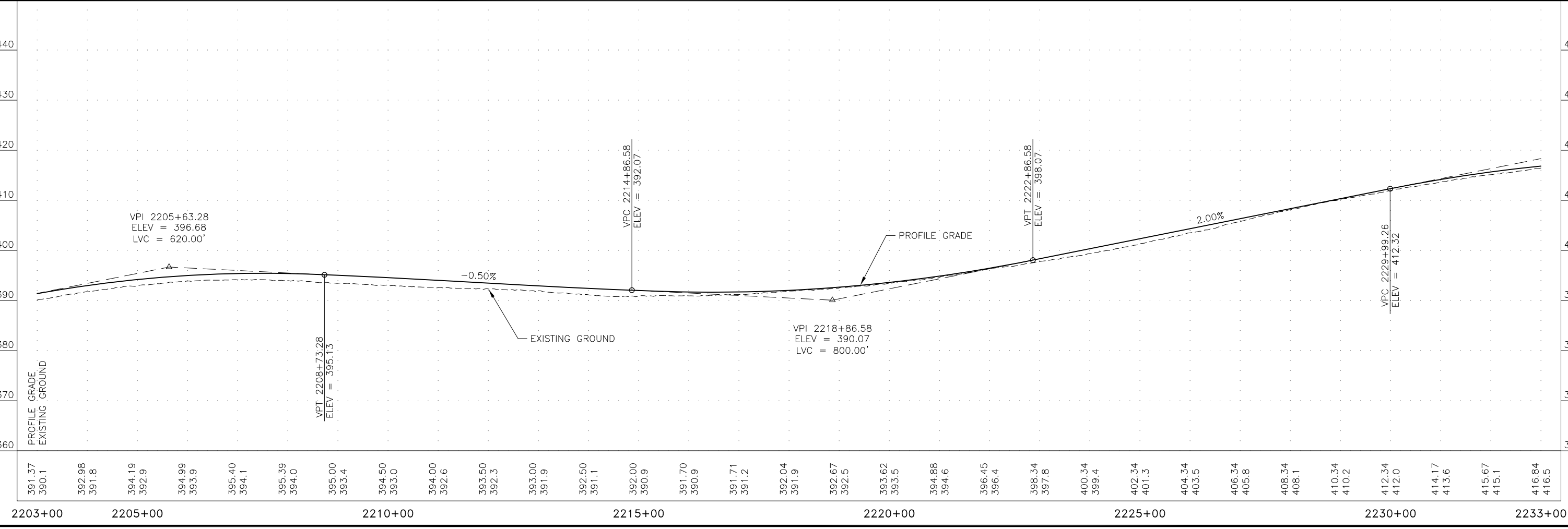
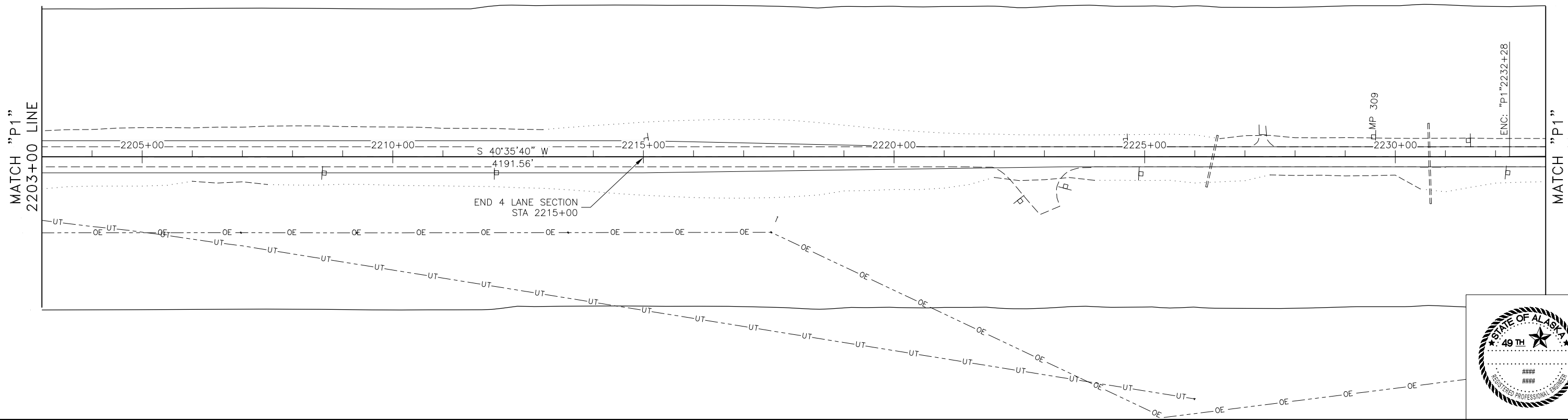

STATE	PROJECT DESIGNATION	YEAR	SHEET NO.	TOTAL SHEETS
ALASKA	0A45028/Z606570000	2020	F29	39

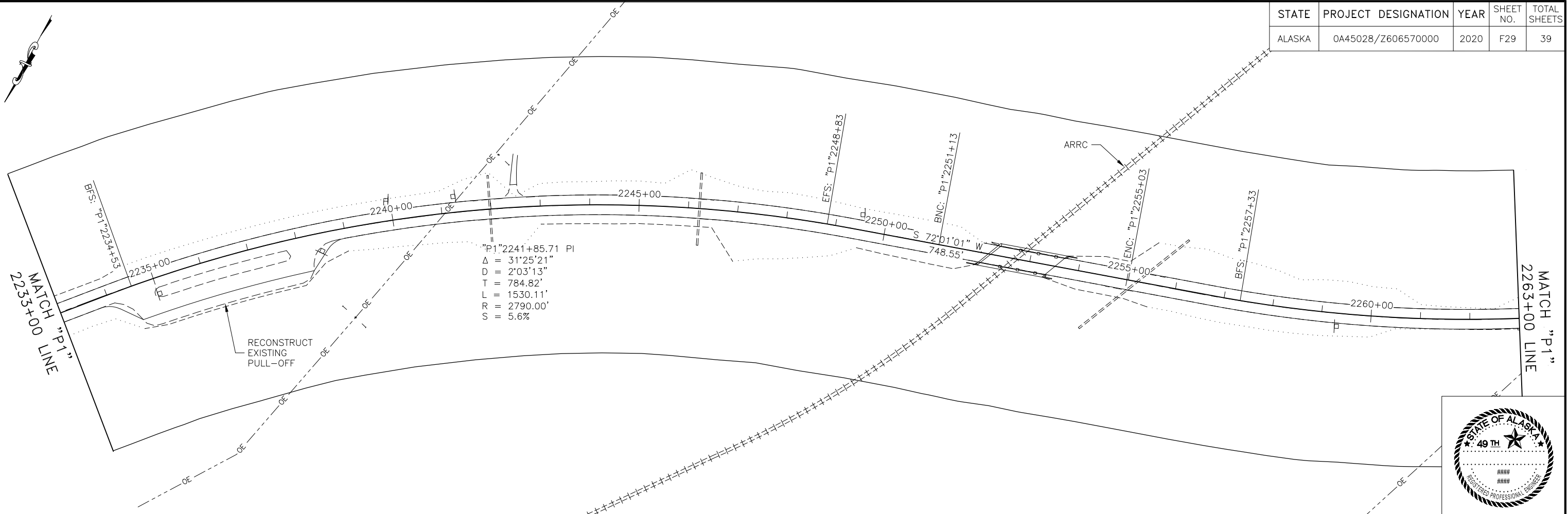

\\MANHFS1.bkr.mbakercorp.com\PROJECTS\AKDOT\148830 - DOT&PF Parks 305-325 P\04 CADD\Prelim Eng\Alt P1\60657\_CM\_P1 P&P-2233+00.00-2263+00.00 Tue, Jul/30/19 06:37am

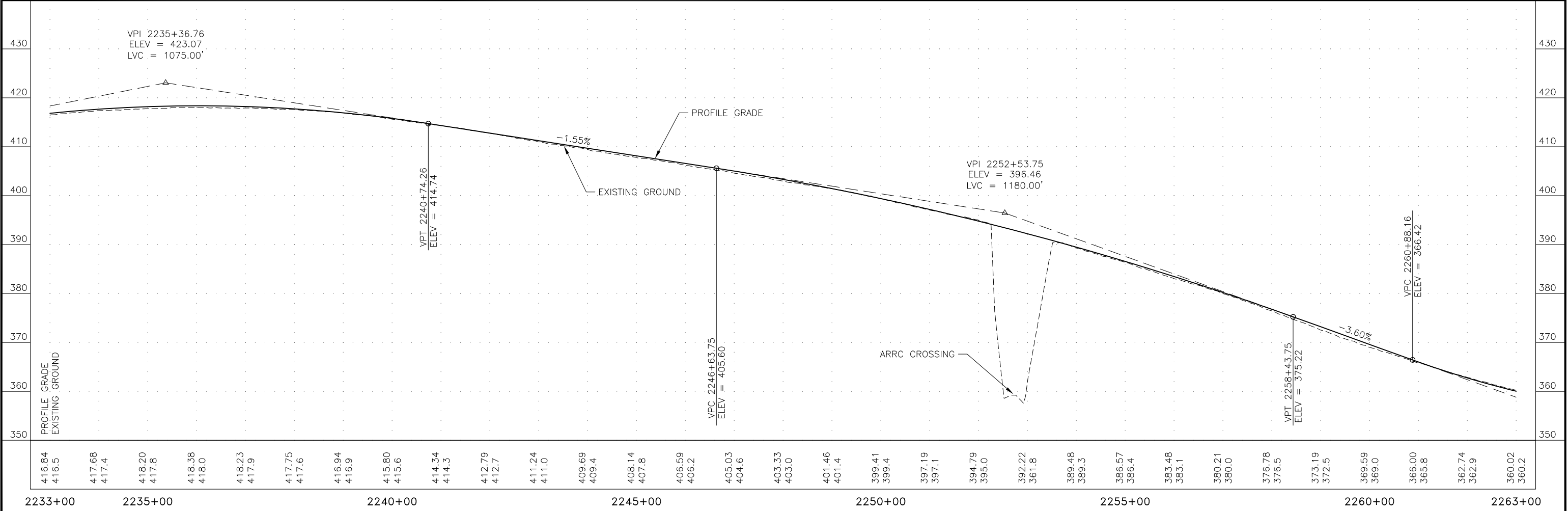

STATE	PROJECT DESIGNATION	YEAR	SHEET NO.	TOTAL SHEETS
ALASKA	0A45028/Z606570000	2020	F30	39

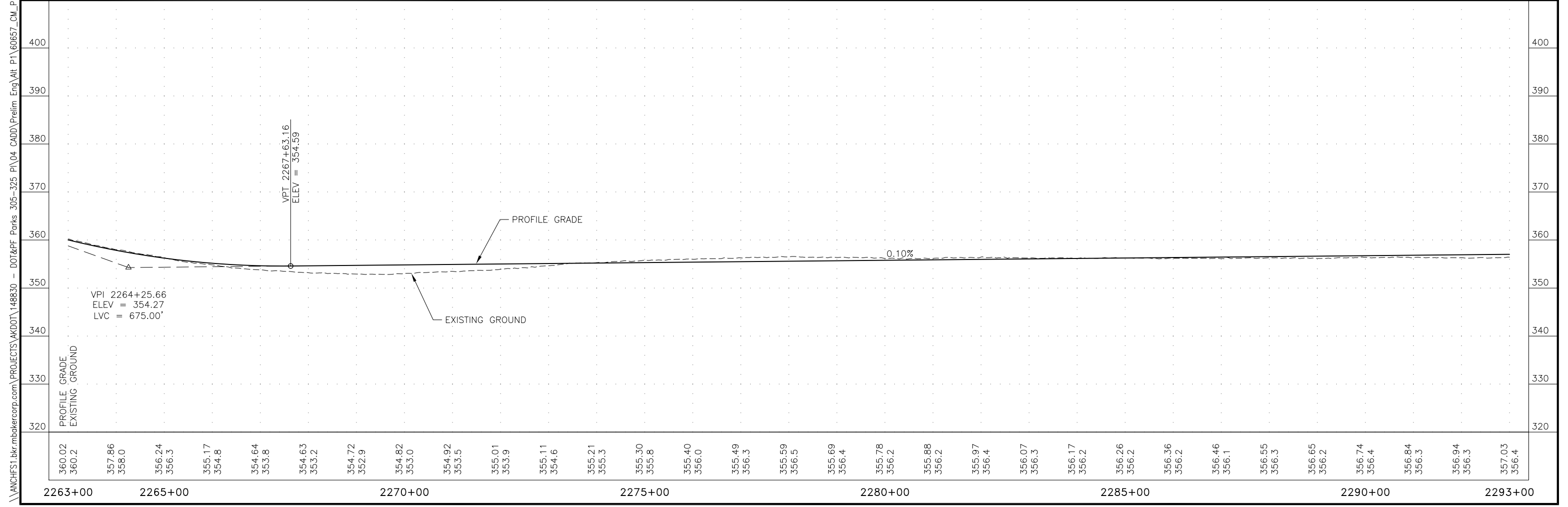
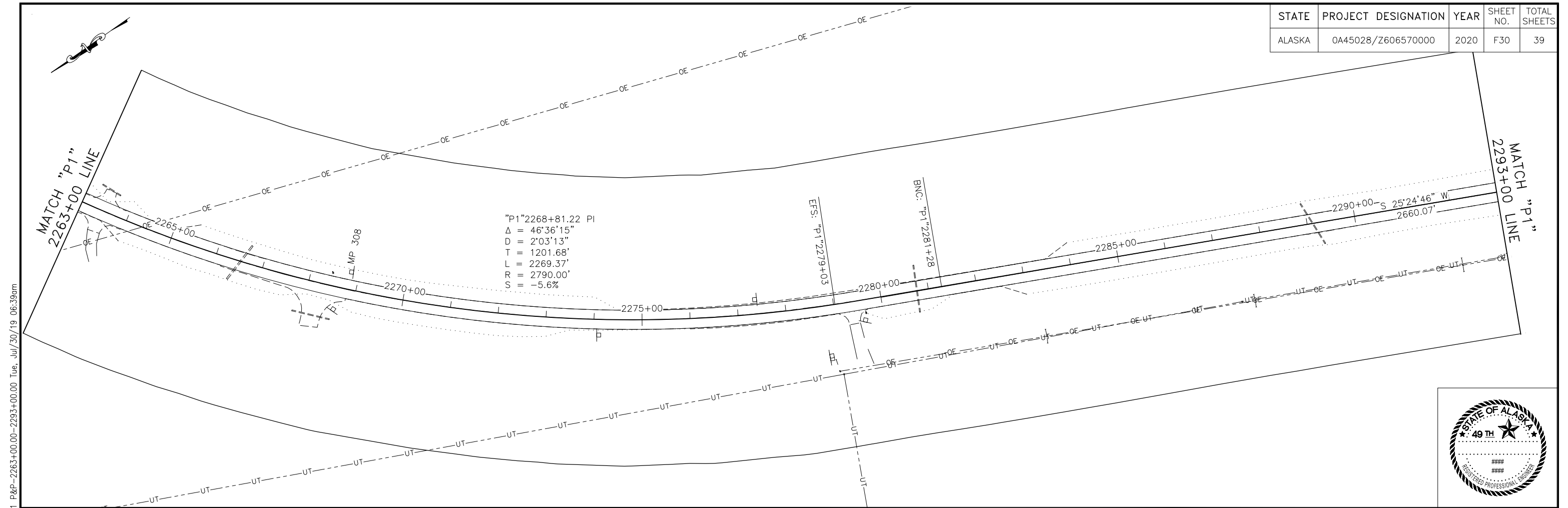

\\MANCHFS1.bkr.mbakercorp.com\PROJECTS\AKDOT\148830 - DOT&PF Parks 305-325 P\04 CADD\Prelim Eng\Alt P1\60657\_CM\_P1 P&P-2263+00.00-2293+00.00 Tue, Jul/30/19 06:39am

STATE	PROJECT DESIGNATION	YEAR	SHEET NO.	TOTAL SHEETS
ALASKA	0A45028/Z606570000	2020	F31	39

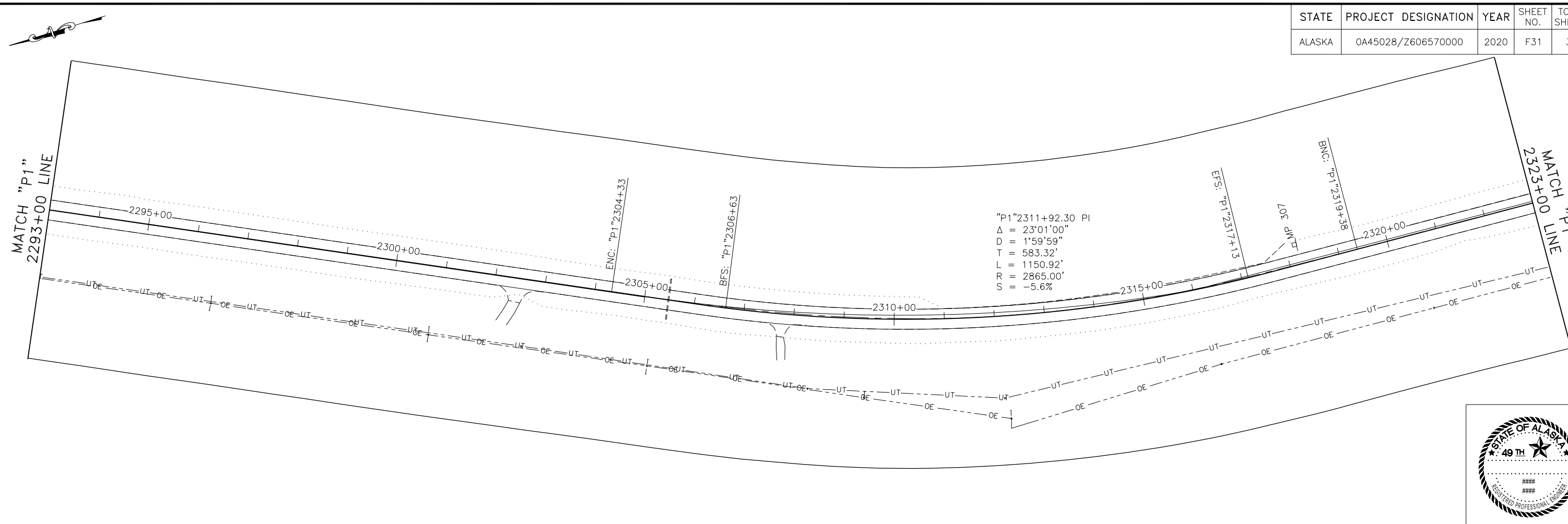

\\MANHFS1.bkr.mbakercorp.com\PROJECTS\AKDOT\148830 - DOT&PF Parks 305-325 P\04 CADD\Prelim Eng\Alt P1\60657\_CM\_P1 P&P-2293+00.00-2323+00.00 Tue, Jul/30/19 06:41am

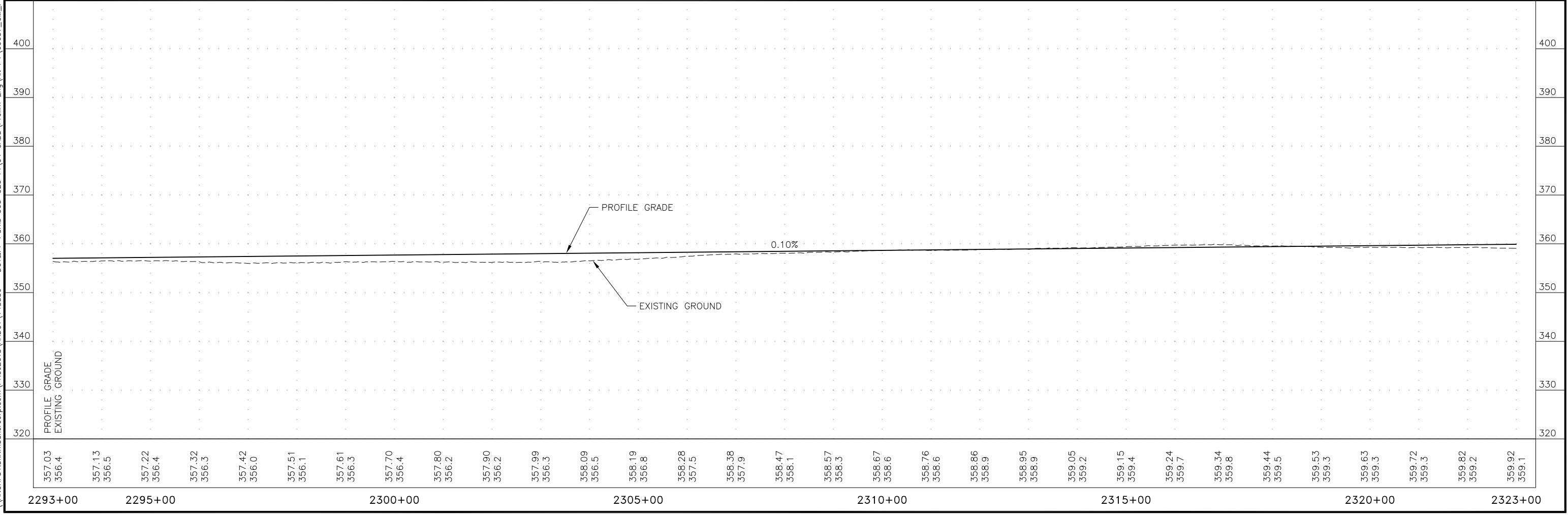

STATE	PROJECT DESIGNATION	YEAR	SHEET NO.	TOTAL SHEETS
ALASKA	0A45028/Z606570000	2020	F32	39

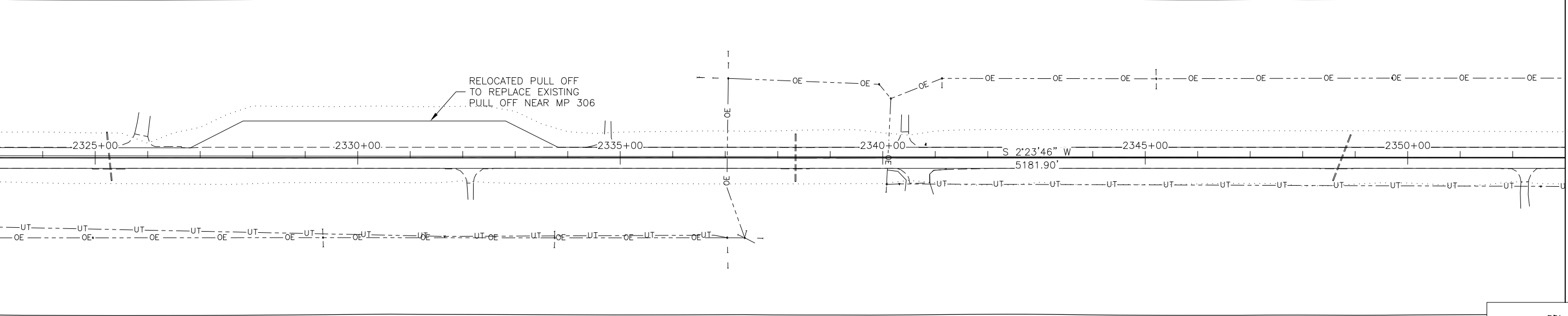

\\ANCHFS1.bkr.mbakercorp.com\PROJECTS\AKDOT\148830 - DOT&PF Parks 305-325 P\04 CADD\Prelim Eng\Alt P1\60657\_CM\_P1 P&P-2323+00.00-2353+00.00 Tue, Jul/30/19 06:43am

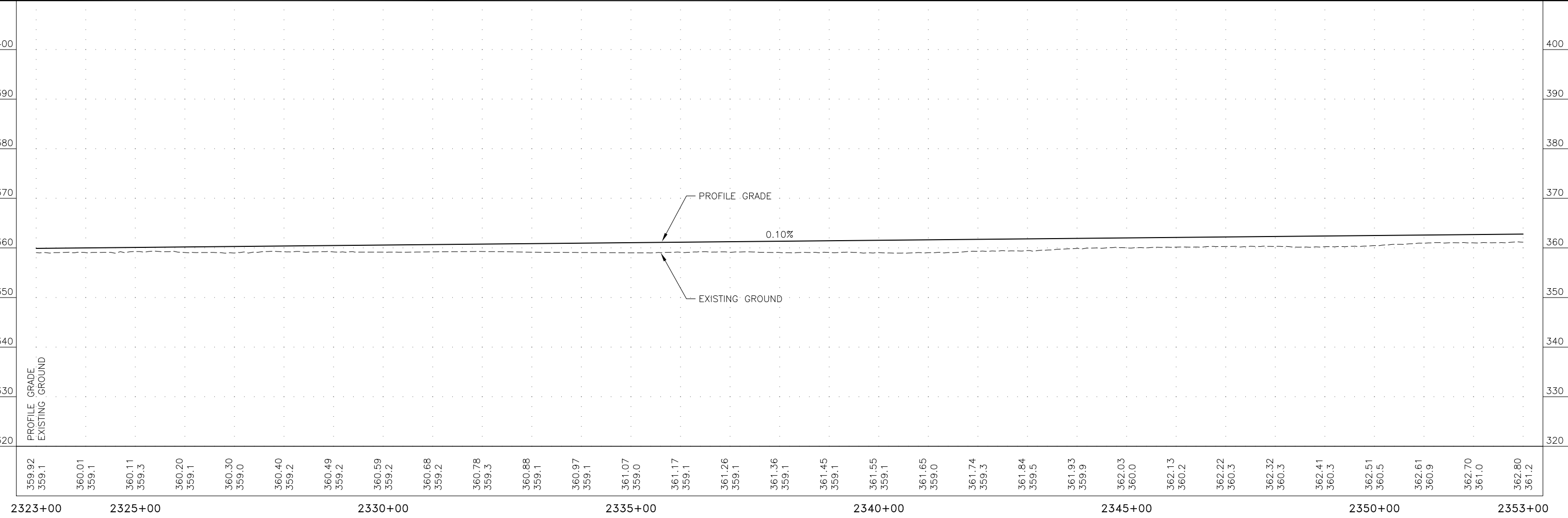



STATE	PROJECT DESIGNATION	YEAR	SHEET NO.	TOTAL SHEETS
ALASKA	0A45028/Z606570000	2020	F33	39

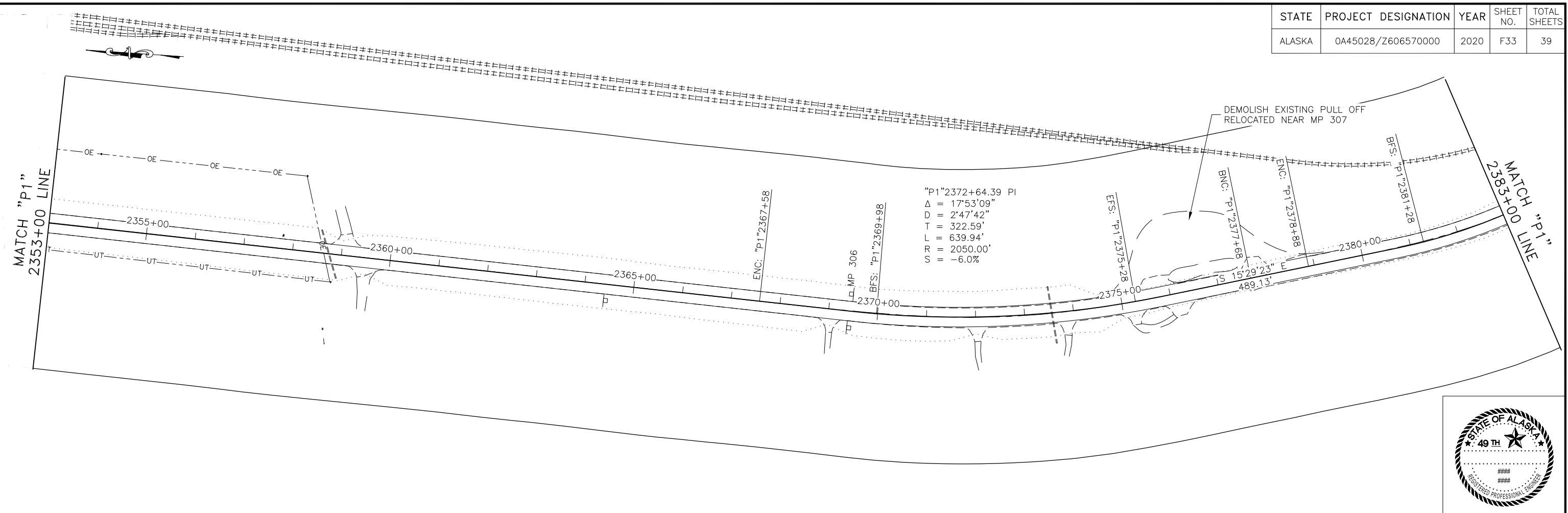

\\MCHFS1.bkr.mbakercorp.com\PROJECTS\_AKDOT\148830 - DOT&PF Parks 305-325 P\04 CADD\Prelim Eng\Alt P1\60657\_CM\_P1 P&P-2353+00.00-2383+00.00 Tue, Jul/30/19 06:45am

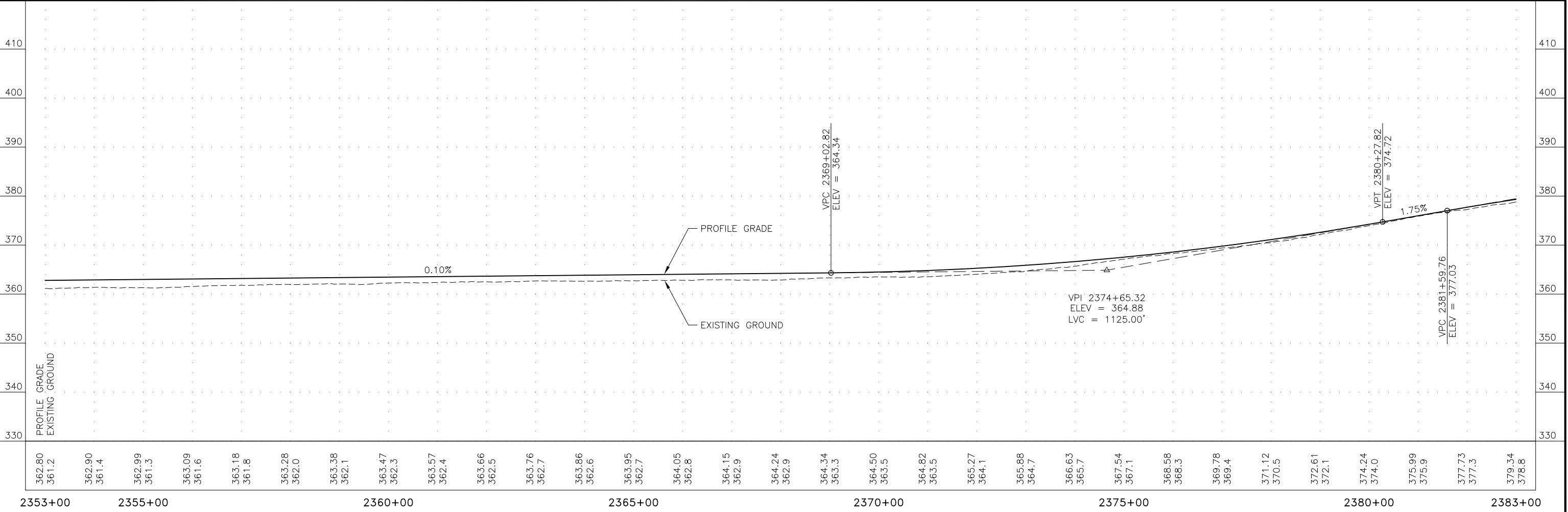

STATE	PROJECT DESIGNATION	YEAR	SHEET NO.	TOTAL SHEETS
ALASKA	0A45028/Z606570000	2020	F34	39

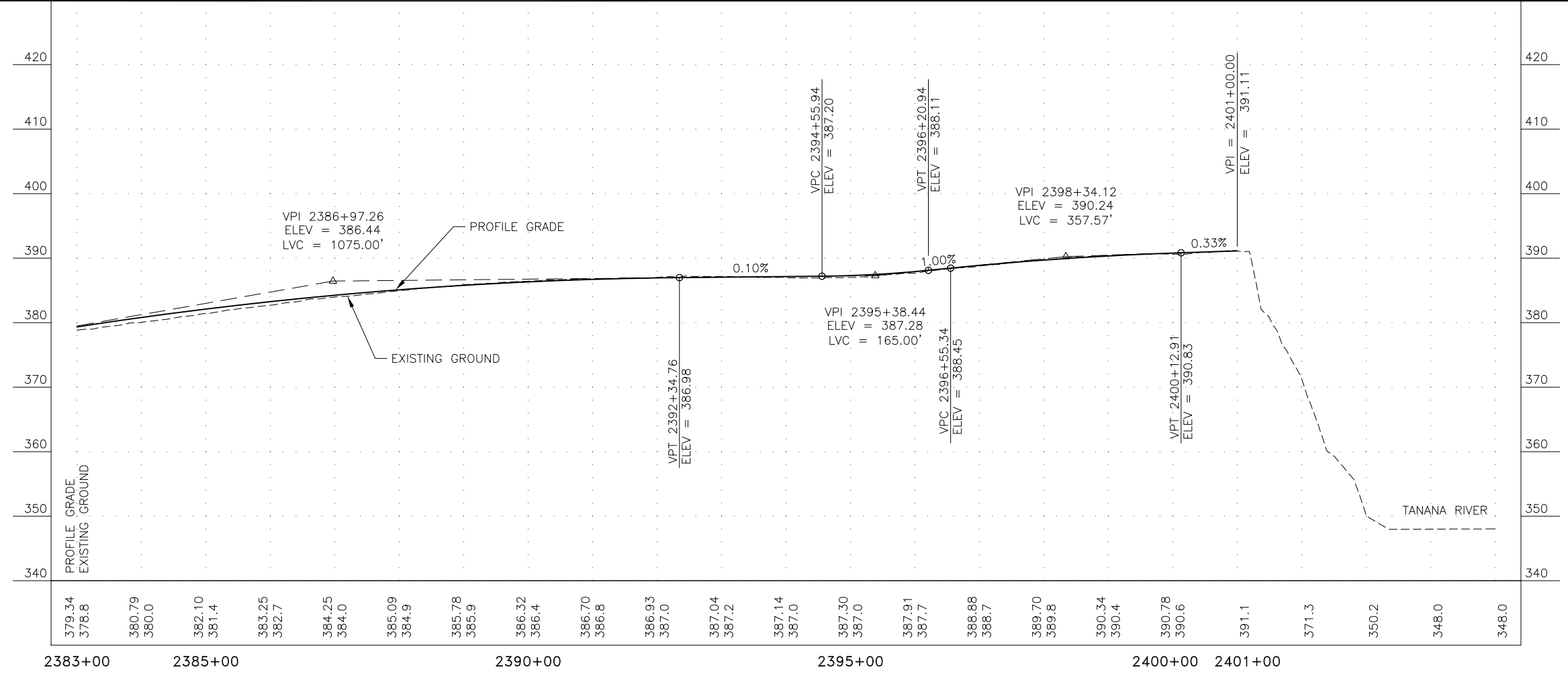
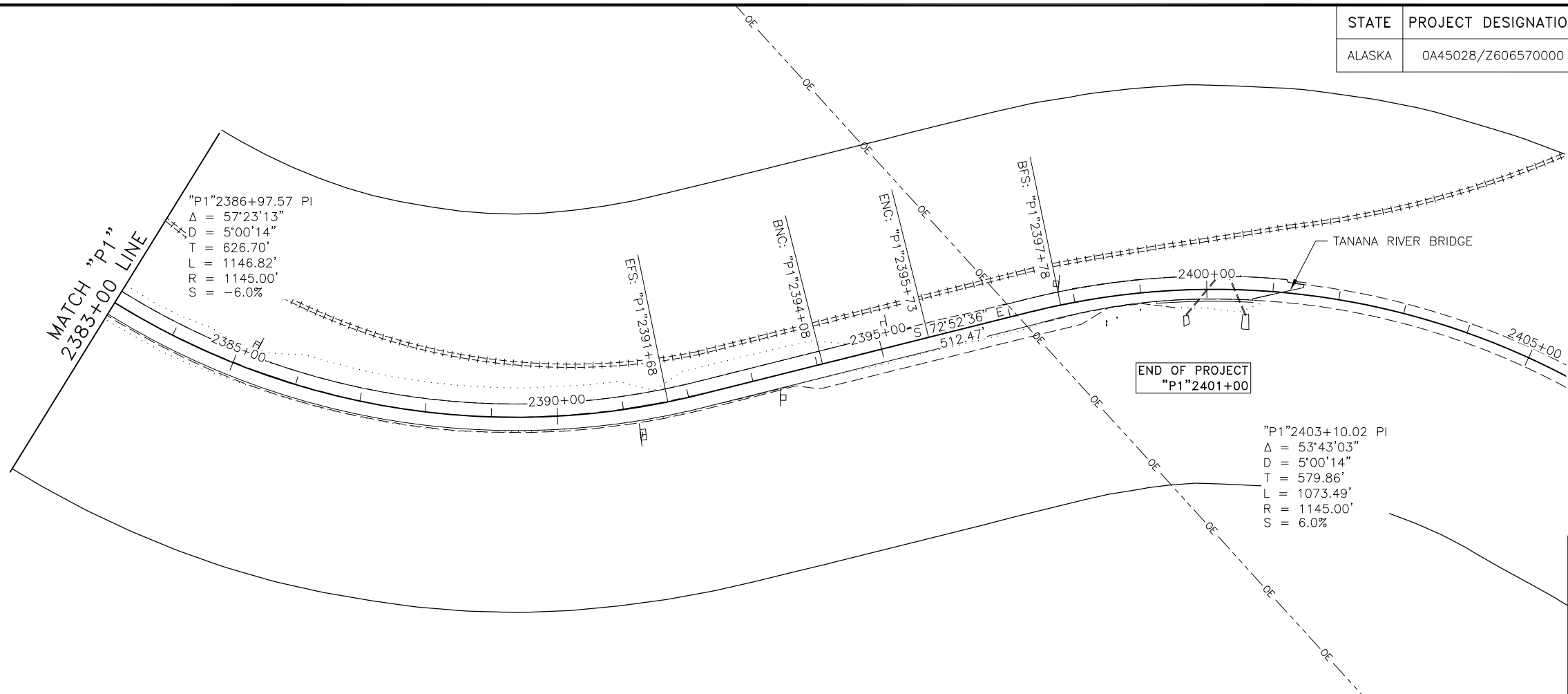

\\MANHFS1.bkr.mbakercorp.com\PROJECTS\AKDOT\148830 - DOT&PF Parks 305-325 PI\04 CADD\Prelim Eng\Alt P1\60657\_CM\_P1 P&P-2383+00.00-2401+00.00 Tue, Jul/30/19 06:47am

**Appendix F**  
**PRELIMINARY BRIDGE PLANS**

STATE	PROJECT DESIGNATION	YEAR	SHEET NO.	TOTAL SHEETS
ALASKA	Z606570000/OA45028	2019	N1	TtIShts

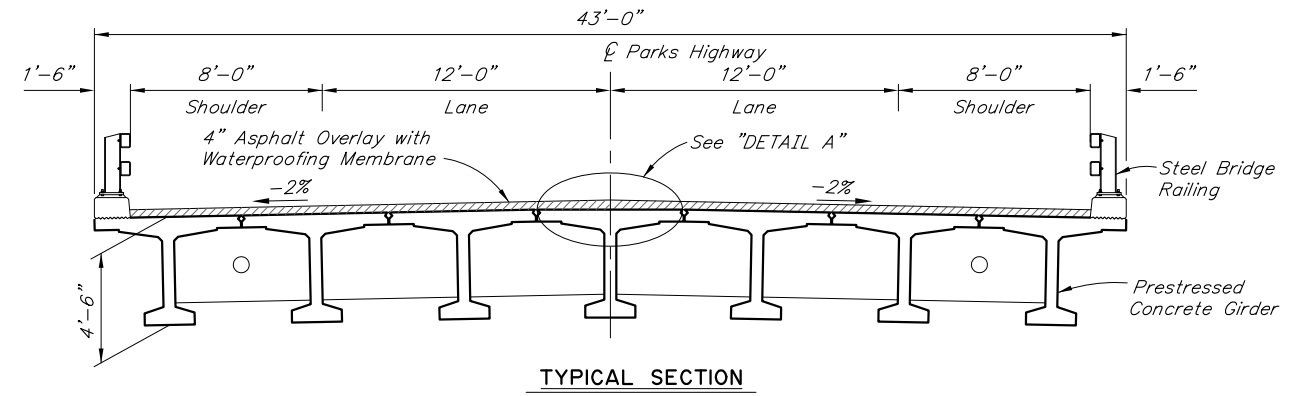
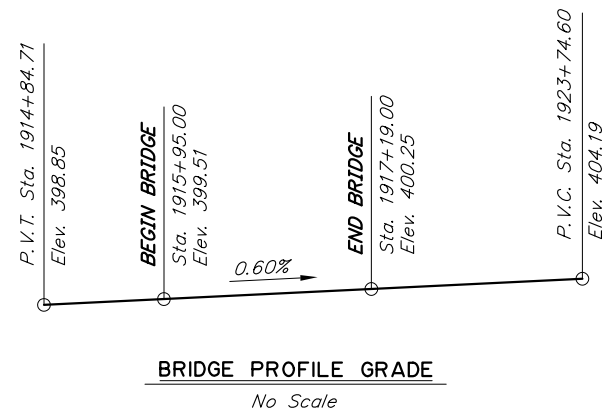

TYPICAL SECTION

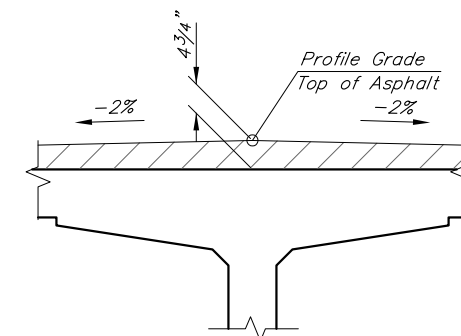
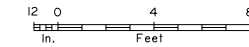

DETAIL A

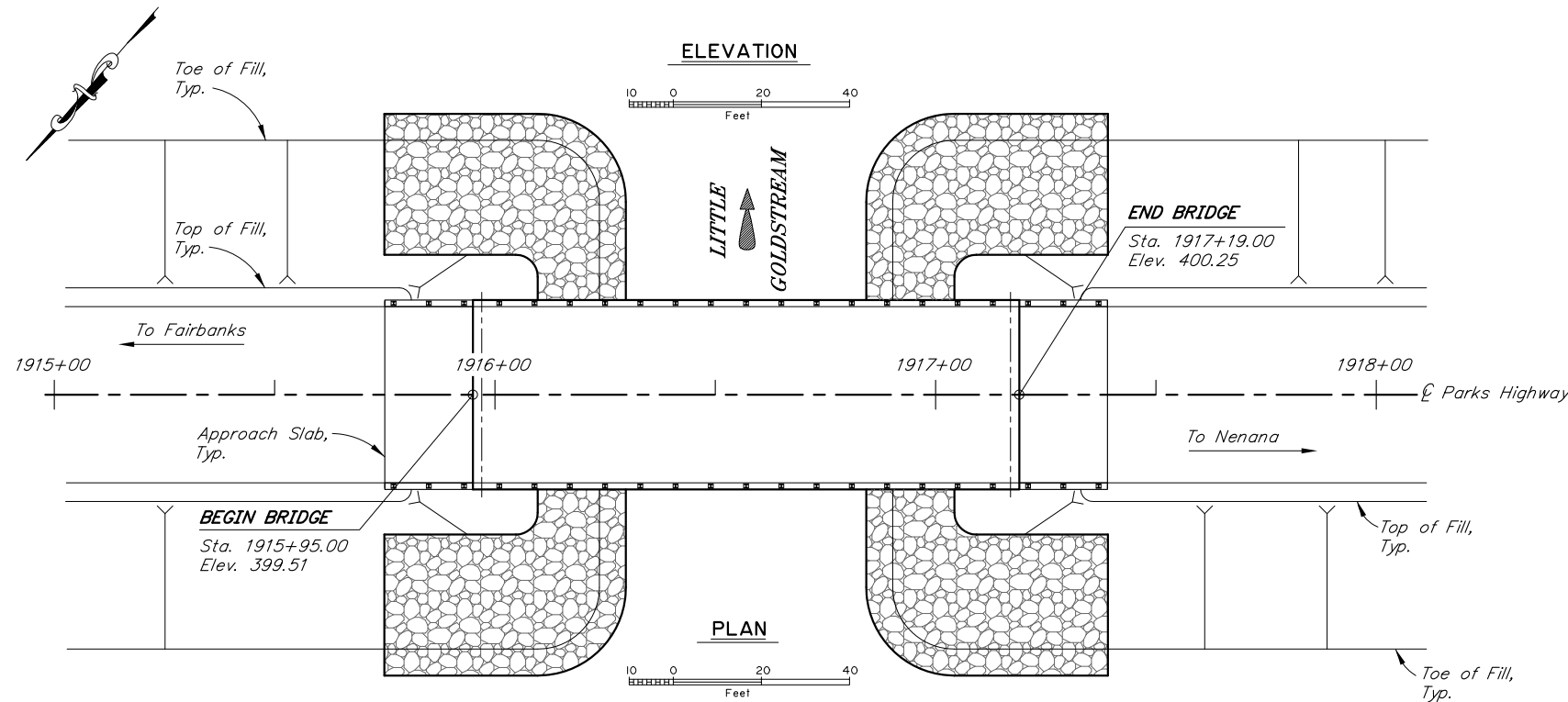
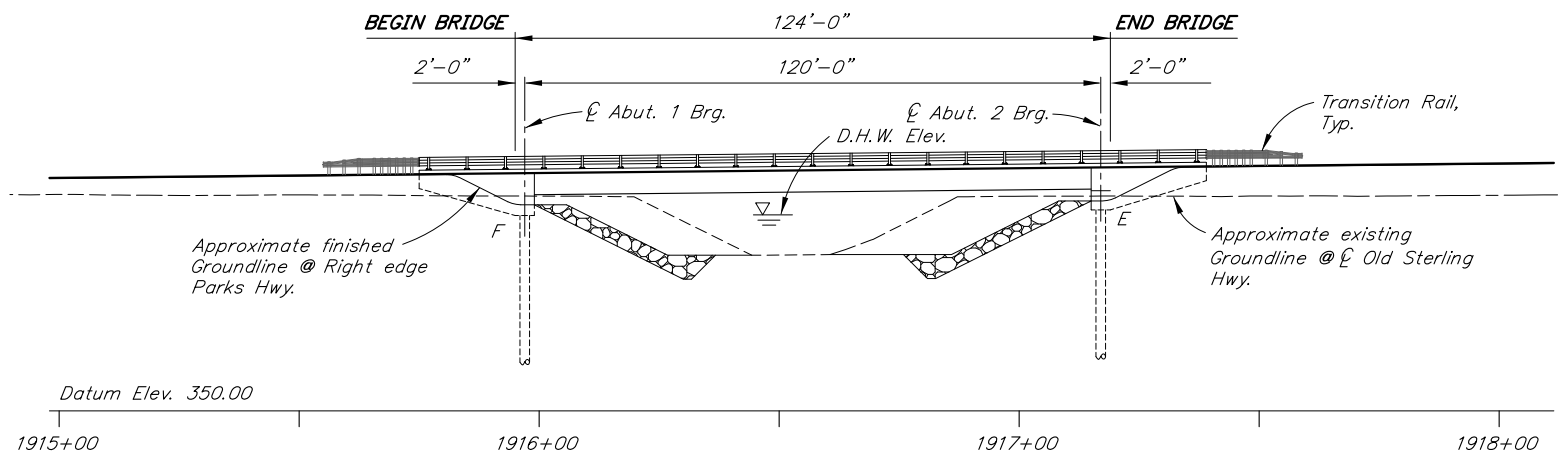
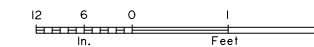

DRAWING INDEX	
TITLE	DWG. NO.
GENERAL LAYOUT	1
SITE PLAN	2
RIPRAP LAYOUT	3
RIPRAP SECTIONS	4
ABUTMENT 1	5
ABUTMENT 2	6
ABUTMENT DETAILS	7
WINGWALLS	8
FRAMING PLAN AND TYPICAL SECTION	9
GIRDERS	10
GIRDER DETAILS	11
APPROACH SLAB	12
STEEL BRIDGE RAILING, 2-TUBE	13
THREE BEAM TRANSITION, 2-TUBE	14
TEST HOLE & PENETROMETER LOCATION	15
TEST HOLE & PENETROMETER LOGS	16-

**PRELIMINARY PLAN**

**NOTES**

① Approximate location of Bridge Number Plate.

R:\cadd\678\678-GENERAL LAYOUT Thu, Aug/29/19 02:35pm

DESIGNED BY: <i>Designed</i>	CHECKED BY: <i>Checker</i>	LAYOUT BY: <i>Designed</i>	CHECKED BY: <i>Checker</i>
DRAWN BY: <i>Drafter</i>	CHECKED BY: <i>Designed</i>	SPECIFICATIONS BY: <i>Designed</i>	P S & E COMPARED: <i>Checker</i>
QUANTITIES BY: <i>Designed</i>	CHECKED BY: <i>Checker</i>	APPROVAL RECOMMENDED BY:	<i>Engineer</i>

STATE OF ALASKA  
**DEPARTMENT OF TRANSPORTATION  
AND PUBLIC FACILITIES**  
BRIDGE SECTION  
3132 Channel Drive  
Juneau, Alaska 99801  
907-465-2975

**LITTLE GOLDSTREAM BRIDGE**  
PARKS HIGHWAY  
**GENERAL LAYOUT**



BRIDGE NO. 678  
DWG. NO. 1

STATE	PROJECT DESIGNATION	YEAR	SHEET NO.	TOTAL SHEETS
ALASKA	Z606570000/OA45028	2019	N2	TtiShts

**GENERAL NOTES**

DESIGN:..... AASHTO LRFD Bridge Design Specifications, 2017 Edition, with latest interim specifications.

Seismic design per AASHTO Guide Specifications for LRFD Seismic Bridge Design, 2011 with latest interim revisions.

LIVE LOAD:..... HL-93

DEAD LOAD:..... Includes 50 psf for all wearing surfaces.

SEISMIC PARAMETERS:..... PGA = 0.27  
 S<sub>s</sub> = 0.63  
 S<sub>1</sub> = 0.21  
 Site Class = D  
 Liquefaction Potential = Low  
 AASHTO 7% probability of exceedance in 75 years.

REINFORCEMENT:..... ASTM A706, Grade 60, F<sub>y</sub> = 60,000 psi  
 ASTM A970 Headed bars, Class HA.  
 Space reinforcement evenly unless otherwise noted.

PRESTRESSED CONCRETE:..... See Girder Drawings.

CONCRETE:..... Class A Concrete unless otherwise noted, f'c = 4000 psi

STRUCTURAL STEEL:..... ASTM A709, Grade 36T3, F<sub>y</sub> = 36,000 psi  
 Galvanize structural steel in accordance with AASHTO M111 unless shown otherwise.

STRUCTURAL STEEL PILING:..... API 5L X52 PSL2, F<sub>y</sub> = 52,000 psi.  
 Pile Tip reinforcing is required.

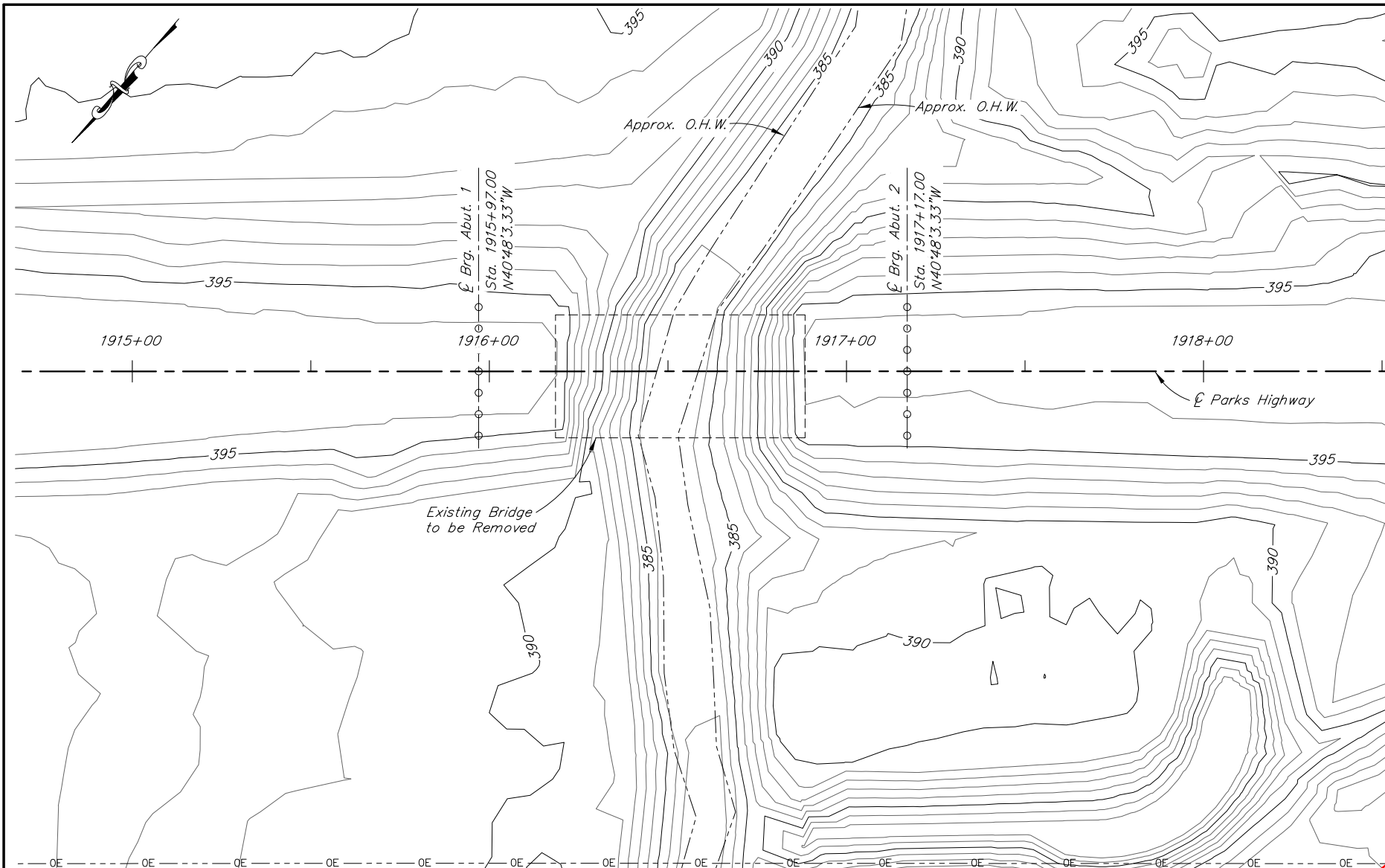

PILE DATA TABLE							
LOCATION	PILE TYPE	DRIVING CRITERIA			DESIGN DATA		
		MINIMUM PENETRATION (ft)	ESTIMATED PILE TIP ELEVATION (ft)	DRIVING RESISTANCE (K)	STRENGTH I FACTORED LOAD (K)	NOMINAL RESISTANCE (K)	RESISTANCE FACTOR, φ
Abutment 1	2'-0"Øx1/2" Pile						0.65
Abutment 2	2'-0"Øx1/2" Pile						0.65

**ABBREVIATIONS:**

**ABBREVIATIONS:**

- ℄ = centerline
- ℄ = plate
- & = and
- @ = at
- ∅ = diameter
- ± = approximate
- Abut. = abutment
- Approx. = approximate
- b.f. = back/dirt face
- bot. = bottom
- Br. = bridge
- btwn. = between
- Brg. = Bearings
- C.I.P. = cast in place
- Clr. = clear, clearance
- CY = cubic yard
- dia. = diameter
- Dwg. = drawing
- E = expansion
- (E) = existing
- EA = each
- Elev. = elevation
- e.f. = each face
- e.w. = each way
- f0--- = fiber optic line
- F = fixed
- f.f. = front/air face
- g--- = underground gas line
- Hwy. = highway
- ksf = 1000 pounds per square foot
- LB = pound
- LF = linear foot
- LS = lump sum
- Lt. = left
- max. = maximum
- min. = minimum
- n.f. = near face
- No. = number
- o.c. = on center
- O.H.W. = ordinary high water
- oe--- = overhead electrical line
- ot--- = overhead telephone line
- psf = pounds per square foot
- psi = pounds per square inch
- PVC = point of vertical curve
- PVI = point of vertical intersection
- PVT = point of vertical tangent
- R.O.W. = right of way
- Rt. = right
- Rd. = road
- spc. = space, spaces
- Sta. = station
- SF = square feet
- Symm. = symmetric
- Typ. = typical
- ue--- = underground electrical line
- ut--- = underground telephone line
- w/ = with

TBD - WAITING FOR SFER

PRELIMINARY PLAN

**ESTIMATE OF QUANTITIES**

ITEM NO.	ITEM	PAY UNIT	ESTIMATING UNIT	SUBST.	SUPERST.	TOTAL QUANTITY
202.0023.0000	Removal of Bridge	LS	SF			
203.0003.0000	Unclassified Excavation	CY	CY			
205.0006.0000	Structural Fill	CY	CY			
501.0001.0000	Class A Concrete	LS	CY			
501.0007.0000	Precast Concrete Member, 122'-6" Decked Bulb-Tee	EA	EA			
503.0001.0000	Reinforcing Steel	LS	LBS			
503.0002.0000	Epoxy-Coated Reinforcing Steel	LS	LBS			
505.0005.2405	Furnish Structural Steel Piles, 2'-0" Dia. x 1/2" Pipe	LF	LF			
505.0006.2405	Drive Structural Steel Piles, 2'-0" Dia. x 1/2" Pipe	EA	EA			
507.0001.0002	Steel Bridge Railing, 2-Tube	LF	LF			
508.0001.0000	Waterproofing Membrane, Spray-Applied	LS	SF			
520.0001.0000	Temporary Crossings	LS	LS			
606.0016.0000	Transition Rail	EA	EA			
611.0001.0002	Riprap, Class II	CY	CY			
631.0002.0001	Geotextile, Erosion Control, Class 1	SY	SY			

Item numbers are for reference only. Quantities shown are not necessarily the pay quantities nor the total quantity of the particular item.

DESIGNED BY: Leslie Daugherty	CHECKED: checker	HYDRAULICS BY: Engineer	CHECKED BY: Engineer
DRAWN BY: Drafter	CHECKED: Leslie Daugherty	FOUNDATIONS REVIEWED BY:	Engineer
QUANTITIES BY: Leslie Daugherty	CHECKED: checker		

STATE OF ALASKA  
**DEPARTMENT OF TRANSPORTATION  
 AND PUBLIC FACILITIES**  
 BRIDGE SECTION  
 3132 Channel Drive  
 Juneau, Alaska 99801  
 907-465-2975

**LITTLE GOLDSTREAM BRIDGE**  
 PARKS HIGHWAY  
**SITE PLAN**



BRIDGE NO. 678  
 DWG. NO. 2

R:\cadd\678\678-SITE PLAN Thu, Aug/29/19 02:35pm



STATE	PROJECT DESIGNATION	YEAR	SHEET NO.	TOTAL SHEETS
ALASKA	Z606570000/OA45028	2019	N3	TtShts

R:\cdd\678\678-RIPRAP LAYOUT Thu, Aug/29/19 02:35pm

DESIGNED BY:	<i>Designer</i>	CHECKED:	<i>Checker</i>
DRAWN BY:	<i>Sam Sollie</i>	CHECKED:	<i>Designer</i>
QUANTITIES BY:	<i>Designer</i>	CHECKED:	<i>Checker</i>

**PRELIMINARY PLAN**

STATE OF ALASKA  
DEPARTMENT OF TRANSPORTATION  
AND PUBLIC FACILITIES  
BRIDGE SECTION  
3132 Channel Drive  
Juneau, Alaska 99801  
907-465-2975

**LITTLE GOLDSTREAM BRIDGE**  
PARKS HIGHWAY  
**RIPRAP LAYOUT**



BRIDGE NO. 678  
DWG. NO. 3

STATE	PROJECT DESIGNATION	YEAR	SHEET NO.	TOTAL SHEETS
ALASKA	Z606570000/OA45028	2019	N4	TtShts

R:\cod\678\678-RIPRAP-DETAILS Thu, Aug/29/19 02:35pm

DESIGNED BY:	<i>Designer</i>	CHECKED:	<i>Checker</i>
DRAWN BY:	<i>Sam Sollie</i>	CHECKED:	<i>Designer</i>
QUANTITIES BY:	<i>Designer</i>	CHECKED:	<i>Checker</i>

**PRELIMINARY PLAN**

STATE OF ALASKA  
DEPARTMENT OF TRANSPORTATION  
AND PUBLIC FACILITIES  
BRIDGE SECTION  
3132 Channel Drive  
Juneau, Alaska 99801  
907-465-2975

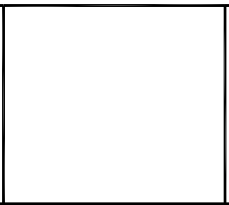

**LITTLE GOLDSTREAM BRIDGE**  
PARKS HIGHWAY  
**RIPRAP DETAILS**



BRIDGE NO. 678  
DWG. NO. 4

STATE	PROJECT DESIGNATION	YEAR	SHEET NO.	TOTAL SHEETS
ALASKA	Z606570000/OA45028	2019	N38	TtShts

**REINFORCING STEEL - ABUTMENT 1**

MARK	NOTE	SIZE	NO.	LENGTH	TYPE	BENDING DIAGRAM
A401	S	4	7	388'-2"	SPIRAL	
A402		4	4	VARIES	STIRRUP	
A403		4	49	6'-0"	HOOP	
A404		4	70	4'-8"	BENT	
A501	E	5	38	16'-11"	STIRRUP	
A601	E,M	6	8	39'-8"	---	
A602	E,M,S	6	6	42'-8"	---	
A701	E	7	8	3'-0"	BENT	
A801		8	56	60'-0"	---	
A802		8	10	42'-8"	---	
A803		8	30	6'-0"	---	
A1001	H,S	10	7	42'-8"	HEADED	
A1002	H,M,S	10	7	42'-8"	HEADED	

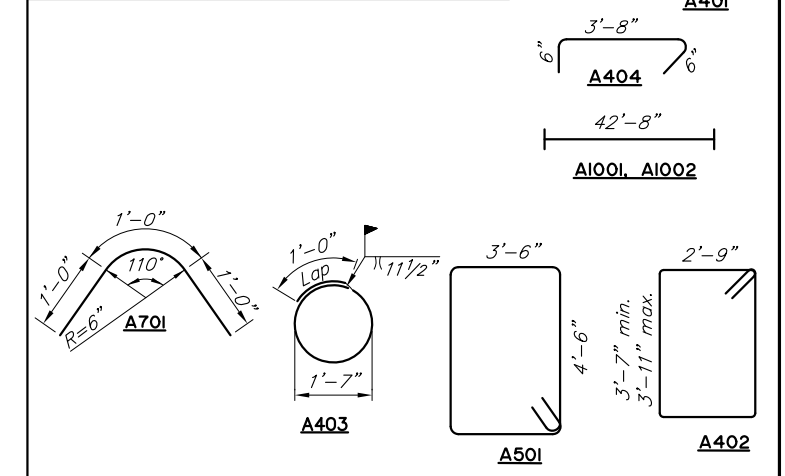

E - Epoxy-Coated  
H - Headed reinforcing steel  
M - Field adjust to match cross slope  
S - Splice permitted. Splice length not included

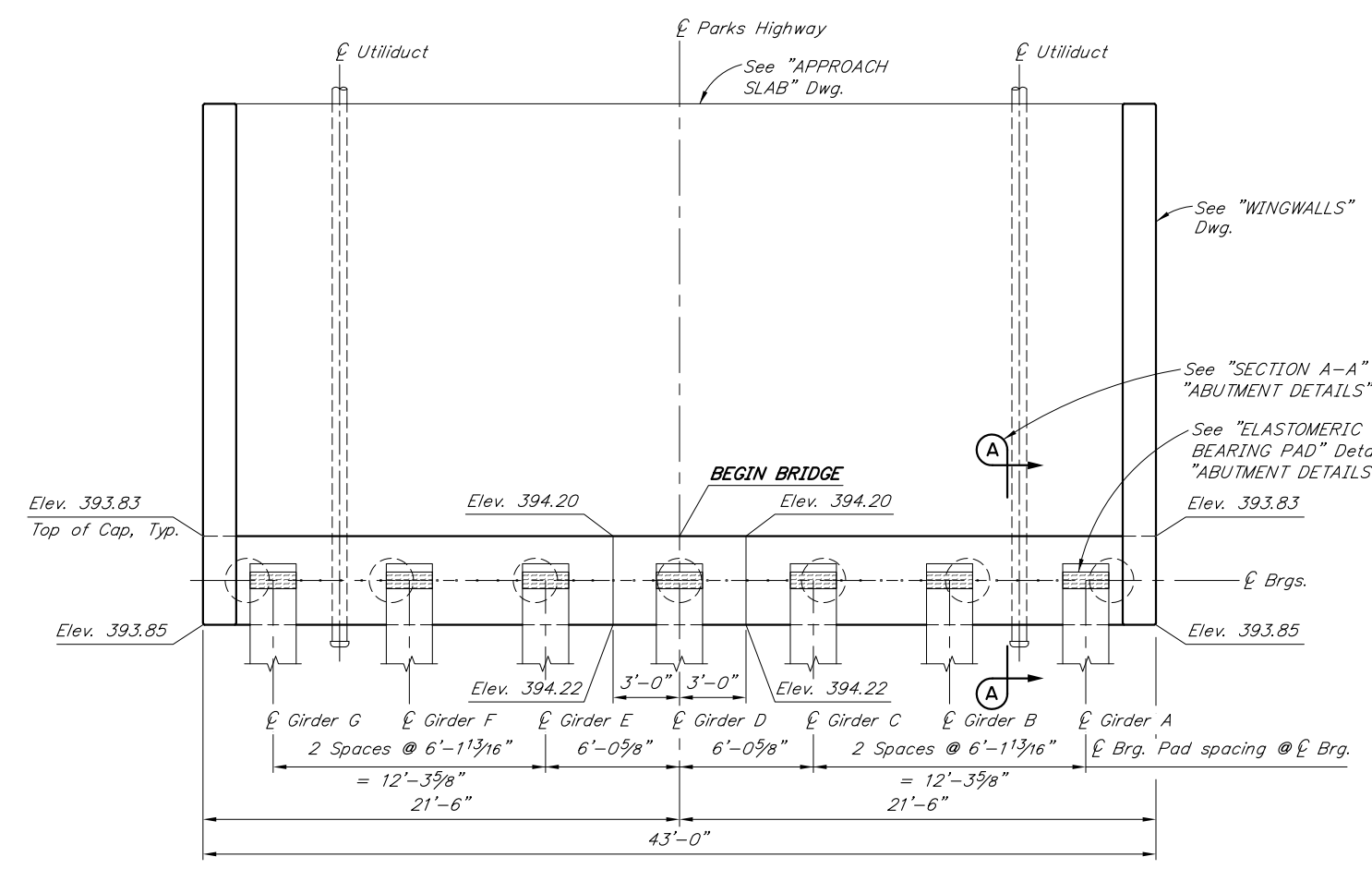

**PLAN**

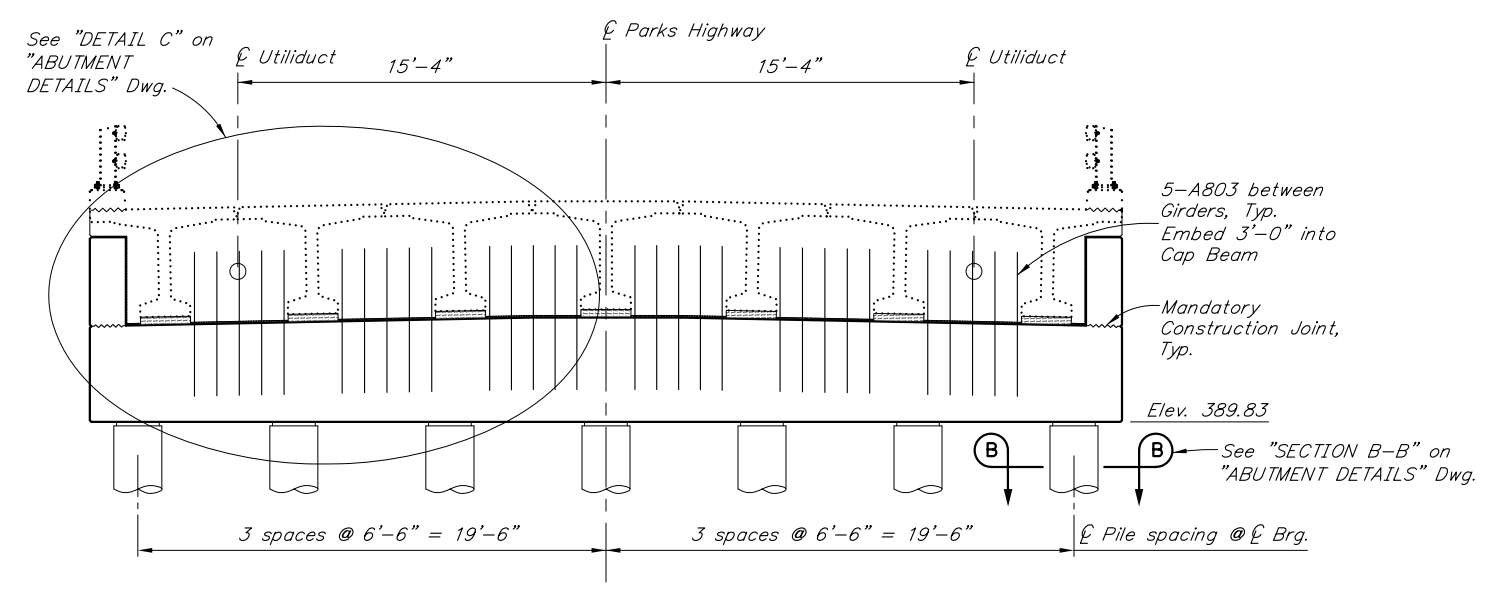

**ELEVATION**  
(Looking back on Station)

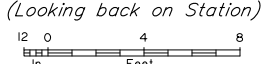

R:\cadd\678\678-1-ABUT 1 Thu, Aug/29/19 02:35pm

DESIGNED BY:	Designer	CHECKED:	Checker
DRAWN BY:	Sam Sollie	CHECKED:	Designer
QUANTITIES BY:	Designer	CHECKED:	Checker

PRELIMINARY PLAN

STATE OF ALASKA  
DEPARTMENT OF TRANSPORTATION  
AND PUBLIC FACILITIES  
BRIDGE SECTION  
3132 Channel Drive  
Juneau, Alaska 99801  
907-465-2975

LITTLE GOLDSTREAM BRIDGE  
PARKS HIGHWAY  
ABUTMENT 1



BRIDGE NO. 678  
DWG. NO. 6

STATE	PROJECT DESIGNATION	YEAR	SHEET NO.	TOTAL SHEETS
ALASKA	Z606570000/OA45028	2019	N39	TtShts

**REINFORCING STEEL - ABUTMENT 2**

MARK	NOTE	SIZE	NO.	LENGTH	TYPE	BENDING DIAGRAM
A401	S	4	7	388'-2"	SPIRAL	
A402		4		VARIES	STIRRUP	
A403		4	49	6'-0"	HOOP	
A404		4	70	4'-8"	BENT	
A501	E	5	38	16'-11"	STIRRUP	
A601	E,M	6	8	39'-8"	---	
A602	E,M,S	6	6	42'-8"	---	
A701	E	7	8	3'-0"	BENT	
A801		8	56	60'-0"	---	
A802		8	10	42'-8"	---	
A1001	H,S	10	7	42'-8"	HEADED	
A1002	H,M,S	10	7	42'-8"	HEADED	

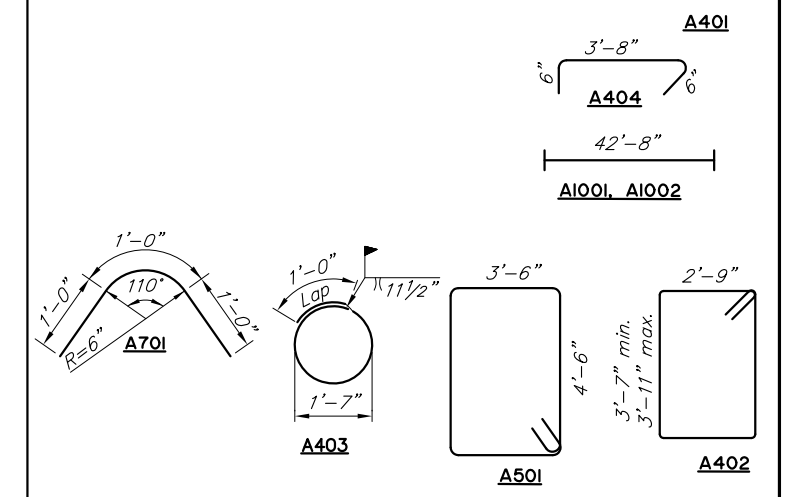

E - Epoxy-Coated  
H - Headed reinforcing steel  
M - Field adjust to match cross slope  
S - Splice permitted. Splice length not included

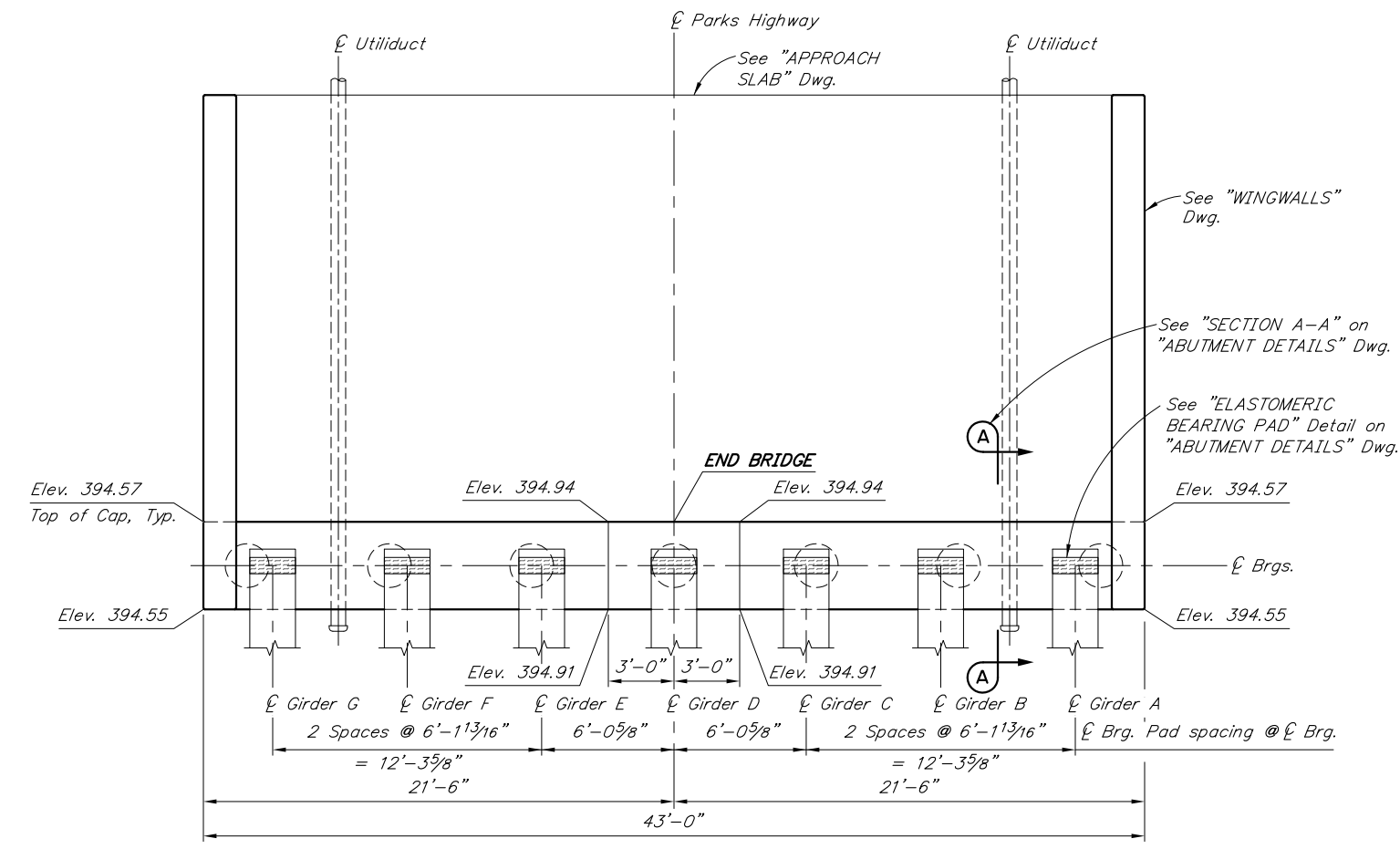

**PLAN**

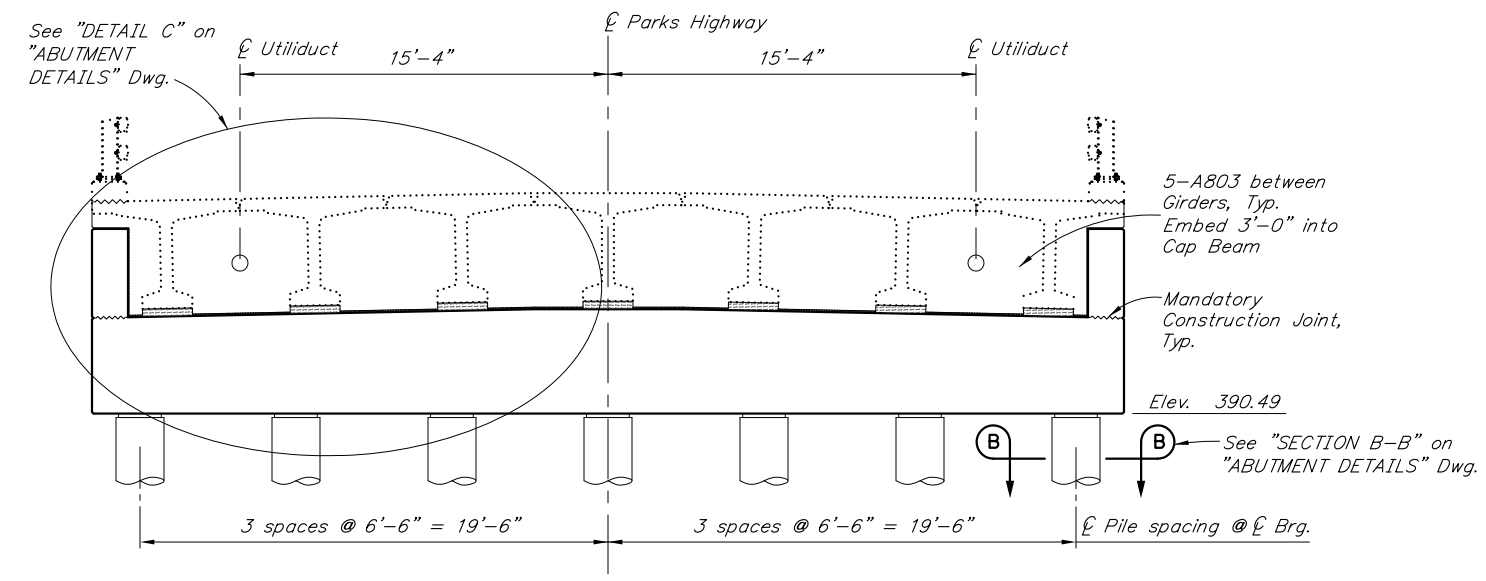

**ELEVATION**

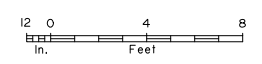

R:\cadd\678\678-1-ABUT 2 Thu, Aug/29/19 02:35pm

DESIGNED BY:	Designer	CHECKED:	Checker
DRAWN BY:	Sam Sollie	CHECKED:	Designer
QUANTITIES BY:	Designer	CHECKED:	Checker

PRELIMINARY PLAN

STATE OF ALASKA  
DEPARTMENT OF TRANSPORTATION  
AND PUBLIC FACILITIES  
BRIDGE SECTION  
3132 Channel Drive  
Juneau, Alaska 99801  
907-465-2975

LITTLE GOLDSTREAM BRIDGE

PARKS HIGHWAY

ABUTMENT 2

BRIDGE NO. 678  
DWG. NO. 7

STATE	PROJECT DESIGNATION	YEAR	SHEET NO.	TOTAL SHEETS
ALASKA	Z606570000/OA45028	2019	N40	TtShts

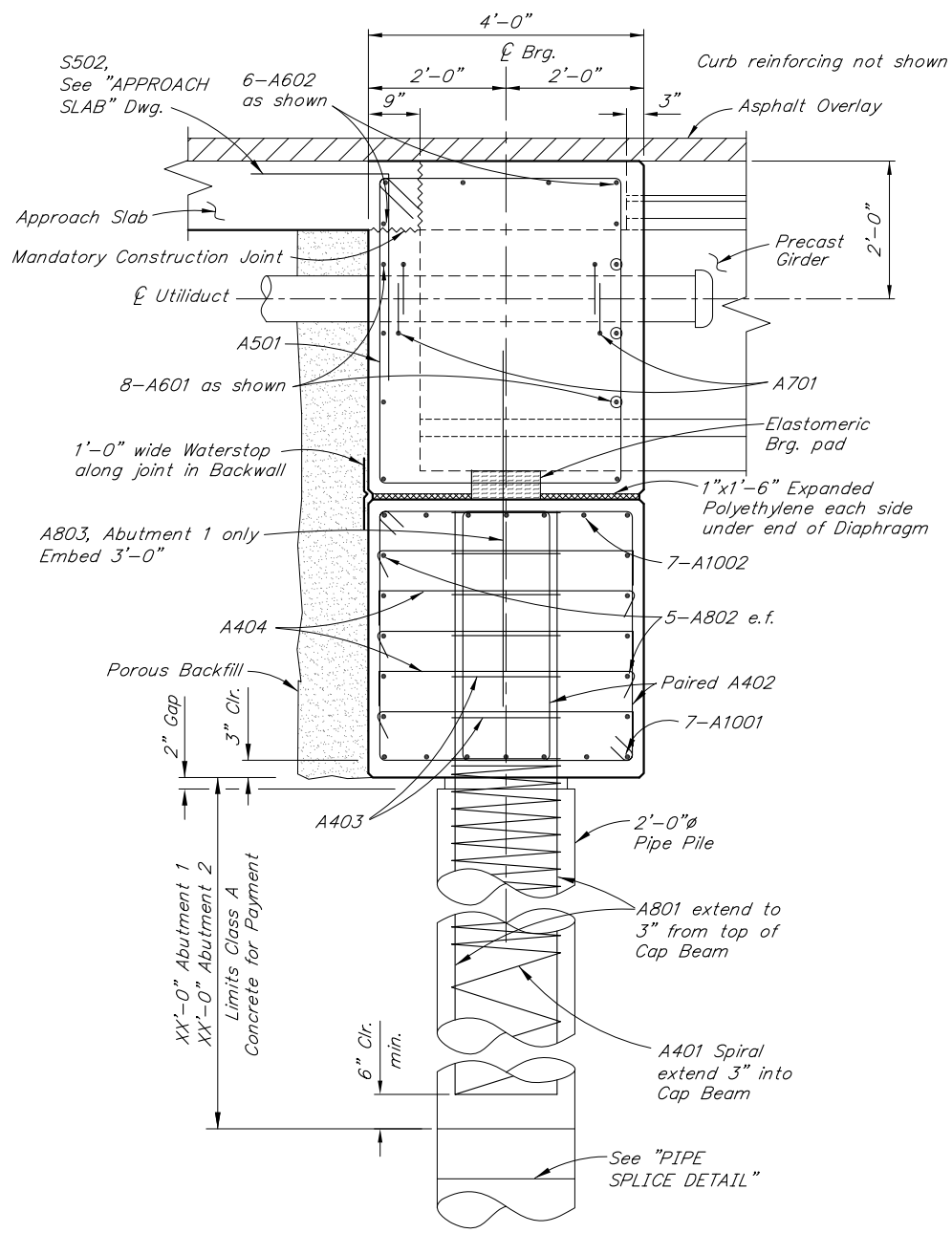

**SECTION A-A**  
(Abutment 1 shown, Abutment 2 similar)

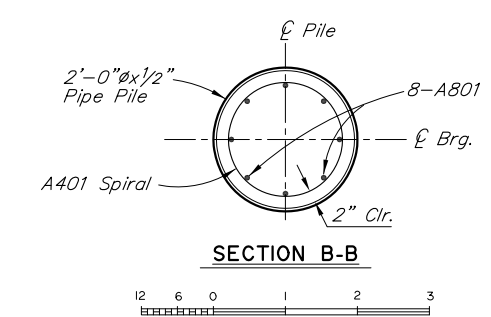

**SECTION B-B**

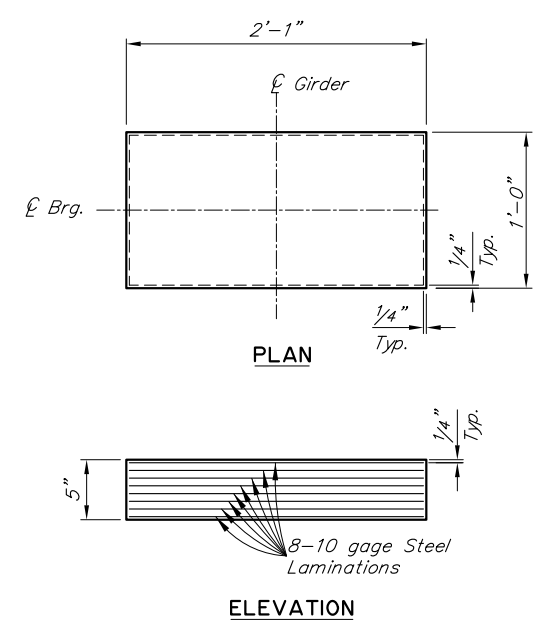
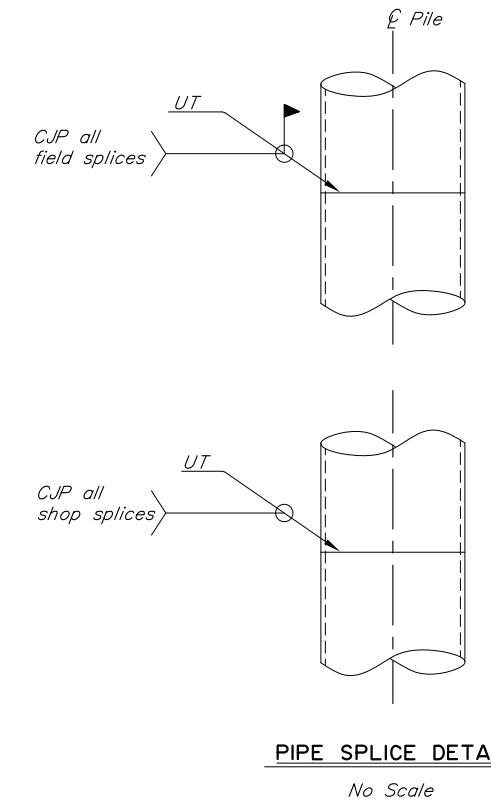

**ELASTOMERIC BEARING PAD**

Grade 5  
 Max. Dead Load = 117 k  
 Max. Live Load = 81 k  
 Shear Modulus = 115 psi

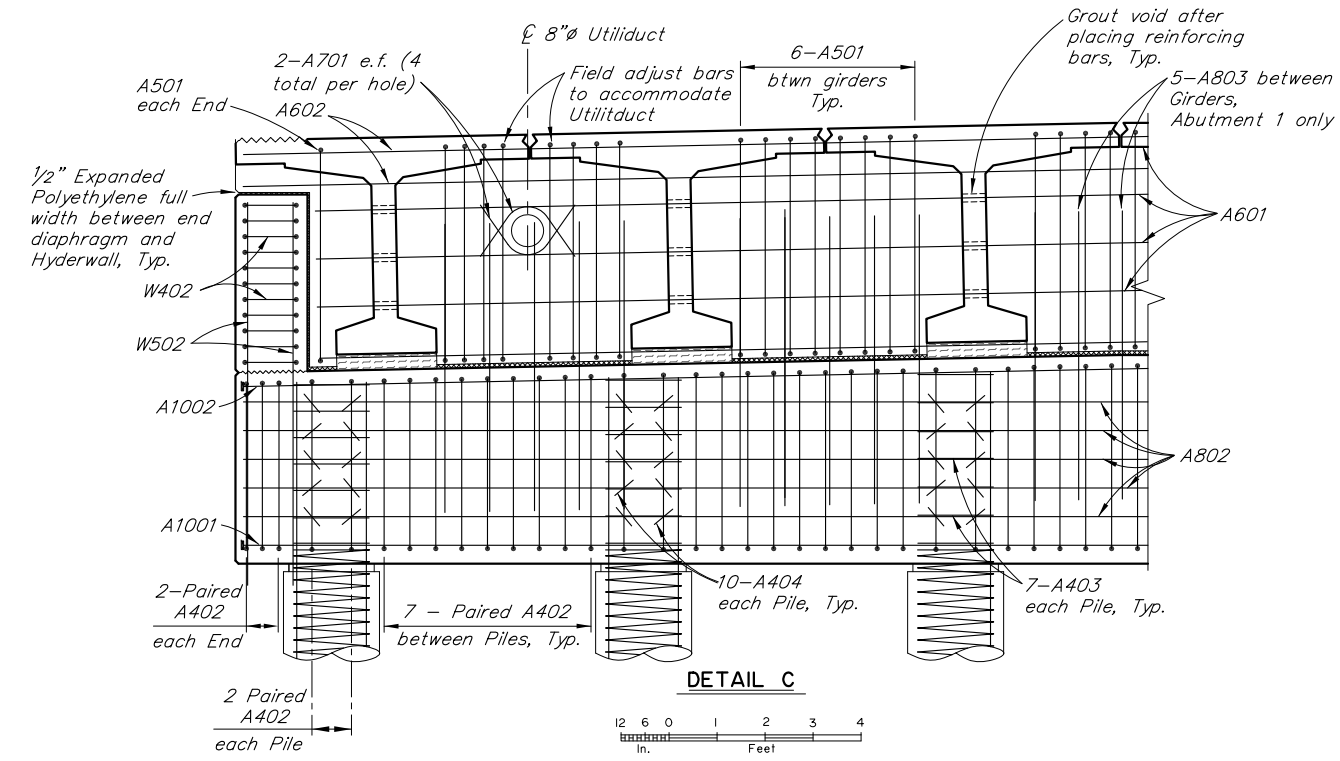

**DETAIL C**

R:\cadd\678\678-1-ABUT 2 (2) Thu, Aug/29/19 02:36pm

DESIGNED BY:	Designer	CHECKED:	Checker
DRAWN BY:	Sam Sollie	CHECKED:	Designer
QUANTITIES BY:	Designer	CHECKED:	Checker

**PRELIMINARY PLAN**

STATE OF ALASKA  
 DEPARTMENT OF TRANSPORTATION  
 AND PUBLIC FACILITIES  
 BRIDGE SECTION  
 3132 Channel Drive  
 Juneau, Alaska 99801  
 907-465-2975

**LITTLE GOLDSTREAM BRIDGE**  
 PARKS HIGHWAY  
**ABUTMENT DETAILS**

BRIDGE NO. 678  
 DWG. NO. 8



STATE	PROJECT DESIGNATION	YEAR	SHEET NO.	TOTAL SHEETS
ALASKA	Z606570000/OA45028	2019	N41	TtShts

REINFORCING STEEL - ONE ABUTMENT						
MARK	NOTE	SIZE	NO.	LENGTH	TYPE	BENDING DIAGRAM
W401		4	84	VARIABLES	---	
W402		4	20	10'-5"	STIRRUP	
W403		4	16	7'-4"	---	
W501		5	22	VARIABLES	---	
W901		9	4	24'-10"	BENT	
W902		9	22	VARIABLES	---	
W903		9	4	21'-1"	BENT	
C402	E	4	32	7'-7"	STIRRUP	
C502	E	5	4	19'-6"	---	

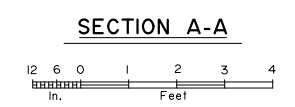
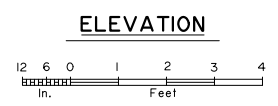
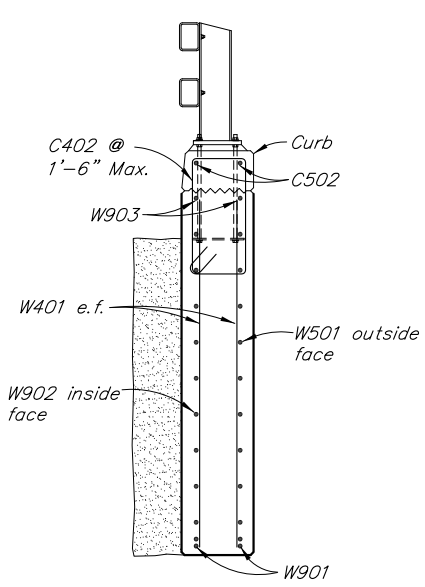
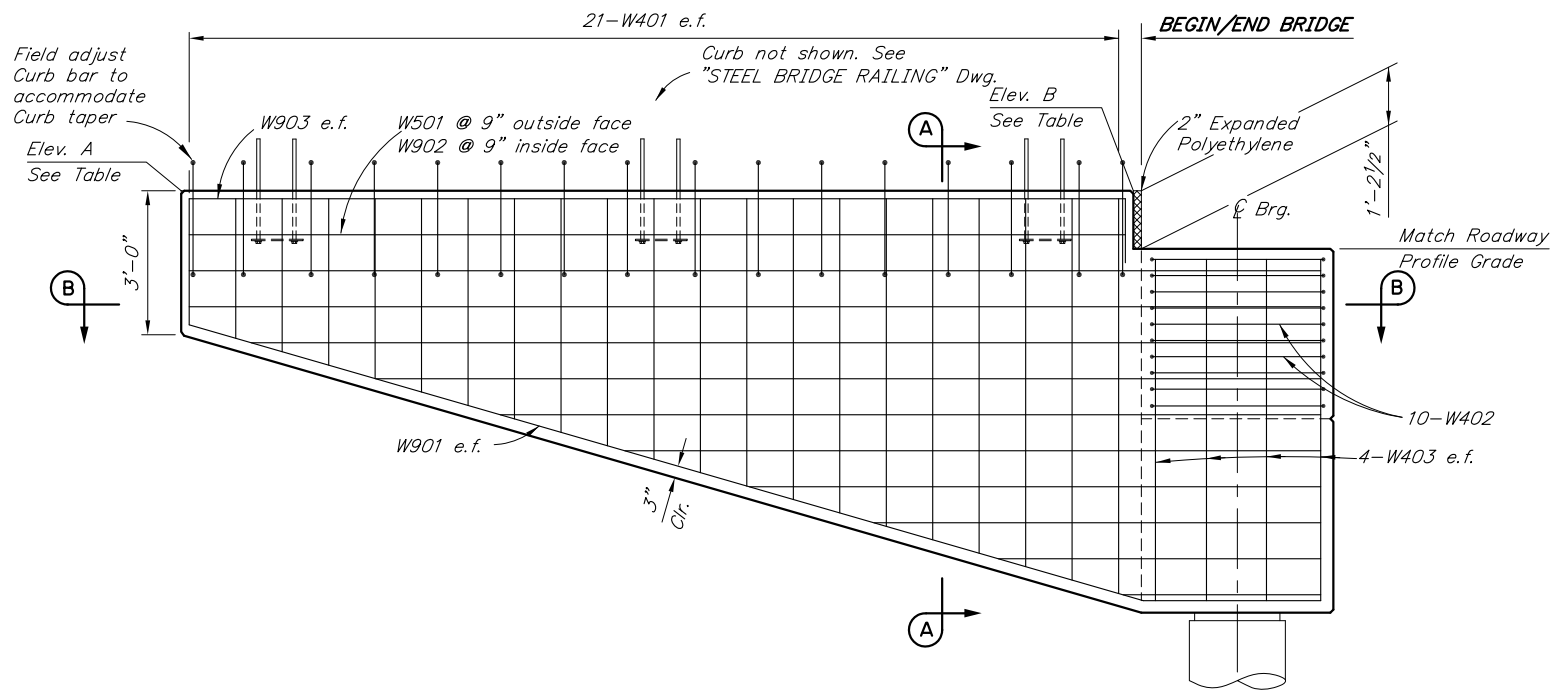

**TOP OF WINGWALL ELEVATION TABLE (FT)**

LOCATION	A	B
ABUTMENT 1	399.38	399.50
ABUTMENT 2	400.53	400.41

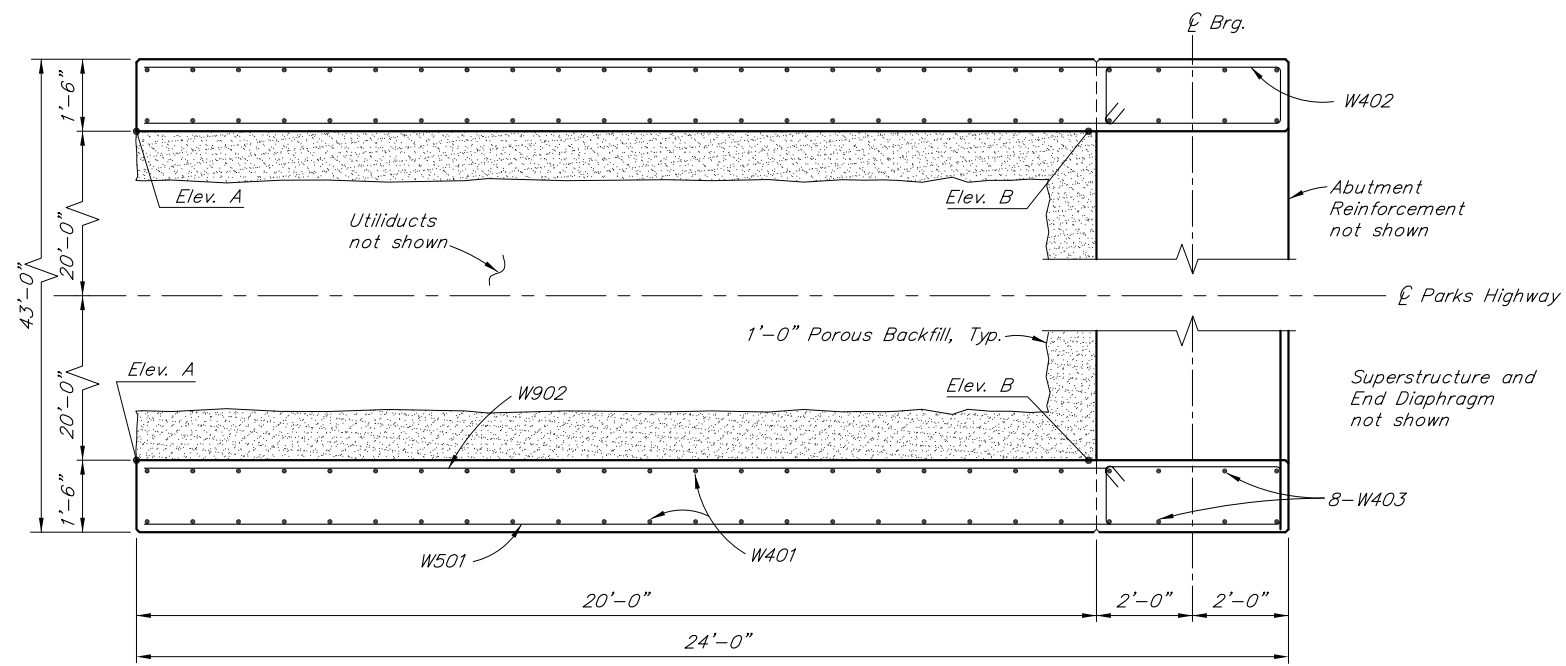

**SECTION B-B**  
(Abutment 1 shown, Abutment 2 similar)

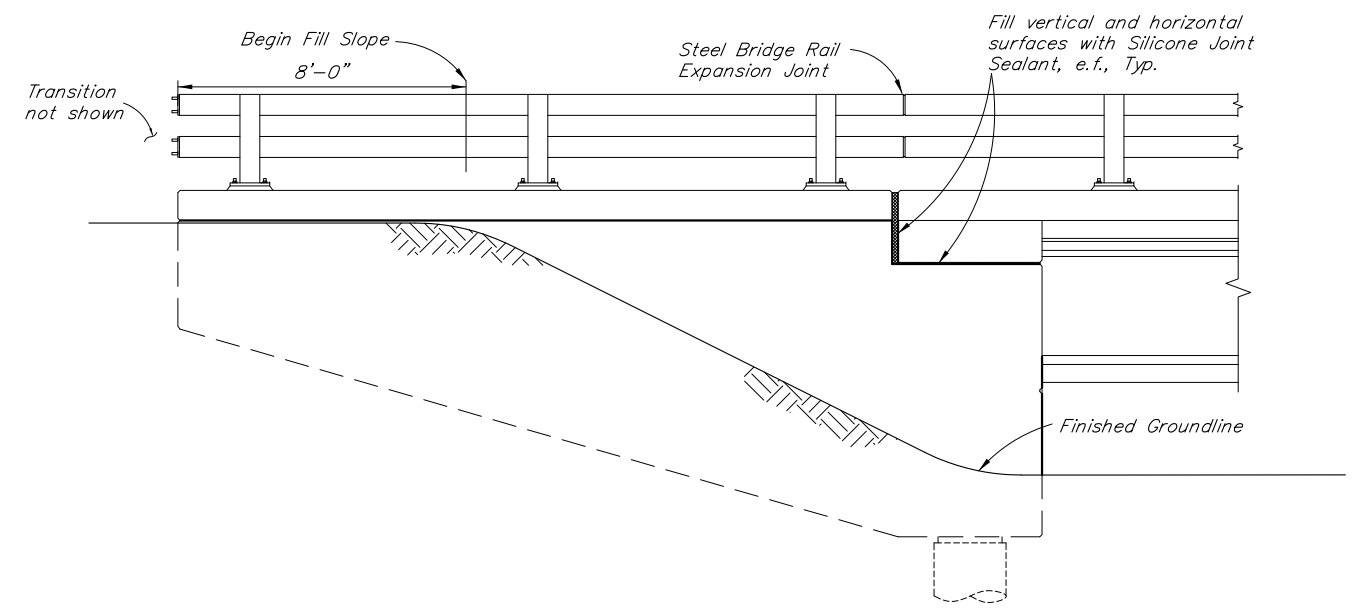

**FINISHED ELEVATION**

R:\cadd\678\678-1-WINGWALLS Thu, Aug/29/19 02:36pm

DESIGNED BY:	Designer	CHECKED:	Checker
DRAWN BY:	Sam Sollie	CHECKED:	Designer
QUANTITIES BY:	Designer	CHECKED:	Checker

**PRELIMINARY PLAN**

STATE OF ALASKA  
DEPARTMENT OF TRANSPORTATION  
AND PUBLIC FACILITIES  
BRIDGE SECTION  
3132 Channel Drive  
Juneau, Alaska 99801  
907-465-2975

**LITTLE GOLDSTREAM BRIDGE**  
PARKS HIGHWAY  
**WINGWALLS**

BRIDGE NO. 678  
DWG. NO. 9

STATE	PROJECT DESIGNATION	YEAR	SHEET NO.	TOTAL SHEETS
ALASKA	Z606570000/OA45028	2019	N42	TtShts

REINFORCING STEEL - ONE DIAPHRAGM						
MARK	NOTE	SIZE	NO.	LENGTH	TYPE	BENDING DIAGRAM
D401	E	4	42	6'-1"	STIRRUP	
D501	E	5	24	5'-3"	---	
D601	E,M,S	6	4	35'-10"	---	
D701	E	7	8	3'-0"	BENT	

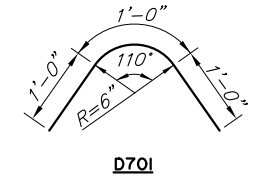
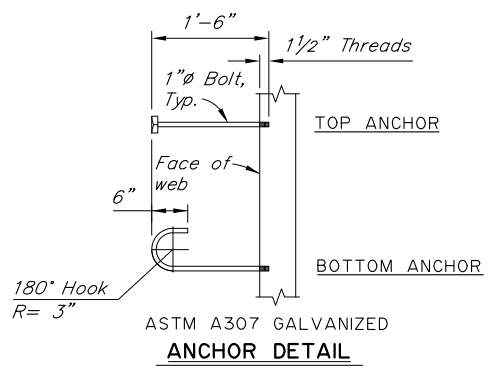
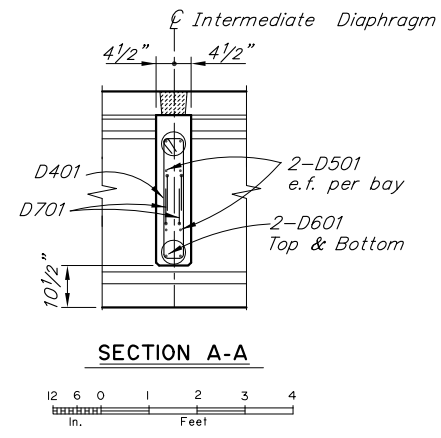
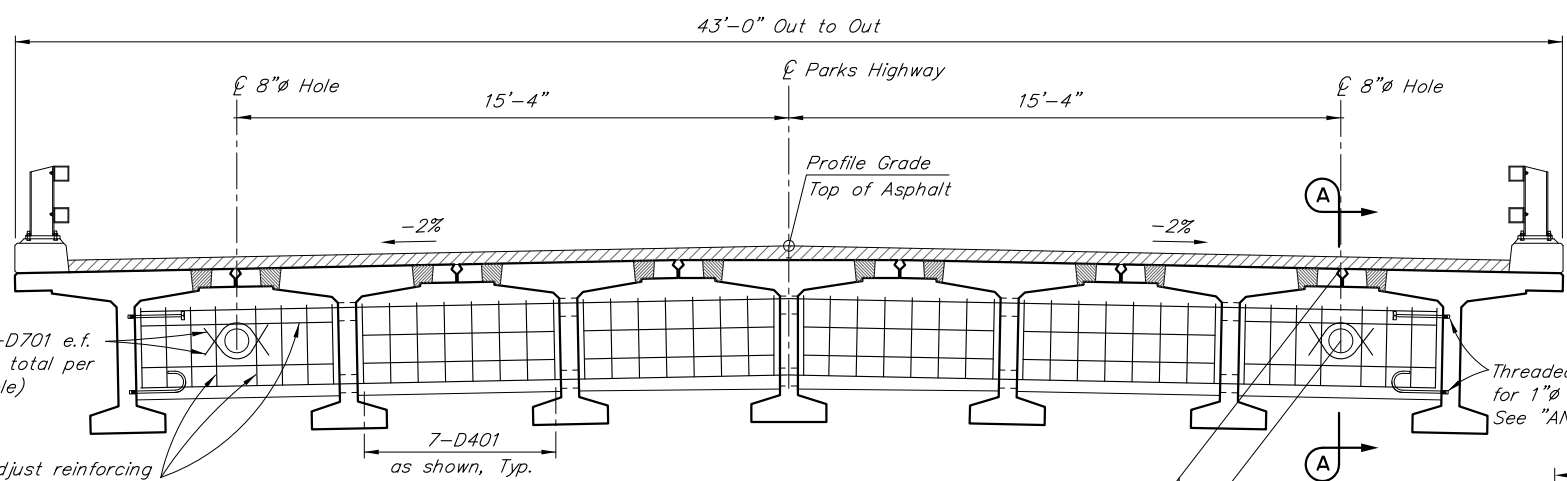

E - Epoxy-Coated  
M - Field adjust to match cross slope  
S - Splice permitted. Splice length not included

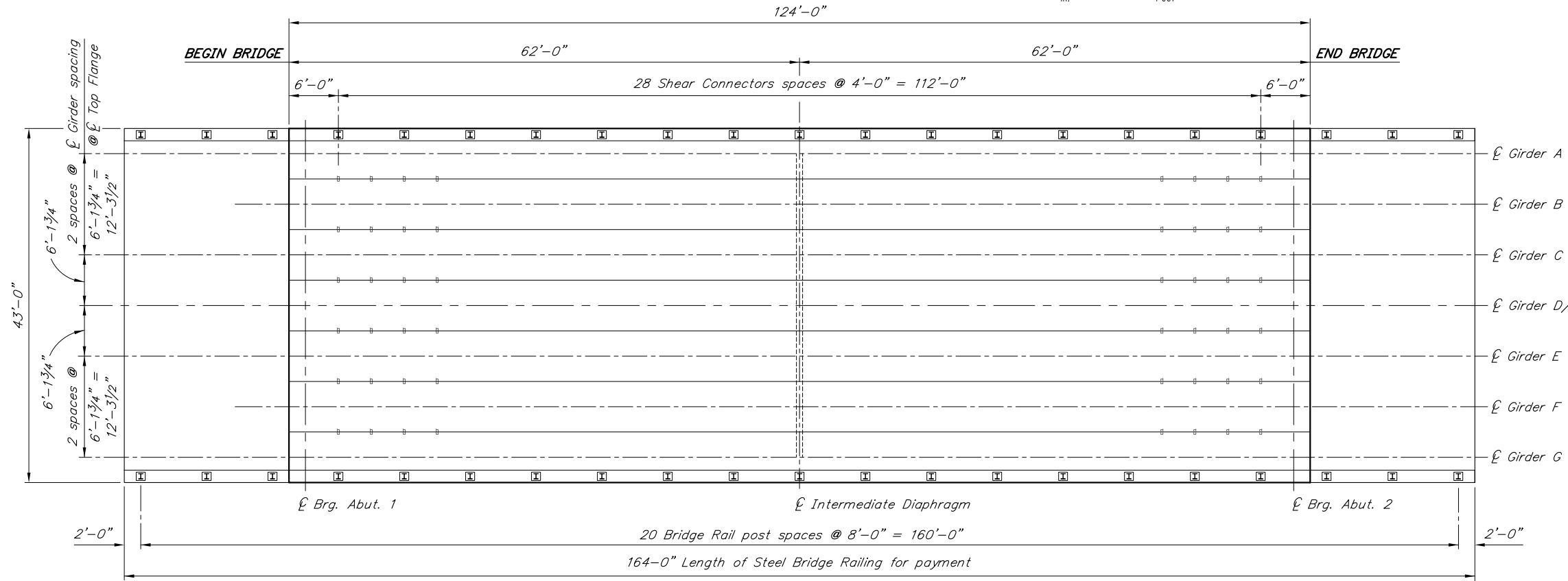

R:\cadd\678\678-1-TYPICAL SECTION Thu, Aug/29/19 02:36pm

DESIGNED BY:	Designer	CHECKED:	Checker
DRAWN BY:	Sam Sollie	CHECKED:	Designer
QUANTITIES BY:	Designer	CHECKED:	Checker

**PRELIMINARY PLAN**

STATE OF ALASKA  
DEPARTMENT OF TRANSPORTATION  
AND PUBLIC FACILITIES  
BRIDGE SECTION  
3132 Channel Drive  
Juneau, Alaska 99801  
907-465-2975

**LITTLE GOLDSTREAM BRIDGE**  
PARKS HIGHWAY  
FRAMING PLAN AND TYPICAL SECTION



BRIDGE NO. 678  
DWG. NO. 10

STATE	PROJECT DESIGNATION	YEAR	SHEET NO.	TOTAL SHEETS
ALASKA	Z606570000/OA45028	2019	N43	TtShTs

**REINFORCING STEEL - ONE GIRDER**

MARK	NOTE	SIZE	NO.	LENGTH	TYPE	BENDING DIAGRAM
G401	E	4	199	5'-10"	BENT	
G401X	E,X	4	232	5'-10"	BENT	
G402	E,S	4	10	116'-4"	---	
G402X	E,S,X	4	10	116'-4"	---	
G403	E	4	388	5'-8"	BENT	
G404	E	4	76	3'-3"	BENT	
G501	E	5	199	5'-8"	---	
G501X	E,X	5	232	6'-4"	BENT	
G502	E,S	5	10	123'-8"	BENT	
G502X	E,S,X	5	10	123'-8"	BENT	
G601	E	6	20	5'-8"	BENT	
C401	E,L,X	4	84	4'-9"	BENT	
C501	E,S,X	5	2	123'-8"	---	

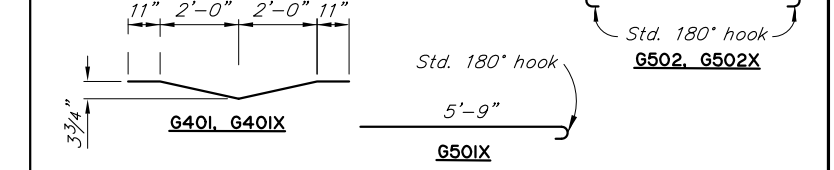

E - Epoxy-Coated  
L - Ship 6 loose for diaphragm, per exterior girder  
S - Length does not include splices. Minimum lap splice length for splices shall be 2'-0" for #4 bars and 2'-6" for #5 bars  
X - Exterior Girders only

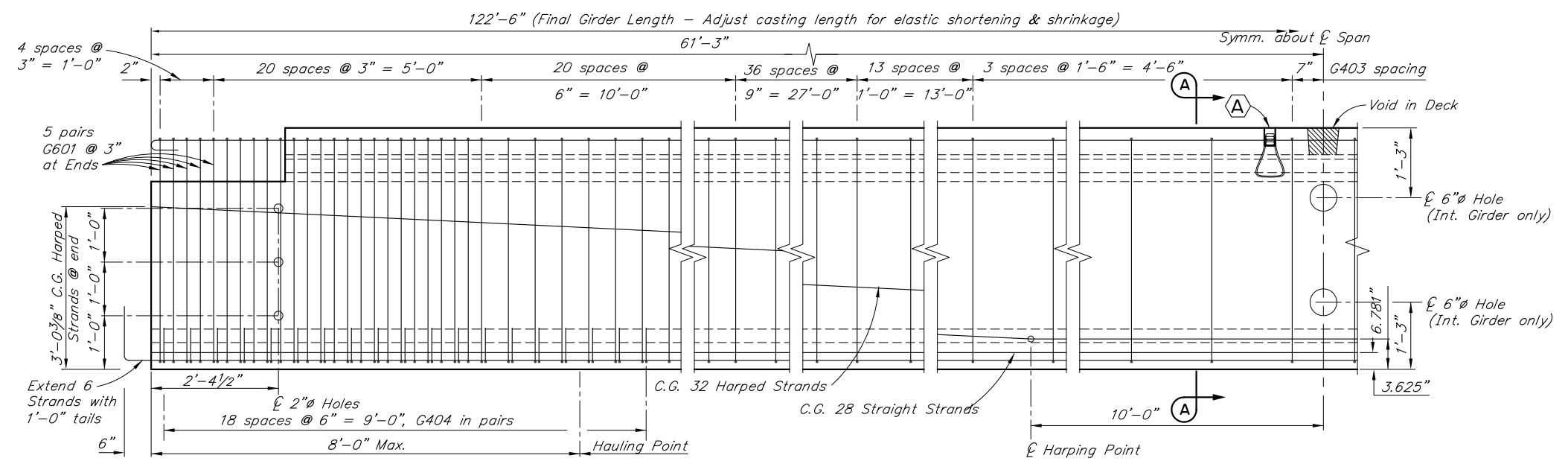

**ELEVATION**

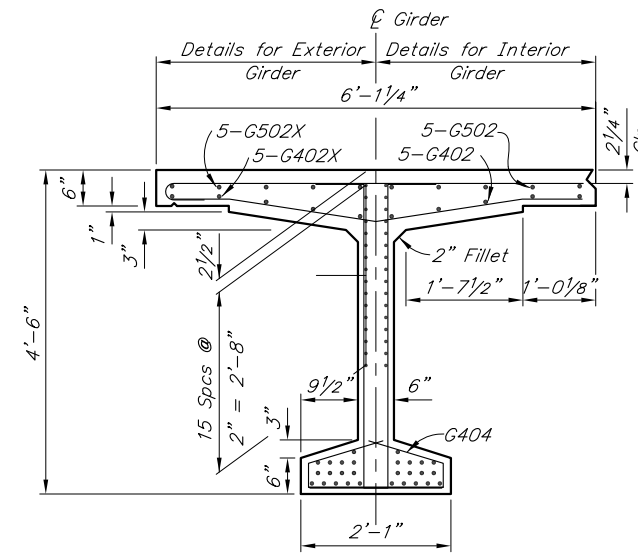
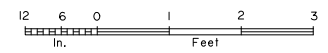

**END VIEW**

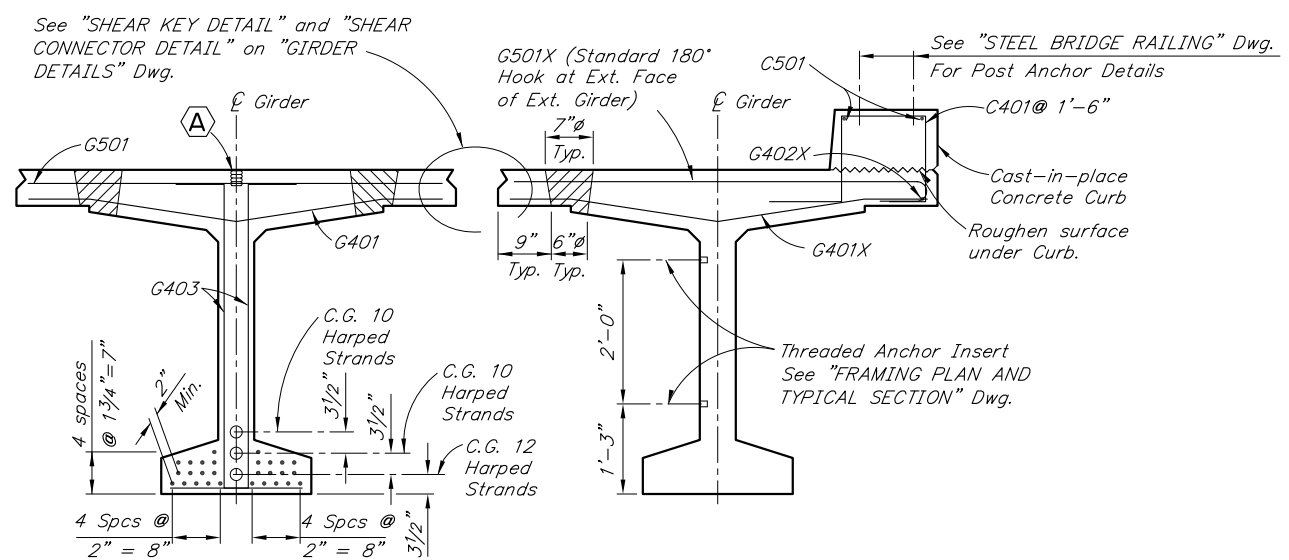

**SECTION A-A**

**EXTERIOR GIRDER NEAR MID SPAN**  
(Unrelated Reinforcement not shown)

**GIRDER NOTES:**

- Class P Concrete: at Stress Transfer.....f'ci = 6,500 psi  
at 28 Days.....f'c = 7,500 psi
- 1/2" low-relaxation prestressing strands with an ultimate strength of 270 ksi and a cross sectional area of 0.153 in<sup>2</sup>.
- Steel stresses: Pretensioning - Jacking Stress 189 ksi  
After initial losses 170 ksi  
After all losses 140 ksi
- One inch clear cover on reinforcing steel unless otherwise noted.
- See "FRAMING PLAN AND TYPICAL SECTION" Dwg. for Shear Connector spacing.
- Deflect forms to compensate for camber.
- Galvanize structural steel embedded in girders except for shear connectors.
- 1"X1'-0" Coil Anchor Insert for vertical adjustment of girders. Recess 2". Prevent concrete from filling hole.
- Omit Shear Key, Shear Key Connector and Deck Void in exterior face of exterior girders.
- Cast ends of girders plumb with respect to roadway grade. Install web holes and web anchor inserts parallel to C bearing.
- Finish top flange with light broom.

R:\cadd\678\678-1-GIRDERS Thu, Aug/29/19 02:36pm

DESIGNED BY: <i>Designer</i>	CHECKED: <i>Checker</i>
DRAWN BY: <i>Sam Sollie</i>	CHECKED: <i>Designer</i>
QUANTITIES BY: <i>Designer</i>	CHECKED: <i>Checker</i>

**PRELIMINARY PLAN**

STATE OF ALASKA  
**DEPARTMENT OF TRANSPORTATION  
AND PUBLIC FACILITIES**  
BRIDGE SECTION  
3132 Channel Drive  
Juneau, Alaska 99801  
907-465-2975

**LITTLE GOLDSTREAM BRIDGE**  
PARKS HIGHWAY  
**GIRDERS**



BRIDGE NO. 678  
DWG. NO. II

STATE	PROJECT DESIGNATION	YEAR	SHEET NO.	TOTAL SHEETS
ALASKA	Z606570000/OA45028	2019	N44	TtShts

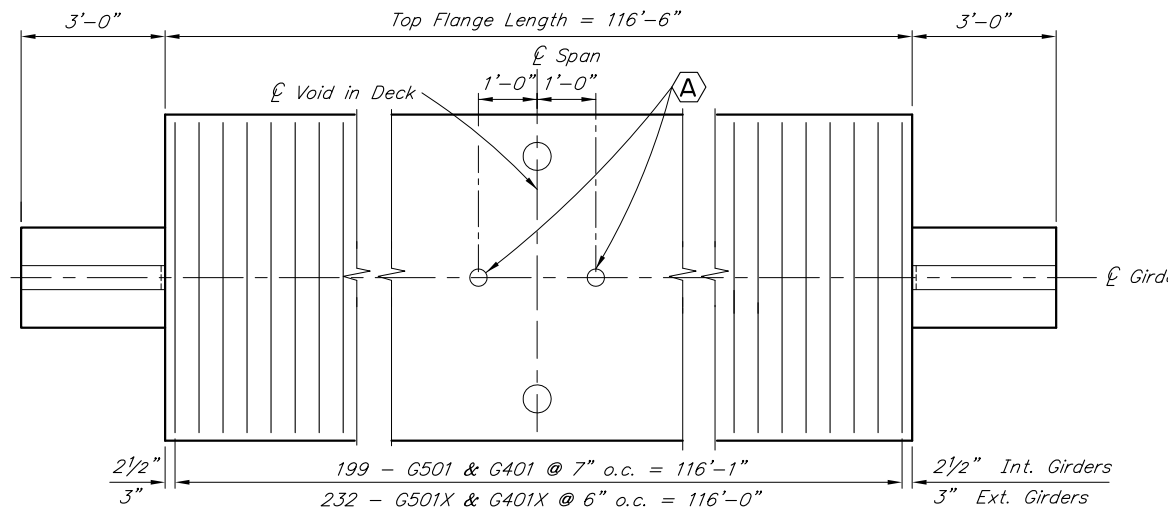

**PLAN**  
No Scale

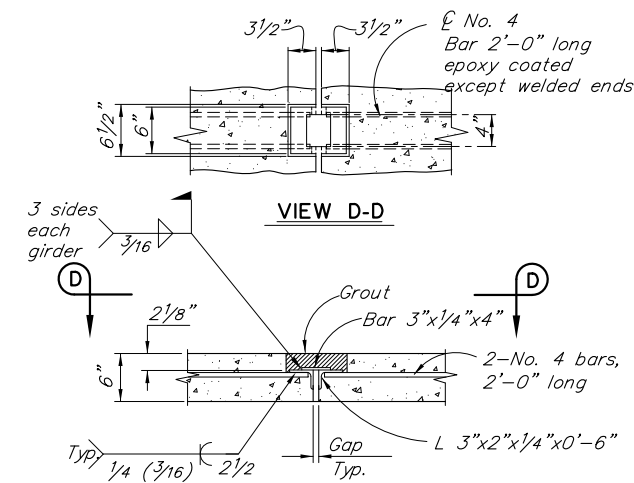

**SHEAR CONNECTOR DETAIL**

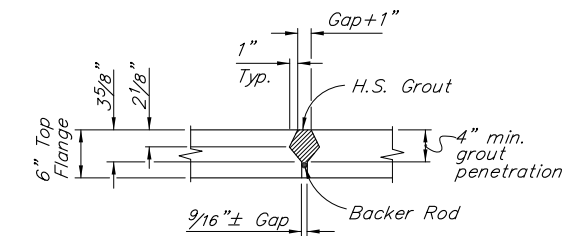

**SHEAR KEY DETAIL**



R:\cadd\678\678-1-GIRDERS (2) Thu, Aug/29/19 02:36pm

DESIGNED BY: <i>Designer</i>	CHECKED: <i>Checker</i>
DRAWN BY: <i>Sam Sollie</i>	CHECKED: <i>Designer</i>
QUANTITIES BY: <i>Designer</i>	CHECKED: <i>Checker</i>

**PRELIMINARY PLAN**

STATE OF ALASKA  
DEPARTMENT OF TRANSPORTATION  
AND PUBLIC FACILITIES  
BRIDGE SECTION  
3132 Channel Drive  
Juneau, Alaska 99801  
907-465-2975

**LITTLE GOLDSTREAM BRIDGE**  
PARKS HIGHWAY  
**GIRDER DETAILS**



BRIDGE NO. 678  
DWG. NO. 12

STATE	PROJECT DESIGNATION	YEAR	SHEET NO.	TOTAL SHEETS
ALASKA	Z606570000/OA45028	2019	N45	Tt1Shts

REINFORCING STEEL - ONE APPROACH SLAB						
MARK	NOTE	SIZE	NO.	LENGTH	TYPE	BENDING DIAGRAM
S401	E,M	4	62	39'-7"	---	
S501	E	5	80	20'-5"	---	
S502	E	5	40	5'-0"	BENT	
S801	E	8	80	20'-5"	---	

E - Epoxy-Coated  
M - Field adjust to match cross slope

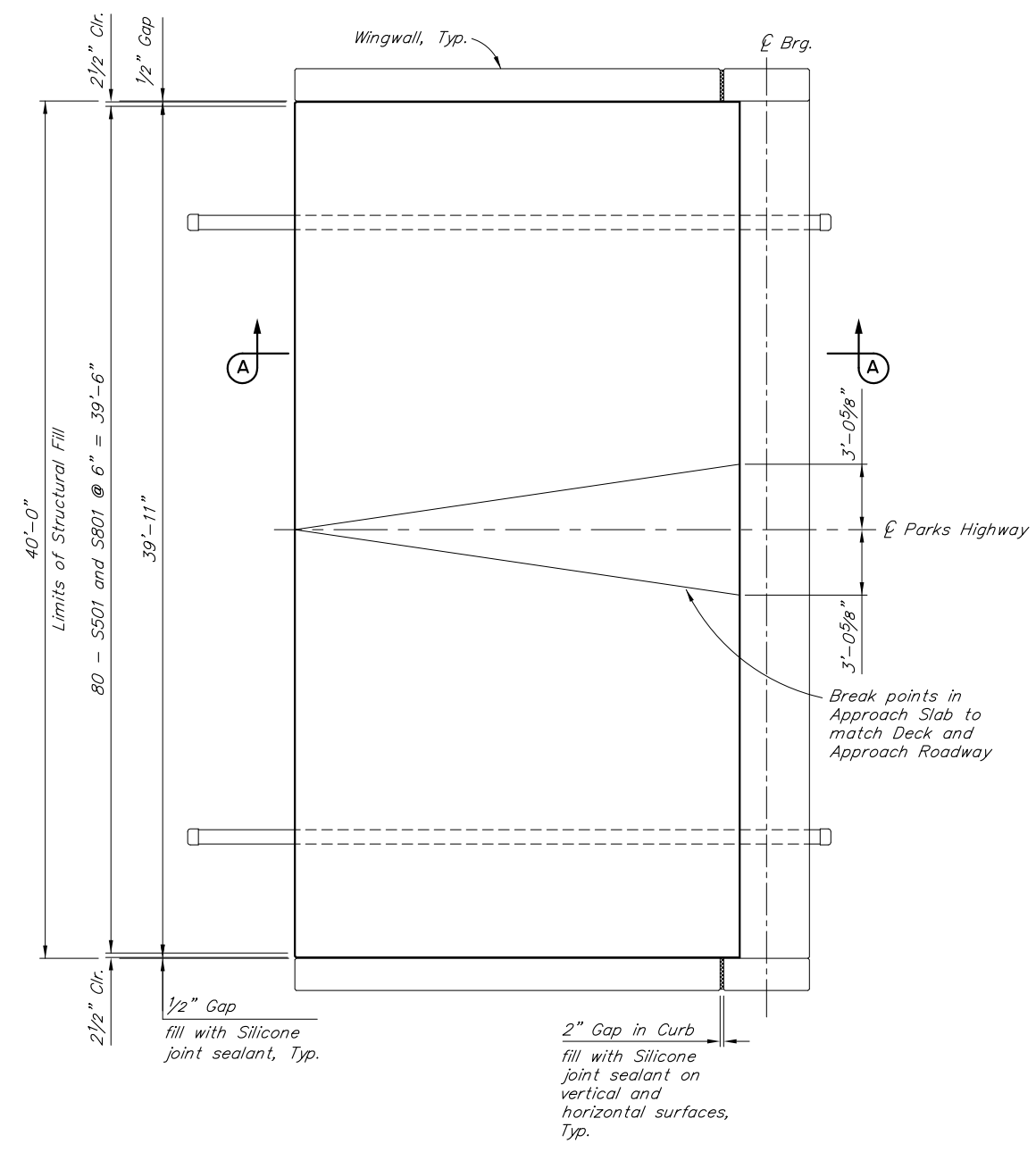

**PLAN**  
(Abutment 1 shown Abutment 2 similar)

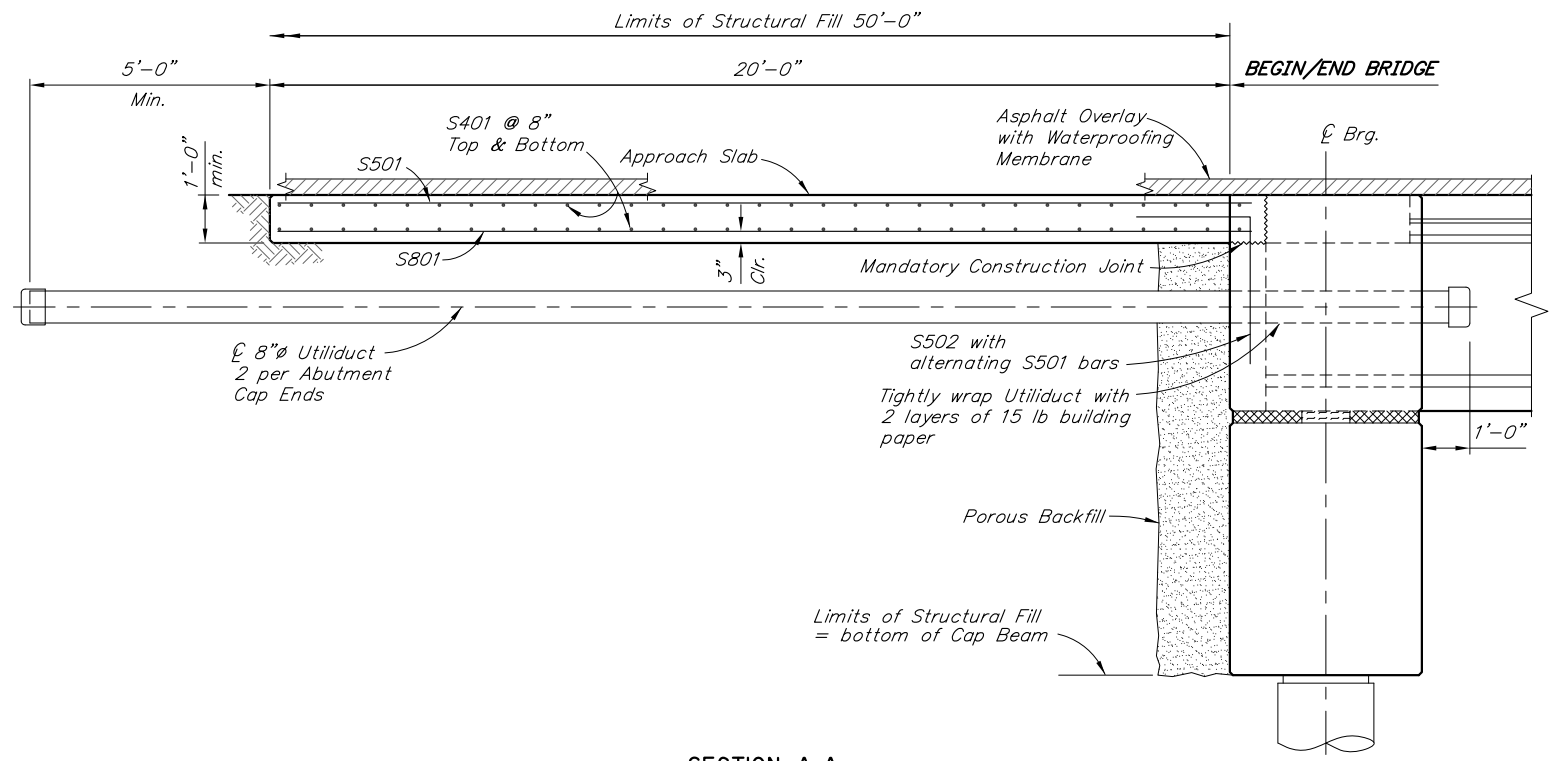

**SECTION A-A**

R:\cadd\678\678-1-APPROACH SLAB Thu, Aug/29/19 02:36pm

DESIGNED BY:	Designer	CHECKED:	Checker
DRAWN BY:	Sam Sollie	CHECKED:	Designer
QUANTITIES BY:	Designer	CHECKED:	Checker

**PRELIMINARY PLAN**

STATE OF ALASKA  
DEPARTMENT OF TRANSPORTATION  
AND PUBLIC FACILITIES  
BRIDGE SECTION  
3132 Channel Drive  
Juneau, Alaska 99801  
907-465-2975

**LITTLE GOLDSTREAM BRIDGE**  
PARKS HIGHWAY  
**APPROACH SLAB**

BRIDGE NO. 678  
DWG. NO. 13

STATE	PROJECT DESIGNATION	YEAR	SHEET NO.	TOTAL SHEETS
ALASKA	Z606570000/OA45028	2019	N46	TtSHts

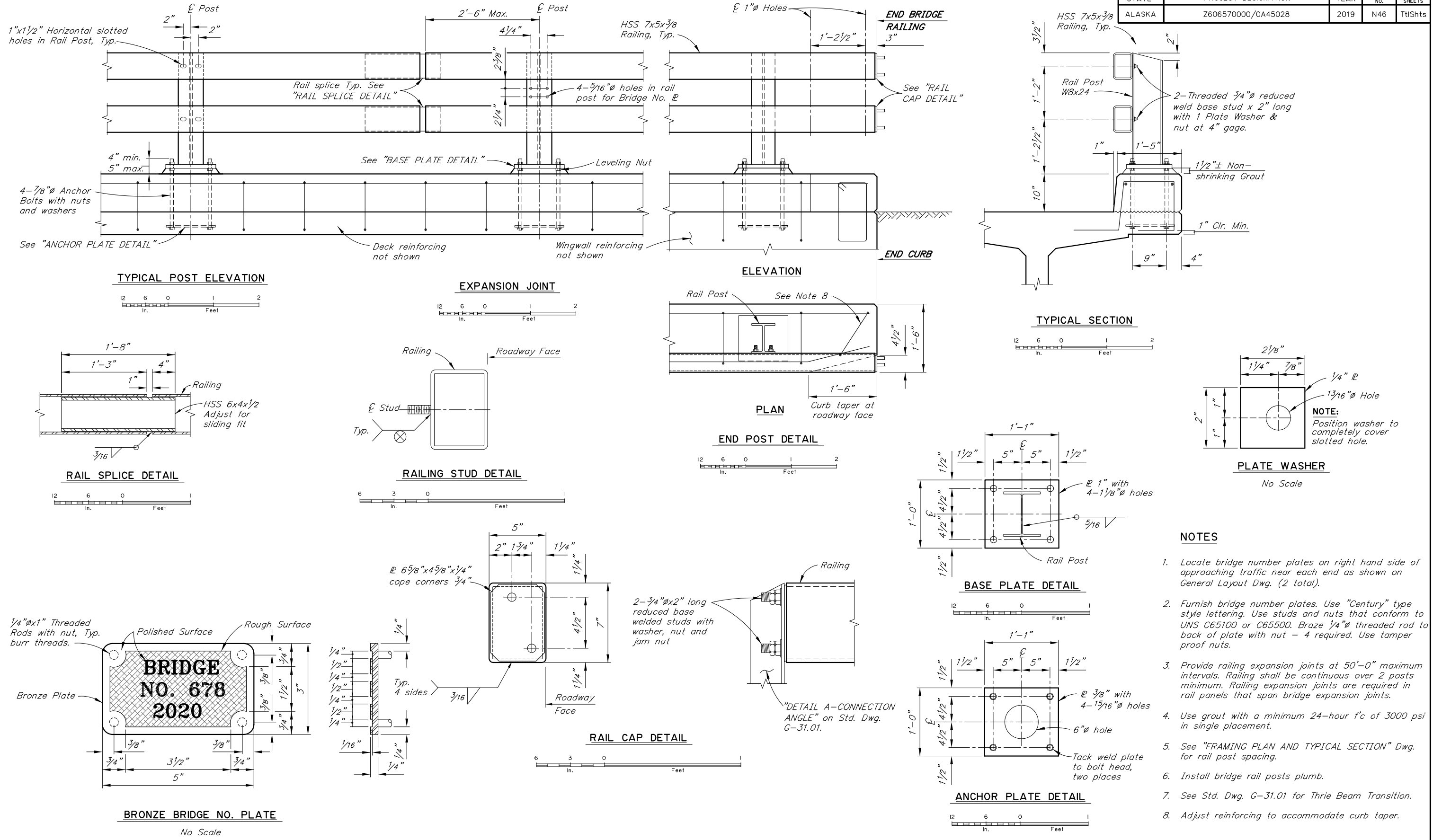

- NOTES**
1. Locate bridge number plates on right hand side of approaching traffic near each end as shown on General Layout Dwg. (2 total).
  2. Furnish bridge number plates. Use "Century" type style lettering. Use studs and nuts that conform to UNS C65100 or C65500. Braze 1/4" threaded rod to back of plate with nut - 4 required. Use tamper proof nuts.
  3. Provide railing expansion joints at 50'-0" maximum intervals. Railing shall be continuous over 2 posts minimum. Railing expansion joints are required in rail panels that span bridge expansion joints.
  4. Use grout with a minimum 24-hour f'c of 3000 psi in single placement.
  5. See "FRAMING PLAN AND TYPICAL SECTION" Dwg. for rail post spacing.
  6. Install bridge rail posts plumb.
  7. See Std. Dwg. G-31.01 for Thrie Beam Transition.
  8. Adjust reinforcing to accommodate curb taper.

DESIGNED BY:	Designer	CHECKED:	Checker
DRAWN BY:	Sam Sollie	CHECKED:	Designer
QUANTITIES BY:	Designer	CHECKED:	Checker

**PRELIMINARY PLAN**

STATE OF ALASKA  
 DEPARTMENT OF TRANSPORTATION  
 AND PUBLIC FACILITIES  
 BRIDGE SECTION  
 3132 Channel Drive  
 Juneau, Alaska 99801  
 907-465-2975

**LITTLE GOLDSTREAM BRIDGE**  
 PARKS HIGHWAY  
**STEEL BRIDGE RAILING, 2-TUBE**



BRIDGE NO. 678  
 DWG. NO. 14

R:\cadd\678\678-1-RAILING Thu, Aug/29/19 02:36pm



STATE	PROJECT DESIGNATION	YEAR	SHEET NO.	TOTAL SHEETS
ALASKA	Z606570000/OA45028	2019	N47	TtShts

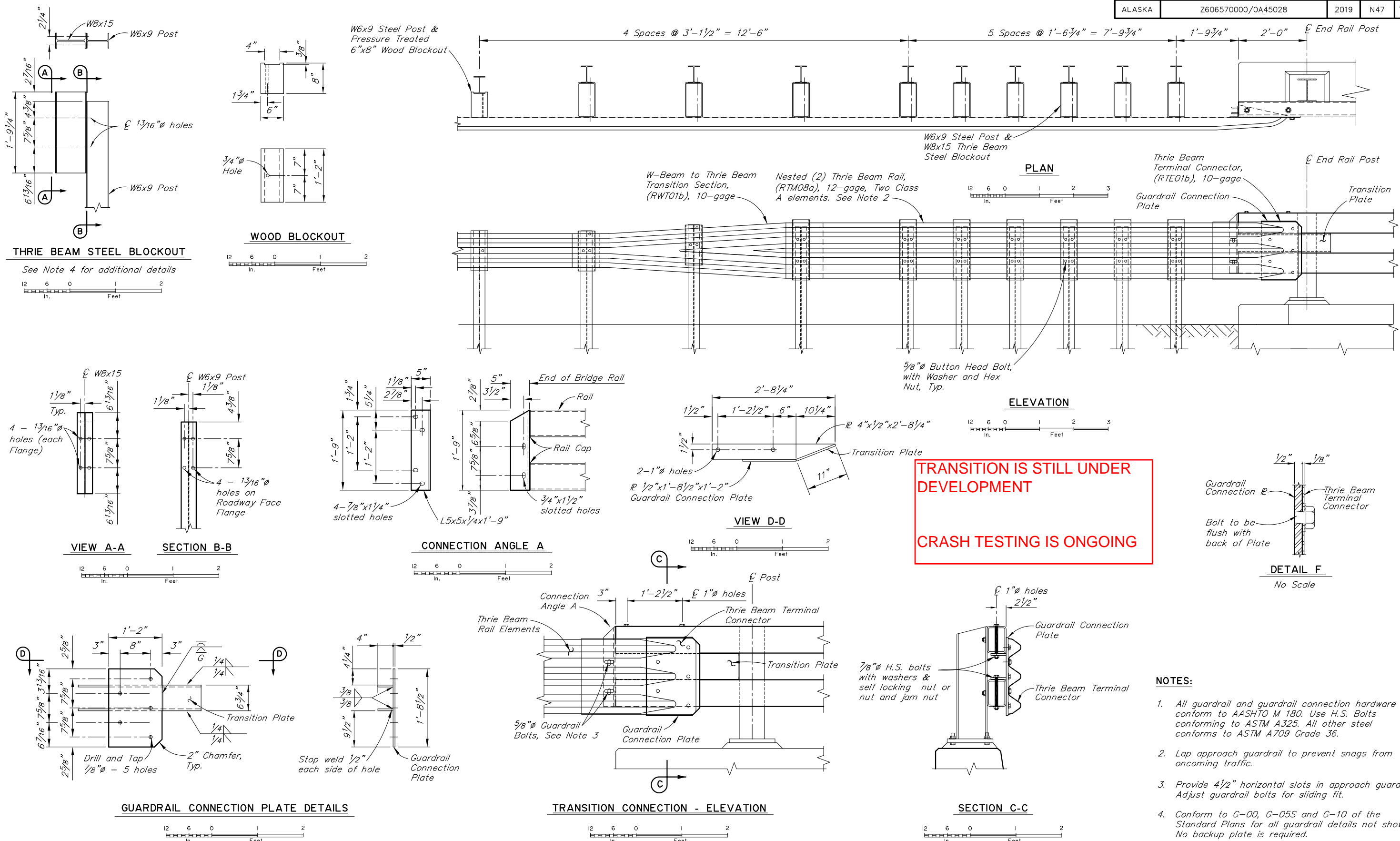

TRANSITION IS STILL UNDER DEVELOPMENT  
CRASH TESTING IS ONGOING

- NOTES:**
1. All guardrail and guardrail connection hardware to conform to AASHTO M 180. Use H.S. Bolts conforming to ASTM A325. All other steel conforms to ASTM A709 Grade 36.
  2. Lap approach guardrail to prevent snags from oncoming traffic.
  3. Provide 1/2" horizontal slots in approach guardrail. Adjust guardrail bolts for sliding fit.
  4. Conform to G-00, G-05S and G-10 of the Standard Plans for all guardrail details not shown. No backup plate is required.

R:\cadd\678\678-1-THRIE BEAM Thu, Aug/29/19 02:36pm

DESIGNED BY:	Designer	CHECKED:	Checker
DRAWN BY:	Sam Sollie	CHECKED:	Designer
QUANTITIES BY:	Designer	CHECKED:	Checker

PRELIMINARY PLAN

STATE OF ALASKA  
DEPARTMENT OF TRANSPORTATION  
AND PUBLIC FACILITIES  
BRIDGE SECTION  
3132 Channel Drive  
Juneau, Alaska 99801  
907-465-2975

LITTLE GOLDSTREAM BRIDGE  
PARKS HIGHWAY  
THRIE BEAM TRANSITION, 2-TUBE

  
BRIDGE NO. 678  
DWG. NO. 15

**Appendix G**

**DESIGN EXCEPTION AND DESIGN WAIVER REQUEST**

## **ALASKA DOT&PF PRECONSTRUCTION DESIGN EXCEPTION/DESIGN WAIVER**

The Alaska Department of Transportation and Public Facilities plans to reconstruct approximately 20 miles of the Parks Highway from milepost (MP) 305 to 325 to enhance safety and accommodations for motorized and non-motorized traffic along the corridor. Improvements will include standardizing horizontal and vertical curvature, minimizing grades, removing the seasonal load limits, optimizing and adding passing lanes and replacing the Little Goldstream Bridge No. 678. The new bridge will provide 8-ft shoulders to improve safety by reducing conflict. This project is expected to be constructed in five segments.

Areas of the corridor were reviewed for design exceptions based on the Federal Highway Administration's (FHWA's) 10 controlling criteria that require approved design exceptions if they do not meet the minimum design standards as established by the Alaska Highway Preconstruction Manual (PCM). The 10 criteria include: design speed, lane width, shoulder width, cross slope, superelevation rate, horizontal alignment (minimum radius of curvature), grade, stopping sight distance, vertical clearance and bridge structural capacity. Design waivers are required for any other design criteria that do not meet the PCM established standards.

Two design exceptions for stopping sight distance and three design waivers for vertical curves are requested for this project. These are located near the beginning of project, from Sta 1395+00 (MP 325) to Sta 1455+00 (MP 323.5). The design exceptions and design waivers area have multiple vertical curves in close proximity, meaning one curve cannot be flattened without impacting the others. Therefore, the design exception area must be evaluated as a whole and not as individual components.

The requested design exceptions and design waivers do not meet current design standards: however, an effort has been made to improve upon existing conditions. Even though full design standards are not met, the cumulative impact of the project will enhance safety and function of the highway. Detailed design may provide additional improvement opportunities.

### **PROJECT INFORMATION:**

**Project Name:** Parks Highway MP 305 to 325 Reconstruction

**Project Number:** 0A45028/Z606570000

NHS    Non NHS

This project is requesting:

Design Exception (FHWA controlling design criteria only)

Design Waiver (all other design criteria)

Table 1: Design Criteria

Design Year:	2040	Functional Classification:	Principal Arterial
Present ADT:	1,800	Equivalent Axle Loading:	1,530,697
Design Year ADT:	2,430	Pavement Design Year:	2040
Mid Design Period:	2,140	Design Vehicle:	WB-40
DHV:	14.50%	Terrain:	Mountainous (MP 315-325) Level (305-315)
Directional Split:	35/65	Number of Roadways:	1
Percent Trucks:	17%	Design Speed:	70 mph



## 1. Challenges

As the Parks Highway climbs the Nenana Hills multiple vertical curves exist along the mountainous terrain. The existing alignment from MP 323.5 to 325 contains closely spaced vertical curves separated by short tangents, see Figure 1. This combination is not conducive to flatter vertical geometry without significantly increasing earthwork resulting in added cost in earthwork and multiple lane shifts to bring the road to current standards resulting in a higher cost for maintenance of traffic during construction.

Table 2 summarizes the vertical curves and stopping sight distance from Sta 1395+00 to 1455+00, which require a design exception or waiver.

STATE	PROJECT DESIGNATION	YEAR	SHEET NO.	TOTAL SHEETS
ALASKA	0A45028/Z606570000	2025	1	1

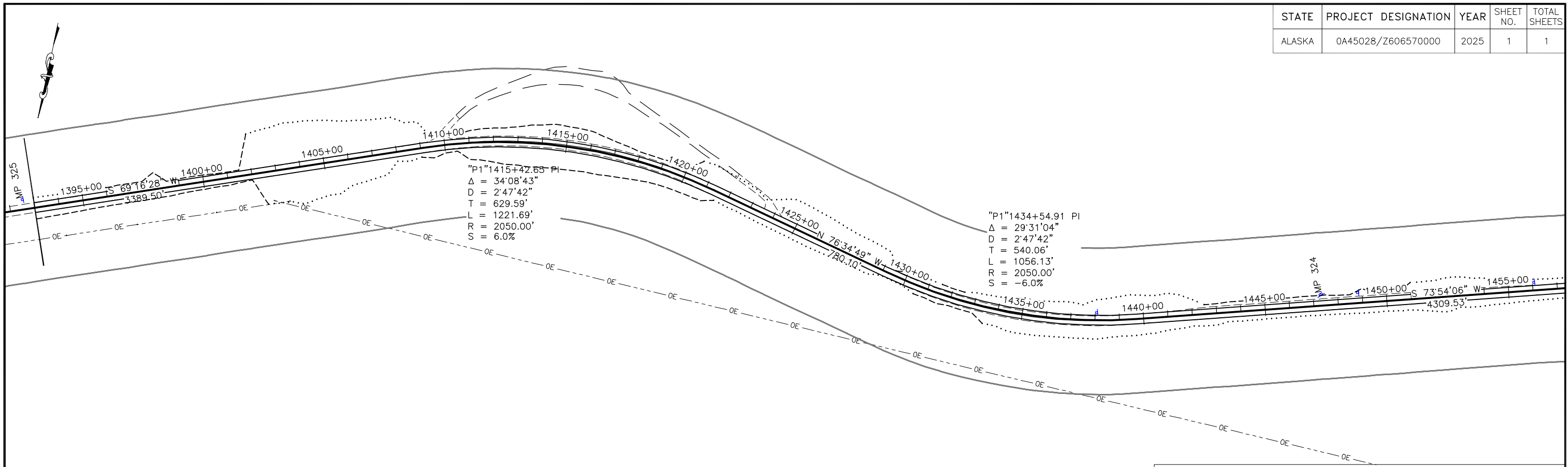
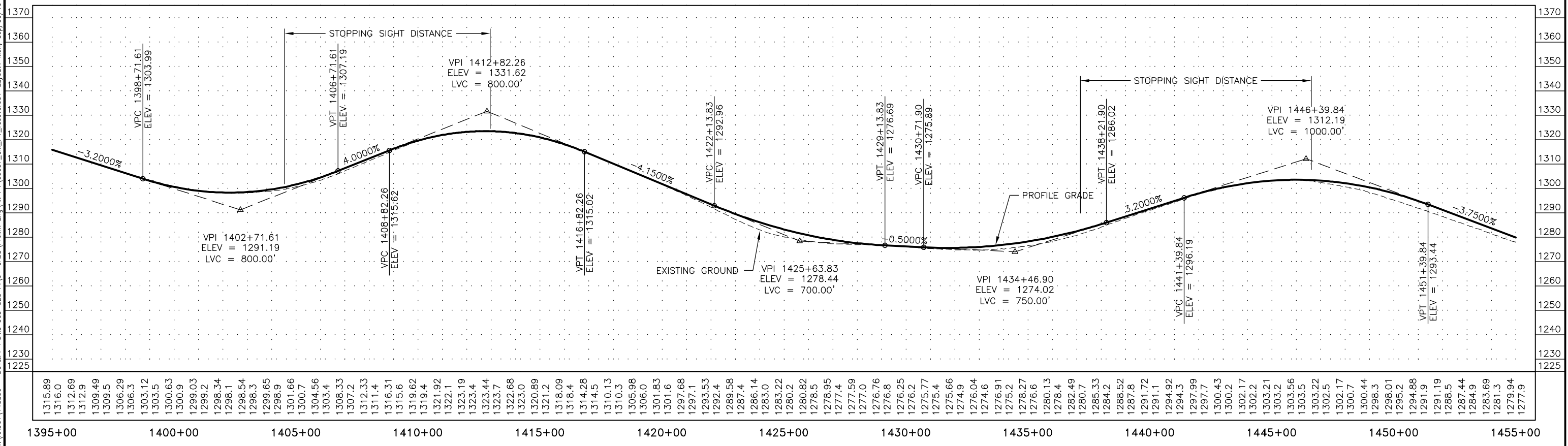

FIGURE 1  
PROPOSED DESIGN STA 1395+00 TO STA 1455+00

T:\AK001\148830 - DOT&PF Parks 305-325 P\04 CAD\0 Prelim Eng\Alt P1\60657\_CM\_P1\_recover001-Layout1 Mon, Sep/30/19 04:54pm



1315.89	1316.0	1312.69	1312.9	1309.49	1309.5	1306.29	1306.5	1303.12	1303.5	1300.63	1300.9	1299.03	1299.2	1298.34	1298.1	1298.54	1298.3	1298.65	1298.9	1301.66	1300.7	1304.56	1303.4	1308.33	1307.2	1312.33	1311.4	1316.31	1315.6	1319.62	1319.4	1321.92	1322.1	1323.19	1323.4	1323.44	1323.7	1322.68	1323.0	1320.89	1321.2	1318.09	1318.4	1314.28	1314.5	1310.13	1310.3	1305.98	1306.0	1301.83	1301.6	1297.68	1297.1	1293.53	1292.4	1289.58	1287.4	1286.14	1283.0	1283.22	1280.2	1280.82	1278.5	1278.95	1277.4	1277.59	1277.0	1276.76	1276.8	1276.25	1276.2	1275.77	1275.4	1275.66	1274.9	1276.04	1274.6	1276.91	1275.2	1278.27	1276.6	1280.13	1278.4	1282.49	1280.7	1285.33	1284.2	1288.52	1287.8	1291.72	1291.1	1294.92	1294.3	1297.99	1297.7	1300.43	1300.2	1302.17	1302.2	1303.21	1303.2	1303.56	1303.5	1303.22	1303.5	1300.44	1298.3	1298.01	1295.2	1294.88	1291.9	1291.19	1288.5	1287.44	1284.9	1283.69	1281.3	1279.94	1277.9
---------	--------	---------	--------	---------	--------	---------	--------	---------	--------	---------	--------	---------	--------	---------	--------	---------	--------	---------	--------	---------	--------	---------	--------	---------	--------	---------	--------	---------	--------	---------	--------	---------	--------	---------	--------	---------	--------	---------	--------	---------	--------	---------	--------	---------	--------	---------	--------	---------	--------	---------	--------	---------	--------	---------	--------	---------	--------	---------	--------	---------	--------	---------	--------	---------	--------	---------	--------	---------	--------	---------	--------	---------	--------	---------	--------	---------	--------	---------	--------	---------	--------	---------	--------	---------	--------	---------	--------	---------	--------	---------	--------	---------	--------	---------	--------	---------	--------	---------	--------	---------	--------	---------	--------	---------	--------	---------	--------	---------	--------	---------	--------	---------	--------	---------	--------	---------	--------	---------	--------

Table 2: Design Exception/Design Waiver Summary

Design Exception /Design Waiver	Location (proposed station range)	Criteria	Standard Value	Existing Value	Proposed Value	Grade In	Grade Out
Waiver	Sta 1398+72 to 1406+72	Vertical Alignment (Sag Curve)	K=181 (AASHTO 2011 GB Table 3-36 page 3-161)	106	111	-3.15%	4.02%
Waiver	Sta 1408+82 to 1416+82	Vertical Alignment (Crest Curve)	K=247 (AASHTO 2011 GB Table 3-34 page 3-155)	92	98	4.02%	-4.53%
Exception	Sta 1405+30 to 1413+70	Stopping Sight Distance	730 feet (AASHTO 2011 GB Table 3-34 page 3-155)	460	470		
Waiver	Sta 1441+40 to 1451+40	Vertical Alignment (Crest Curve)	K=247 (AASHTO 2011 GB Table 3-34 page 3-155)	113	144	3.49%	-3.48%
Exception	Sta 1438+00 to 1447+40	Stopping Sight Distance	730 feet (AASHTO 2011 GB Table 3-34 page 3-155)	500	570		

**2. Design Exception(s)/Design Wavier(s)**

The Design Exceptions proposed are for stopping sight distance at two locations where minimum standards are not met. The crest curves cannot be flattened to meeting design standards for sight distance without impacting the sag curves in close proximity.

The Design Waivers proposed are for Vertical Alignment (Crest and Sag Curves) at three locations where K values do not meet current design standards. Each of these will be improved, but not to design standards.

**3. Existing Roadway Characteristics**

The terrain varies from level to mountainous through the project. The area of the design exceptions and waivers is in mountainous terrain within the Nenana Hills. Vegetation in the area is predominantly black spruce and birch.

Traffic in this area is a mix of commercial, tourist, and commuter. The current posted speed is 65-mph, with multiple curves below the minimum standards. The design features for this project are based on a 70-mph design speed, which is consistent with the 65-mph posted speed and interstate standards.



#### **4. Safety and Operational Performance**

Existing crash data, from 2010 to 2014, identified only one crash occurring near the proposed design exception location at Sta 1380+00 (just north of the project limits). The crash involved a single vehicle colliding with the guardrail face, resulting in property damage only. The calculated crash rate, for the design exception area is 0.2 crashes/million vehicle miles (mvm), while the statewide average crash rate for 2-lane rural roads is 2.3 crashes/mvm; flattening the vertical curves, in this area is not justifiable. The proposed design will maintain the existing vertical profile between Sta 1395+00 to Sta 1455+00; however, the existing pull off will be removed to eliminate conflict points along this segment and reduce future crash rates.

#### **5. Right-of-way**

The right-of-way along the Parks Highway between MP 323.5 and 325 is between 300 and 570 ft. Acquisition of additional 0.15 acres of right-of-way is required for the design to meet standards, would be through Toghettele. However, the proposed design exception construction area is within the existing right-of-way.

#### **6. Environmental Impacts**

Environmental impacts are minimal for the proposed design. Every effort will be made to limit environmental impacts and provide mitigation measures where opportunities are available.

#### **7. Compatibility with adjacent sections of roadway**

The project is considered to have rolling to mountainous terrain. Users expect to encounter sharp horizontal and vertical curves, limited sight distance, and steep grades in this terrain. The design exception area does not pose an unexpected condition to road users. The design exception area will include appropriate signing and should feel similar to adjacent section of the roadway.

#### **8. Usability of All Modes of Transportation**

Project improvements, and approval of design exceptions, will not reduce the usability of the highway for any mode of transportation. The improvements will enhance usability even though full design standards are not met.

#### **9. Mitigation Strategies**

*Proposed Mitigation:* The proposed design exceptions and design waivers will not affect other standards. The proposed design will slightly improve the stopping sight distance and K values. Signing will be used to alert vehicles to sharp crest curves following the guidelines in the Alaska Traffic Manual.

*Design to Standards:* In order for MP 323.5 to 325 to meet current design standards the profile requires complete renovation, changing the profile elevation 5 to 12 ft and eliminating a sag curve

that meets design standards. The profile change requires excavating 150,000 cubic yards, along the existing roadway corridor, which will require additional lane shifts during construction to maintain traffic while safely moving the material to adjust the profile. A large portion of the excavation will coincide with a crest curve that is in an existing cut approximately 25 ft below surround topography.

**10. Cost Estimate**

Rough order of magnitude cost estimate for the two strategies are presented in the table below. The cost difference between the strategies is in the extra 100,000 CY of excavation and the cost of traffic maintenance. The structural section will be equal between the strategies.

	Proposed Design	Design to Standards
<b>Approximate Construction Earthwork Requirements (CY)</b>	45,000	150,000
<b>Approximate Maintenance of Traffic</b>	\$250,000	\$750,000
<b>Approximate Total Construction Cost</b>	\$3,360,000	\$4,710,000

With the requested design exceptions and design waivers, the proposed design improves upon existing roadway design and safety issues while keeping in mind the terrain and use of highway. The remainder of the Parks Highway MP 305 to 325 Reconstruction Project will be meet design standards. Based on the crash data within the design exception area and the extent of earthwork on alignment required to bring the vertical curves to current design standards approval of the proposed design exceptions and design waivers is recommended.

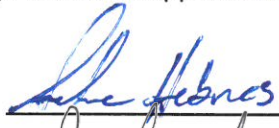
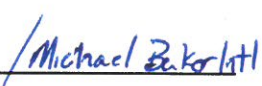
Proposed – Designer/Consultant:  /  Date: 12.16.19

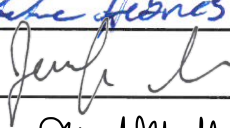
Endorsed – Engineering Manager:  Date: 12/16/19

Approved – Preconstruction Engineer:  Date: 1/29/2020

Concur – FHWA: \_\_\_\_\_ Date: \_\_\_\_\_

*FHWA concurrence required for high profile projects only.*

**Appendix H**  
**REFERENCED REPORTS**

# Memorandum

## Alternatives Analysis Methodology

---

**Project:** Parks Highway Milepost 305-325 Reconstruction  
**Subject:** Alternatives Analysis Methodology  
**To:** Lauren Little, P.E., DOT&PF Project Manager  
**From:** Derek Christianson, P.E., Michael Baker Project Manager  
**Date:** December 27, 2017

---

1	Introduction .....	A.1
2	Methodology.....	A.1
3	Conclusion.....	A.2

---

## 1 Introduction

This memorandum summarizes the process used to evaluate and select a design alternative for the Parks Highway Milepost (MP) 305 to 325 project. The project goals are to:

- Improve safety
- Improve geometry to meet current standards
- Eliminate seasonal load restrictions
- Improve existing and create additional passing opportunities
- Enhance commercial and recreational function

Four design alternatives were developed as described below.

- **P1.** This alternative meets 70mph design standards with a primary focus on maximizing geometric improvements. Constructability and earthwork considerations were secondary.
- **P1\_6%.** This is the same as P1, except it allows for 6% maximum vertical grade instead of a 5%.
- **P2.** This alternative meets 70mph design standards with a primary focus on optimizing constructability and earthwork considerations.
- **P2\_6%.** This is the same as P2, except it allows for 6% maximum vertical grade instead of a 5%.

These design alternatives were discussed at length during a design charrette held on November 2-3, 2017. Attendees at the charrette included DOT&PF design, construction, maintenance, right-of-way and environmental staff, a representative from Toghottthele Corporation and Michael Baker International design staff.

## 2 Methodology

A matrix was developed to compare features of the two design alternatives with the no-build scenario. The matrix includes nine evaluation criteria as listed below.

- Traffic Operations
- Safety
- Utility Impacts
- Environmental Impacts
- Freight Operations

# Memorandum

## Alternatives Analysis Methodology

---

- Right-Of-Way (ROW) Impacts
- Constructability and Traffic Control
- Construction Cost
- Maintenance Considerations

Each evaluation criterion was given a weight to reflect its relative importance to the project. Each alternative was given a score from -2 (much worse) to +2 (much better) to capture how it compared to the no-build scenario. The total score for each alternative was determined by summing the product of each criterion score and weight. The matrix is included as Appendix 1 and a description of the criteria ratings is included as Appendix 2.

### **3 Conclusion**

Alternative P1 which maximizes geometric improvements and had the highest total matrix score is the recommended alternative.

*Appendix A Evaluation Matrix*



# Memorandum

## Alternatives Analysis Methodology

Parks Highway MP 305 - 325 Reconstruction: Alternative Evaluation Matrix										
Criteria & Weight	Traffic Operations	Safety	Utility Impacts	Environmental Impacts	Freight Operations	ROW Impacts	Constructability & Traffic Control	Construction Cost	Maintenance	Total Score
Alternative	20	20	5	5	5	5	10	10	20	
No Build	0	0	0	0	0	0	0	0	0	0
P1	2	2	-1	0	2	-2	-2	-2	2	38
P1_6%	1.5	2	-1	0	1.5	-2	-2	-1.5	2	34
P2	1.5	-1	-1	0	1.5	-1	-1	-1	2	14
P2_6%	1	-1	-1	0	1	-1	-1	-1	2	8

Rating Legend	
Effect on Criteria compared with Baseline Condition	
Much Better	2
Better	1
Same	0
Worse	-1
Much Worse	-2

# Memorandum

## Alternatives Analysis Methodology

---

### *Appendix B*

### *Evaluation Criteria Ratings*

# Memorandum

## Alternatives Analysis Methodology

The evaluation criteria and a description and score for each alternative are described below.

### Traffic Operations

Considers the ability to improve traffic flow through the corridor for cars, recreational vehicles (RV) and trucks. This is primarily measured by the average travel speed (ATS) and percent time spent following (PTSF) as determined by the Interactive Highway Safety Design Model (IHSDM) software.

Alternative	Description	Score
P1	Has the highest overall ATS values and lowest overall PTSF values. In addition, the continuous horizontal curve and 5% maximum grade near MP 321 was deemed most desirable for traffic operations during the design charrette.	2
P1_6%	Less desirable ATS and PTSF values. 6% grades are less desirable for truck or RV traffic.	1.5
P2	Less desirable ATS and PTSF values. The horizontal curves separated by a tangent near MP 321 was deemed least desirable for traffic operations during the design charrette.	1
P2_6%	Less desirable ATS and PTSF values and 6% grades are less desirable for truck or RV traffic.	1

### Safety.

Considers the estimated safety performance measured by the predicted crash rate as determined by the IHSDM software.

Alternative	Description	Score
P1	Shares the lowest overall predicted crash rate with P1_6%.	2
P1_6%	Shares the lowest overall predicted crash rate with P1.	2
P2	Has an overall predicted crash rate that is higher than the no-build scenario.	1
P2_6%	Has an overall predicted crash rate that is higher than the no-build scenario.	1

### Utility Impacts.

Considers the nature and extent of impacts to existing utilities.

Alternative	Description	Score
P1	All utility impacts are assumed to be equal among alternatives.	-1
P1_6%	All utility impacts are assumed to be equal among alternatives.	-1
P2	All utility impacts are assumed to be equal among alternatives.	-1
P2_6%	All utility impacts are assumed to be equal among alternatives.	-1

# Memorandum

## Alternatives Analysis Methodology

### Environmental Impacts.

Considers the nature and extent of impacts to the natural environment.

Alternative	Description	Score
P1	While this alternative has the largest footprint, the overall impacts are minimal. Additionally, the improvements will minimize the long-term impacts from users through more efficient travel and reduced crash rate.	0
P1_6%	While this alternative has the second largest footprint, the overall impacts are minimal. Additionally, the improvements will minimize the long-term impacts from users through more efficient travel and reduced crash rate.	0
P2	This alternative has a smaller footprint and the overall impacts are minimal. Additionally, the improvements will minimize the long-term impacts from users through more efficient travel and reduced crash rate.	0
P2_6%	This alternative has the smallest footprint and the overall impacts are minimal. Additionally, the improvements will minimize the long-term impacts from users through more efficient travel and reduced crash rate.	0

### Freight Operations.

Considers the ability to improve traffic operations for commercial freight traffic.

Alternative	Description	Score
P1	Has the highest traffic operations performance, which includes freight traffic. In addition, the continuous horizontal curve and 5% maximum grade near MP 321 was deemed most desirable for freight operations during the design charrette.	2
P1_6%	Less desirable traffic operations performance. 6% grades are less desirable for truck or RV traffic.	2
P2	Less desirable traffic operations performance. The horizontal curves separated by a tangent near MP 321 was deemed least desirable for traffic operations during the design charrette.	1
P2_6%	Less desirable traffic operations performance. 6% grades are less desirable for truck or RV traffic.	1

### Right-Of-Way Impacts.

Considers the extent of impacts to parcels beyond the highway ROW.

Alternative	Description	Score
P1	Has the largest footprint and greatest need for additional ROW.	-2
P1_6%	Has footprint slightly smaller than P1.	-2
P2	Has footprint slightly bigger than P1_6%.	-1
P2_6%	Has the smallest footprint and smallest need for additional ROW.	-1

# Memorandum

## Alternatives Analysis Methodology

### Constructability and Traffic Control.

Considers how easily each alternative can be built and how easily traffic can be maintained.

Alternative	Description	Score
P1	Will be most difficult to construct due to large footprint, deep through cuts, substantial vertical differences between existing and proposed grade and several locations where the new alignment overlaps the existing alignment preventing off-line construction.	-2
P1_6%	Like P1, though the footprint is slightly smaller and cuts are not as deep.	-2
P2	Designed to allow for easier construction access and maintenance of traffic. This alternative still has a fairly large footprint with some deep cuts, though not to the same degree as P1.	-1
P2_6%	Like P2, though the footprint is slightly smaller and cuts are not as deep.	-1

### Construction Cost.

Considers the estimated construction cost of each alternative.

Alternative	Description	Score
P1	The highest cost alternative with an estimated construction cost of \$92M.	-2
P1_6%	The second highest cost alternative with an estimated construction cost of \$84M.	-1.5
P2	The lowest cost alternative with an estimated construction cost of \$66M.	-1
P2_6%	The lowest cost alternative with an estimated construction cost of \$66M.	-1

### Maintenance.

Considers the reduction in maintenance burden for the state.

Alternative	Description	Score
P1	All alternatives are assumed to substantially reduce the maintenance burden.	2
P1_6%	All alternatives are assumed to substantially reduce the maintenance burden.	2
P2	All alternatives are assumed to substantially reduce the maintenance burden.	2
P2_6%	All alternatives are assumed to substantially reduce the maintenance burden.	2

# Draft Traffic and Safety Report

Parks Highway MP 305-325 Reconstruction  
DOT&PF/Federal Project No. Z606570000/0A45028

Prepared for:



Northern Region  
Alaska Department of  
Transportation and  
Public Facilities  
2301 Peger Road  
Fairbanks, AK 99709

Prepared by:

**Michael Baker International**

3900 C Street, Suite 900  
Anchorage, AK 99503  
907.273.1600

4/11/2018





## REVISION HISTORY

---

Revision	Date	Description
Draft	11/1/17	Issued for Review
A	01/8/18	Updated crash data
B	02/01/18	Update crash data to 2010-2014 data
C	02/16/18	Issued for Final Draft
D	04/11/18	Revised to adjust passing lane locations of P1 per public comment

## EXECUTIVE SUMMARY

---

The traffic and safety analyses outlined in this report are meant to provide insight into the performance of the alignment alternatives for the project. The Interactive Highway Safety Design Model (IHSDM) software was used to evaluate traffic, predict crash rates and determine design consistency. A summary of these analyses and general conclusions are provided below.

Traffic for all alignment alternatives, including the existing alignment, is expected to operate at an average Level of Service B. This level of service is indicative of the relatively high average travel speed (between 50 and 55 miles per hour [mph]) and low percent-time-spent-following (between 35-50%). The addition of southbound passing lane locations is expected to further improve traffic operations and reduce delays.

The overall crash rate for the corridor is expected to marginally decrease for the designed alignment alternatives. The overall crash rate for the existing corridor is approximately half of the Alaska statewide crash rate. The IHSDM Crash Prediction Module results were used to optimize predicted safety performance of specific segments. Correcting the substandard curves has the biggest impact on reducing crash rates.

All alignment alternatives show a high level of design consistency throughout the corridor. Only one segment of one alignment alternative showed a decrease in design consistency. This decrease can likely be eliminated by further refining the geometry.

# TABLE OF CONTENTS

Revision History .....	i
Executive Summary .....	ii
<b>1. Introduction .....</b>	<b>1</b>
<b>2. Alignment Alternatives .....</b>	<b>3</b>
<b>3. Traffic Analysis .....</b>	<b>4</b>
3.1 ATS .....	4
3.2 PTSF .....	7
3.3 LOS .....	10
3.4 Vehicle Delay .....	12
3.5 Conclusions .....	13
<b>4. Safety Analysis .....</b>	<b>14</b>
4.1 Crash History .....	14
4.2 Corridor Predicted Crash Rates .....	17
4.3 Site Specific Crash Rates .....	17
4.4 Conclusions .....	18
<b>5. Design Consistency .....</b>	<b>19</b>
5.1 DCM Results .....	19
5.2 Conclusions .....	19
<b>Appendix A. IHSDM TAM Reports .....</b>	<b>A-1</b>
<b>Appendix B. DOT&amp;PF Crash Data .....</b>	<b>B-2</b>
<b>Appendix C. IHSDM CPM Reports .....</b>	<b>C-3</b>
<b>Appendix D. IHSDM DCM Reports .....</b>	<b>D-1</b>

# TABLES

Table 2.1: Alignment Alternatives .....	3
Table 3.1: Summary of Data Used to Evaluate Traffic Performance .....	4
Table 3.2: LOS Criteria for Class I Two-Lane Roads .....	10
Table 4.1: Crash Types (2010-2014) .....	14
Table 4.2: Type of Crash by Severity (2010-2014) .....	14

# FIGURES

Figure 1.1: Project Corridor Overview Map .....	2
Figure 3.1: ATS for Alignment Alternatives .....	5
Figure 3.2: Southbound ATS MP 325-315 .....	6
Figure 3.3: Southbound ATS MP 315-305 .....	6
Figure 3.4: Northbound ATS MP 305-315 .....	7
Figure 3.5: Northbound ATS MP 315-325 .....	7
Figure 3.6: PTSF for Alignment Alternatives .....	8
Figure 3.7: Southbound PTSF MP 325-315 .....	8
Figure 3.8: Southbound PTSF MP 315-305 .....	9
Figure 3.9: Northbound PTSF MP 305-315 .....	9
Figure 3.10: Northbound PTSF MP 315-325 .....	10
Figure 3.11: Southbound LOS MP 325-315 .....	11
Figure 3.12: Southbound LOS MP 315-305 .....	11
Figure 3.13: Northbound LOS MP 305-315 .....	12

Figure 3.14: Northbound LOS MP 315-325.....	12
Figure 3.15: Total Delay for Alignment Alternatives .....	13
Figure 4.1: Crash Severity MP 305-315.....	15
Figure 4.2: Crash Severity MP 315-325.....	16
Figure 4.3: Predicted Corridor Crash Rates .....	17
Figure 4.4: Predicted Crash Rate MP 325-315.....	18
Figure 4.5: Predicted Crash Rate MP 315-305.....	18

## ACRONYMS AND ABBREVIATIONS

---

AADT	Average Annual Daily Traffic
ATS	Average Travel Speed
CPM	Crash Prediction Module
DCM	Design Consistency Module
DHV	Design Hourly Volume
DOT&PF	Department of Transportation and Public Facilities
IHSMDM	Interactive Highway Safety Design Model
LOS	Level of Service
Michael Baker	Michael Baker International
mi	mile
min/veh	minutes per vehicle
MVM	million vehicle mile
MP	Milepost
mph	Mile per hour
NB	Northbound
PFFS	Percent of free-flow speed
PTSF	Percent-time-spent-following
SB	Southbound
TAM	Traffic Analysis Module
V85	85 <sup>th</sup> percentile speed

# 1. INTRODUCTION

---

The Northern Region State of Alaska Department of Transportation and Public Facilities (DOT&PF) is reconstructing the Parks Highway from milepost (MP) 305 to 325. The purpose of the project is to provide a transportation facility with improved operational efficiency and safety that maintains or improves mobility and accessibility for people and goods along this Interstate route. The project begins at MP 325 at the Fairbanks North Star Borough boundary and ends at MP 305 at the Tanana River Bridge at Nenana. An overview map of the project corridor is shown in Figure 1.1.

As part of the project, Michael Baker International (Michael Baker) is providing preliminary engineering services, including this Traffic and Safety Report. The purpose of the Traffic and Safety Report is to compare the predicted traffic and safety performance of the alignment alternatives over the length of the corridor as well as at site specific locations.

The Federal Highway Administration's Interactive Highway Safety Design Model (IHSDM) software was used to evaluate the traffic and safety performance of each alignment. The IHSDM software includes a suite of modules for evaluating a roadway's performance. For this report, Michael Baker used the following modules:

- Traffic Analysis Module (TAM): Provides measures of traffic operations used in highway capacity and quality of service evaluations
- Crash Prediction Module (CPM): Estimates expected crash rates
- Design Consistency Module (DCM): Estimates expected operating speeds and their consistency over the length of a roadway



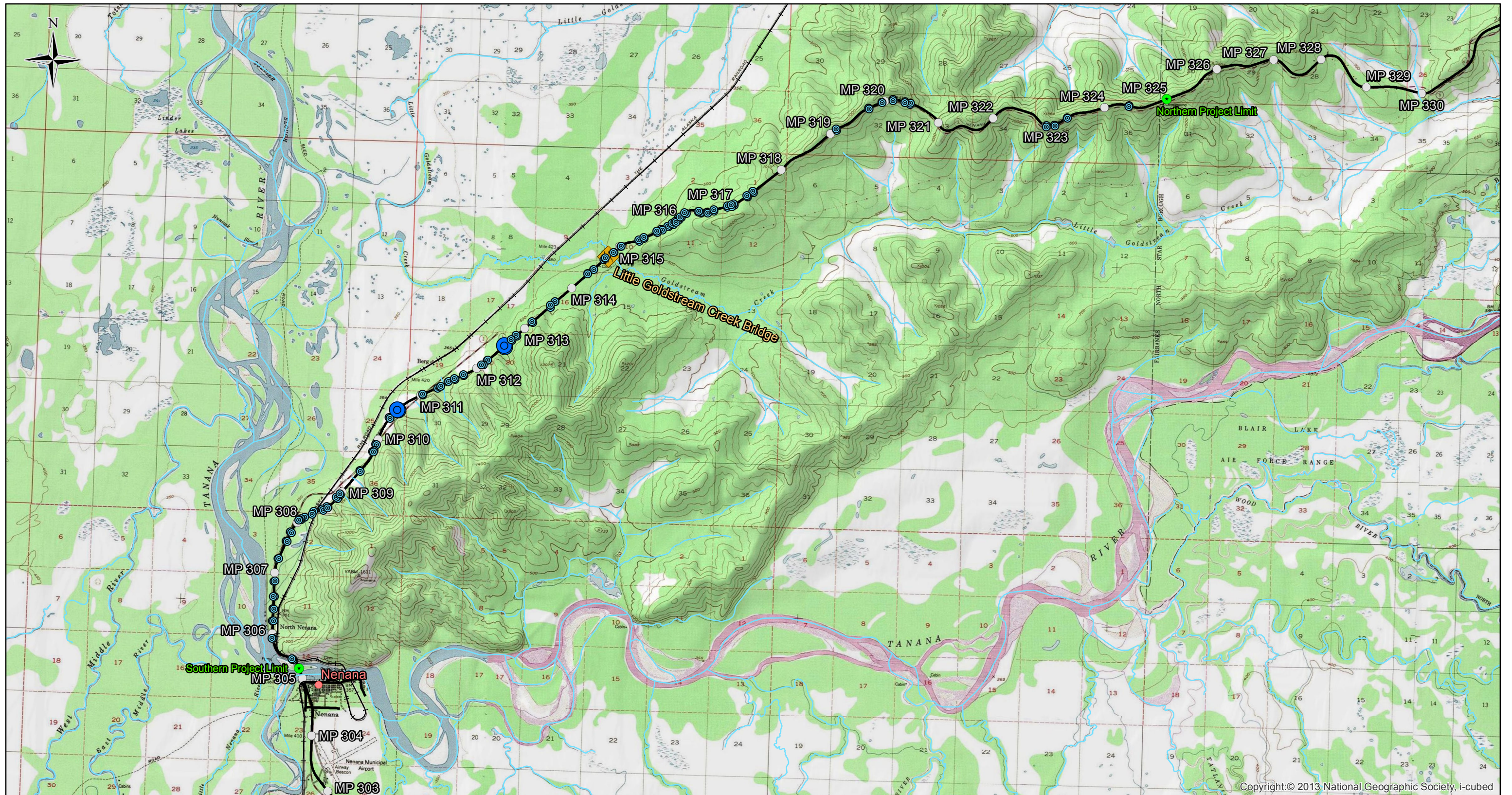

Copyright © 2013 National Geographic Society, i-cubed



**Alaska Department of  
Transportation & Public Facilities**  
**Parks Highway MP 305 to 325 Reconstruction**  
Project No. 0A45028/Z606570000

Existing Culverts		Legend	
● (Large Blue)	Major Culvert	○ (Small Blue)	AK DOT Milepost
● (Small Blue)	Minor Culvert	● (Red)	Place Name
◆ (Yellow)	AK DOT Bridge	● (Green)	Project Boundary
— (Black)	AK DOT Road	—+— (Black)	Railroad

**Figure 1.1 Project Overview Map**  
Scale: 1:95,040    1 inch = 1.5 miles  
0    0.75    1.5    3 Miles  
Fairbanks Custom Projection  
1983 (2011) North American Datum



3/17/2016



## 2. ALIGNMENT ALTERNATIVES

---

Five alignment alternatives were analyzed using FHWA's IHSDM software. The alignment alternatives are listed in Table 2.1:

**Table 2.1: Alignment Alternatives**

Alignment Alternative	Description
<b>Existing</b>	Existing alignment with a design speed of 60 miles per hour (mph).
<b>P1</b>	Alignment Alternative 1 using a design speed of 70 mph. This alternative focuses on minimizing traffic impacts during construction.
<b>P1_6</b>	Alignment Alternative 1 with a design exception allowing for a 6% maximum grade
<b>P2</b>	Alignment Alternative 2 with a design speed of 70 mph. This alternative focuses on balancing and minimizing earthwork volumes.
<b>P2_6</b>	Alignment Alternative 2 with a design exception allowing for a 6% maximum grade

### 3. TRAFFIC ANALYSIS

The 2016 Average Annual Daily Traffic (AADT) for the existing Parks Highway is 1,800 vehicles per day between MP 305 and MP 325. The annual growth rate of traffic is estimated to be approximately 1.25% per year and the 2040 design year AADT is projected to be 2,430 vehicles per day. The Design Hourly Volume (DHV) was estimated to be 14.5% of the design year AADT. The directional split for northbound (NB) versus southbound (SB) traffic is 35%/65%. This information as well as the number of passing and climbing lanes for each alternative is summarized in Table 3.1.

**Table 3.1: Summary of Data Used to Evaluate Traffic Performance**

Element	Existing	P1	P1_6	P2	P2_6
<b>Design Speed (mph)</b>	60	70	70	70	70
<b>Length (mi)</b>	22.0	21.6	21.6	20.8	20.8
<b>AADT (2016)</b>	1,800				
<b>Mid Design AADT (2030)</b>	2,140				
<b>Design AADT (2040)</b>	2,430				
<b>Directional Split (NB/SB)</b>	35/65				
<b>Percent Trucks</b>	17%				
<b>DHV</b>	14.5%				
<b>2016 NB DHV</b>	91				
<b>2016 SB DHV</b>	170				
<b>NB Passing Lane Locations</b>	4	2	3	3	3
<b>NB Climbing Lane Locations</b>	0	2	1	1	1
<b>SB Passing Lane Locations</b>	0	3	3	3	3
<b>SB Climbing Lane Locations</b>	0	0	0	0	0

The IHSDM TAM requires roadway geometry, design speed, percent trucks, passing lane locations, and traffic volumes for input to determine travel speed, time spent following, and free-flow speed. The results were analyzed to determine the Level of Service (LOS). At least one or more of the following three measures are typically used to measure the LOS of a two-lane highway. A discussion and evaluation of the measures used is provided in Section 3.1 and Section 3.2

- Average travel speed (ATS)
- Percent-time-spent-following (PTSF)
- Percent of free-flow speed (PFFS)<sup>1</sup>

#### 3.1 ATS

Average travel speed (ATS) reflects mobility along the corridor and is determined by dividing the highway segment length by the average travel time vehicles require to traverse that segment. Results of the ATS analysis for the alignment alternatives are summarized in Figure 3.1.

<sup>1</sup> **PFFS:** Represents the ability of vehicles to travel at or near the posted speed limit. It is used on two-lane highway segments in which local traffic often mixes with through traffic, and the density of unsignalized roadside access points is noticeably higher than in a purely rural area. Such conditions do not exist along the project corridor and thus PFFS was not calculated.

The engineered alignment alternatives vary by a maximum of 0.6 mph. The combined ATS increases by an average of 2.5 mph or 4.6% for the engineered alignment alternatives compared to the existing alignment. The reason for only a slight increase in ATS is that the low traffic volumes and rural nature of the existing roadway allow it to have a high ATS to begin with.

Figure 3.1: ATS for Alignment Alternatives

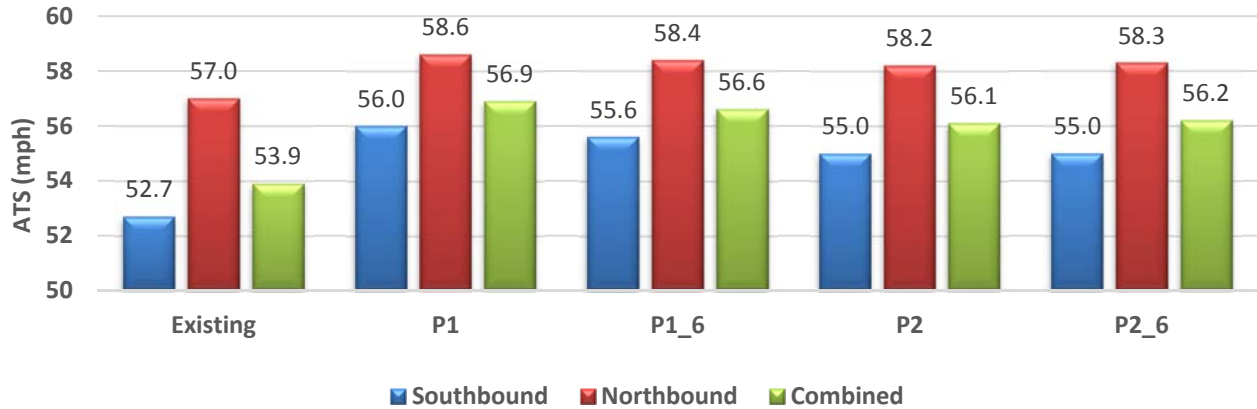

Figure 3.2 and Figure 3.3 shows the ATS along the corridor in the southbound direction. The improvements to the geometry and added passing lanes contribute to an increase in ATS. For example, flattening the horizontal curves near MP 321 increase the ATS from 47 mph for the existing alignment to 56 mph for the P1 alignment alternative. The addition of a passing lane near MP 319 increases the ATS from 47 mph to 61 mph for the P1 alignment alternative. While the improvements vary among the engineered alignments, the engineered alignments do show a consistent overall increase in ATS over the existing alignment.

Figure 3.2: Southbound ATS MP 325-315

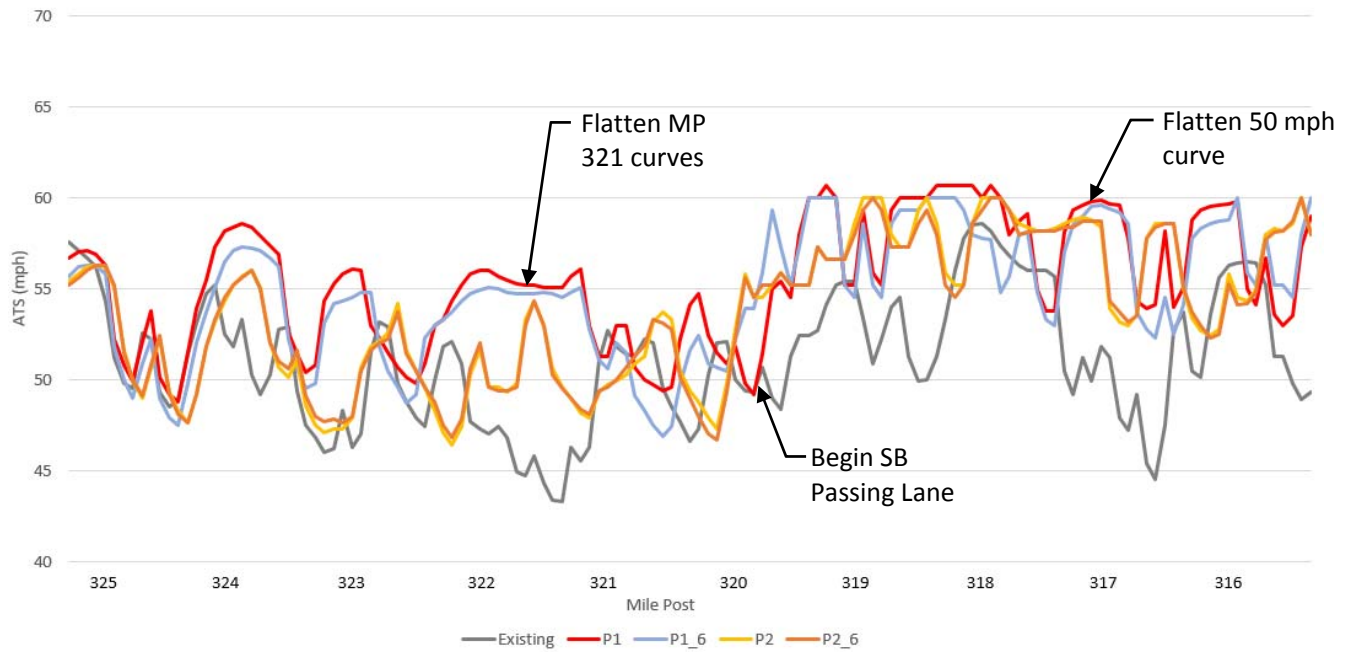

Figure 3.3: Southbound ATS MP 315-305

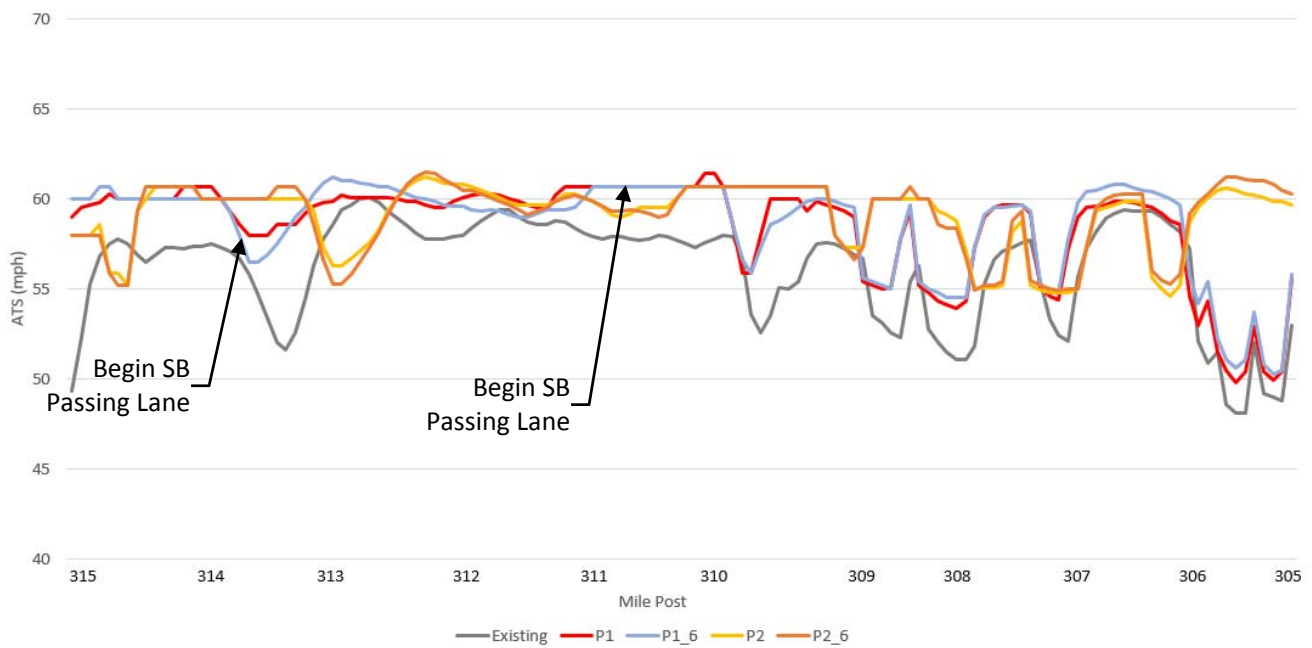

Figure 3.4 and Figure 3.5 shows the ATS along the corridor in the northbound direction. The improvements to the geometry and added passing lanes contribute to an increase in ATS. For example, flattening the 50-mph horizontal curve and adding a passing lane at MP 317 increase the ATS from 50 mph to 60 mph for the P1 alignment alternative. Similarly, flattening horizontal curves and improving the climbing lane near MP 321 increase the ATS from 49mph to 62 mph for the P1 alignment alternative.

Figure 3.4: Northbound ATS MP 305-315

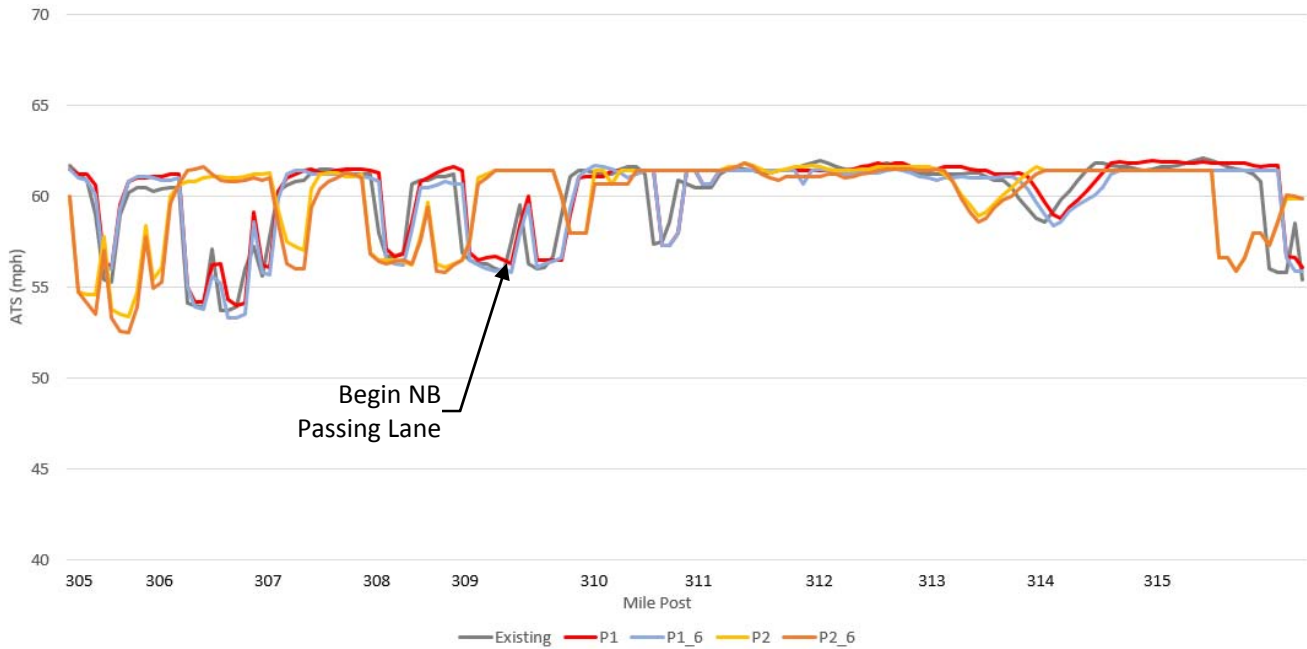
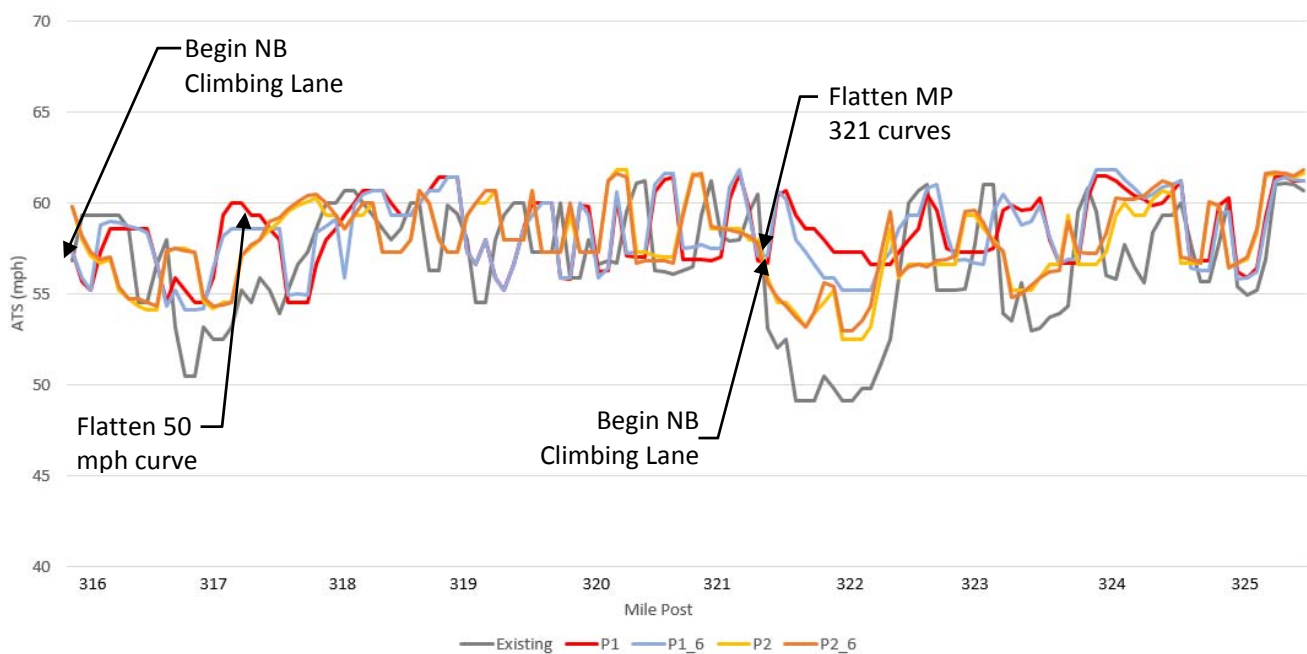

Figure 3.5: Northbound ATS MP 315-325



### 3.2 PTSF

Percent time spent following (PTSF) represents the freedom to maneuver and convenience of travel. It is determined by the average percent of total travel time that vehicles must travel in platoons behind slower vehicles due to the inability to pass on a two-lane highway. Results of the PTSF analysis for the alignment alternatives are summarized in Figure 3.6.

Figure 3.6: PTSF for Alignment Alternatives

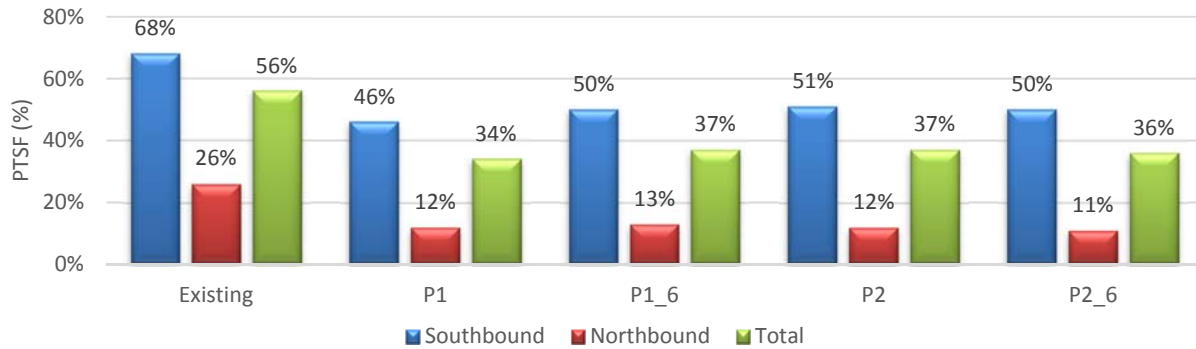

As noted in Table 3.1, the engineered alignments each have three SB and four NB passing lane locations, and the existing alignment has zero SB and four NB passing lane locations. The effect of the proposed passing lane improvements is to break up platoons of vehicles, primarily in the SB direction, thus improving traffic operations on the entire highway.

Figure 3.7 and Figure 3.8 show the PTSF in the southbound direction for the alignment alternatives. PTSF decreases with the engineered alignments where the passing lanes are introduced near MP 320, 316, and 311. At MP 320 the PTSF drops from 70% to 40%; at MP 316 the PTSF drops from 50% to 25%; at MP 311 the PTSF drops from 40% to 15%.

Figure 3.7: Southbound PTSF MP 325-315

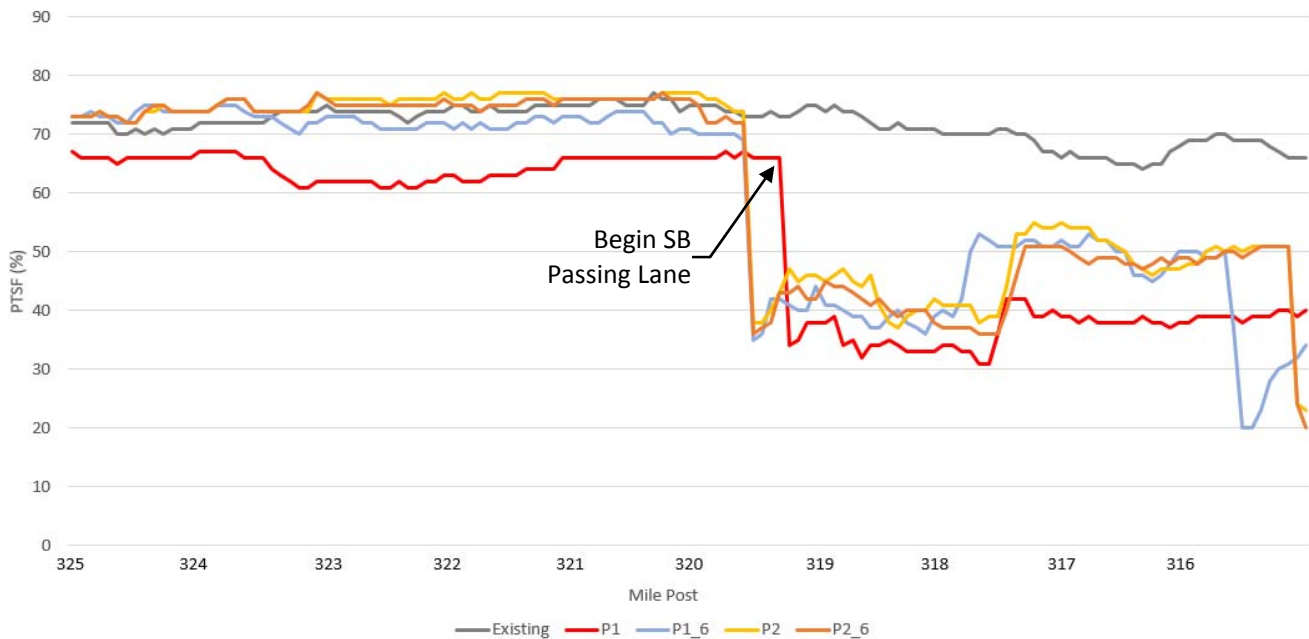



Figure 3.8: Southbound PTSF MP 315-305

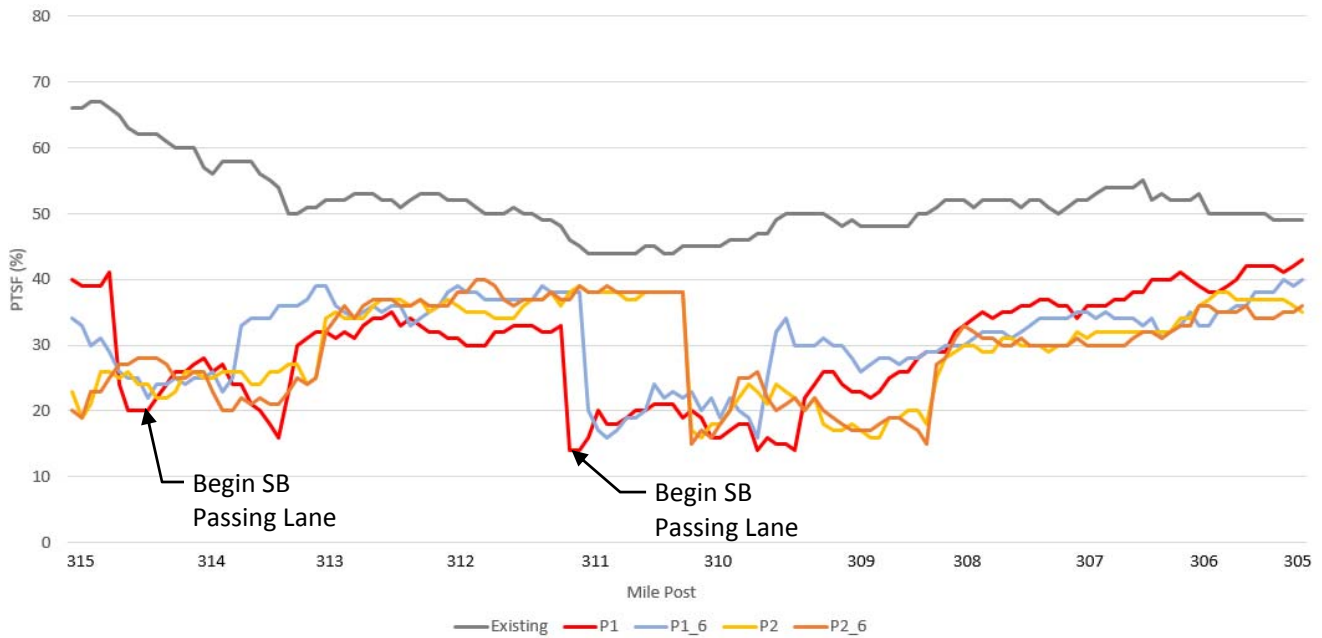

Figure 3.9 and Figure 3.10 show the PTSF in the northbound direction for the alignment alternatives. PTSF minimally changes from existing considering that passing lanes are existing. Extending the southernmost passing lane contributes to decreased PTSF between MP 308 and 312, dropping the PTSF from 15% to 4%.

Figure 3.9: Northbound PTSF MP 305-315

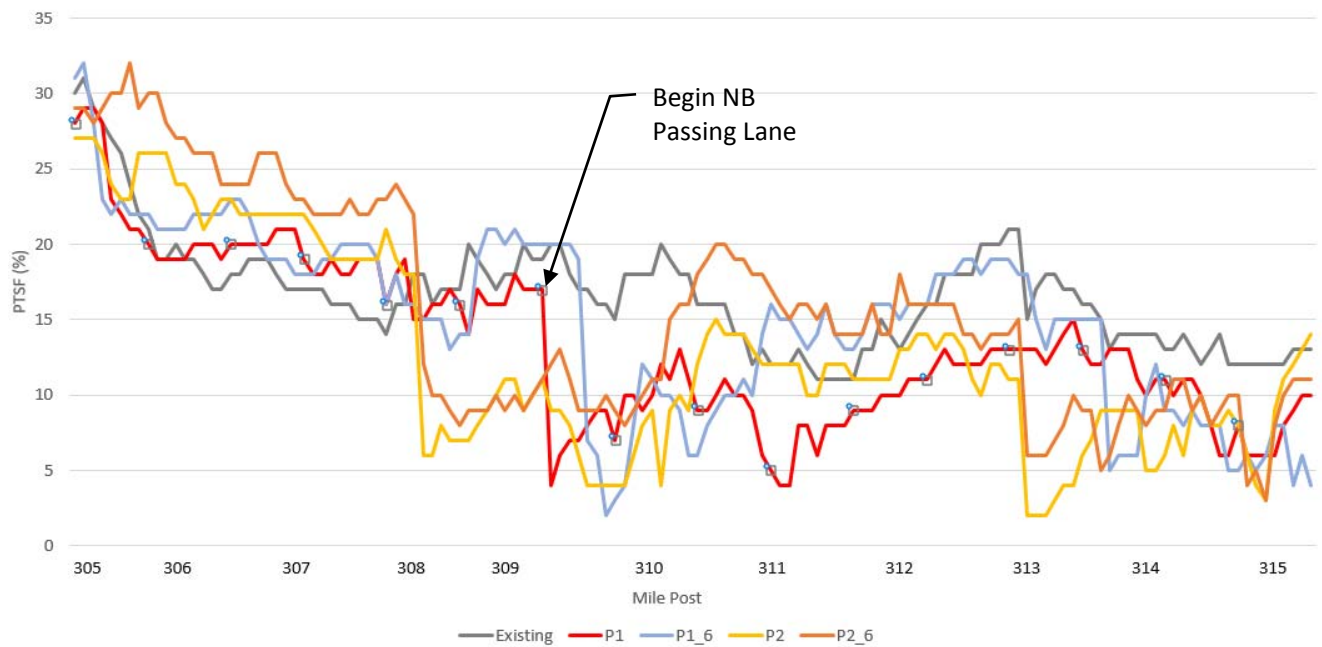
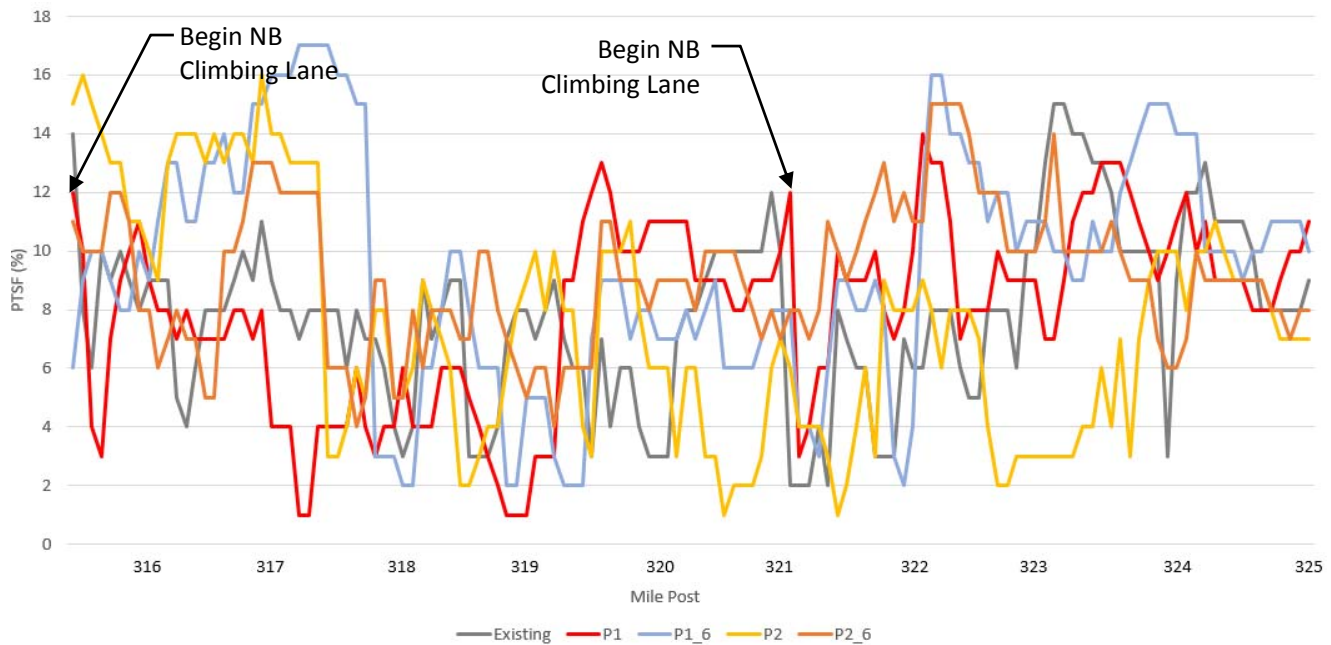

Figure 3.10: Northbound PTSF MP 315-325



The engineered alignments have an average of 18% less PTSF over the existing alignment in the SB direction and an average of 13% less PTSF in the NB direction. The average change in PTSF is 20% less in the combined directions. The decrease in the SB direction can be attributed to adding the three passing lanes in that direction. The smaller change in the NB direction can be attributed to maintaining the passing lanes and geometric improvements which will slightly decrease platooning.

### 3.3 LOS

Level of Service (LOS) can be calculated for a Class I Two-Lane Road<sup>2</sup> based on ATS and PTSF as shown in Table 3.2.

Table 3.2: LOS Criteria for Class I Two-Lane Roads

LOS	ATS (mph)	PTSF (%)
A	>55	≤35
B	>50–55	>35–50
C	>45–50	>50–65
D	>40–45	>65–80
E	≤40	>80

The southbound LOS ranges from LOS D to LOS A as shown in Figure 3.11 and Figure 3.12. LOS is generally greater for the engineered alignment alternatives. The low LOS from MP 325 to 319 is attributed to a high AADT entering the corridor from the north with limited passing opportunities until MP 319. It is cost prohibitive to provide passing lanes or passing sight distance from MP 325 to MP 319. From MP 319 to 315 the LOS increases to LOS B for P1 alignment alternative and is LOS B or C for the remaining engineered alignment alternatives. From MP 315 to 305, as the alignment becomes less curvilinear and has increased passing opportunities, the LOS increases to LOS A or B for the engineered alignment alternatives. The increase in LOS can be attributed to geometric improvements and addition of passing lanes.

<sup>2</sup> Class I Two-Lane Roads: Relatively high-speed roads, arterials, primary highways. LOS is based on both PTSF and ATS.

Figure 3.11: Southbound LOS MP 325-315

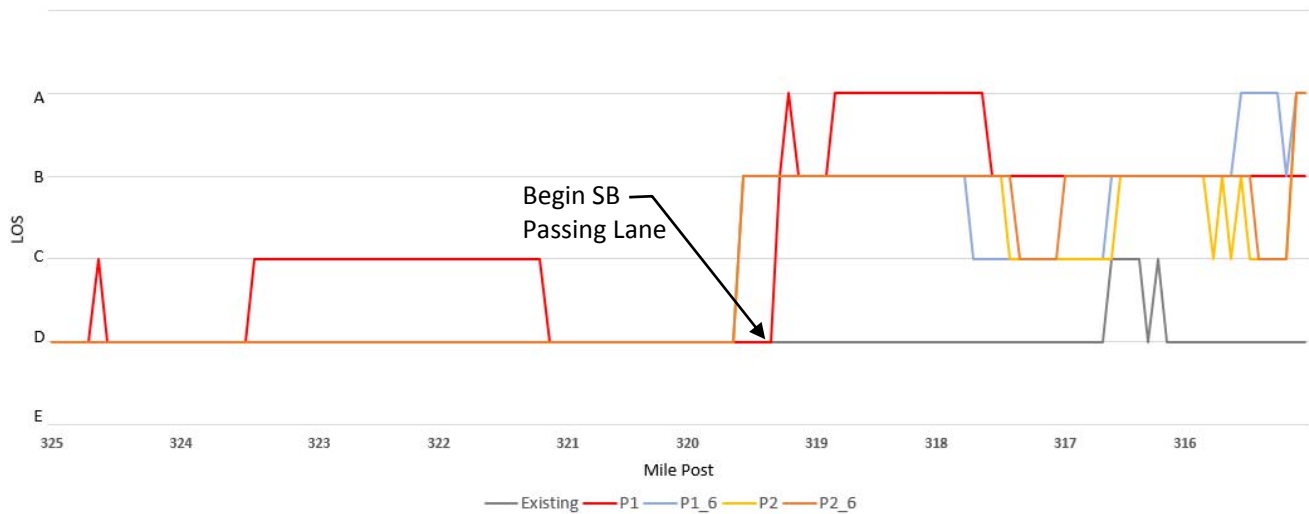
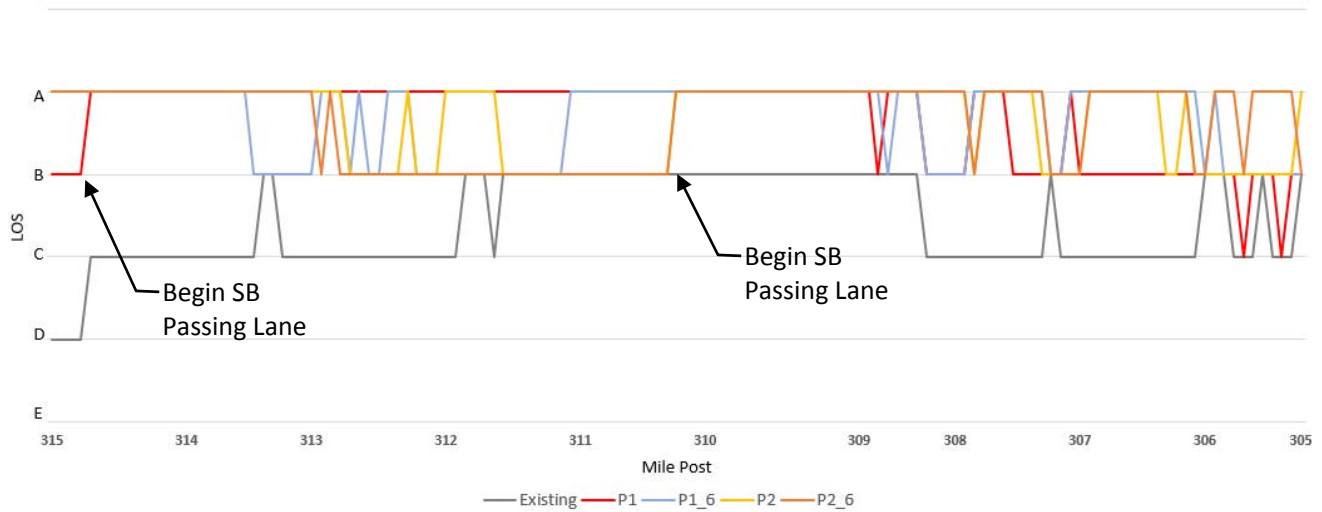

Figure 3.12: Southbound LOS MP 315-305



The northbound LOS ranges from LOS B to A for most of the corridor. Near MP 320 the LOS drops to LOS C as the ATS decreases up a long steep grade. The addition of the climbing lane, at this location, increases the LOS to a LOS A, as seen in Figure 3.14. The LOS is high due to the lower AADT northbound.

Figure 3.13: Northbound LOS MP 305-315

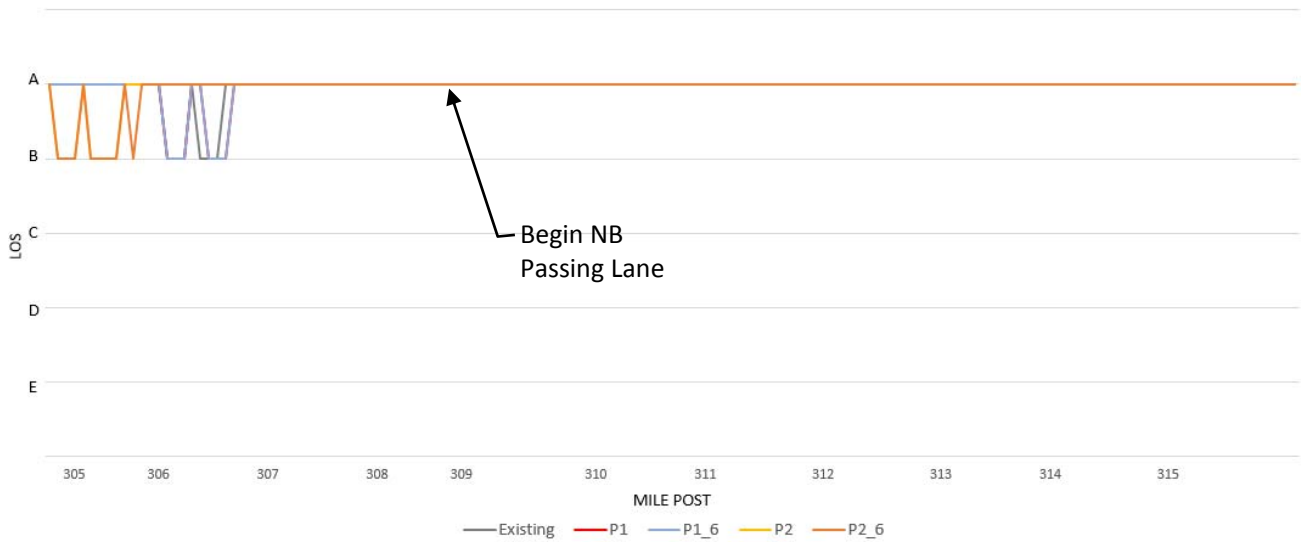
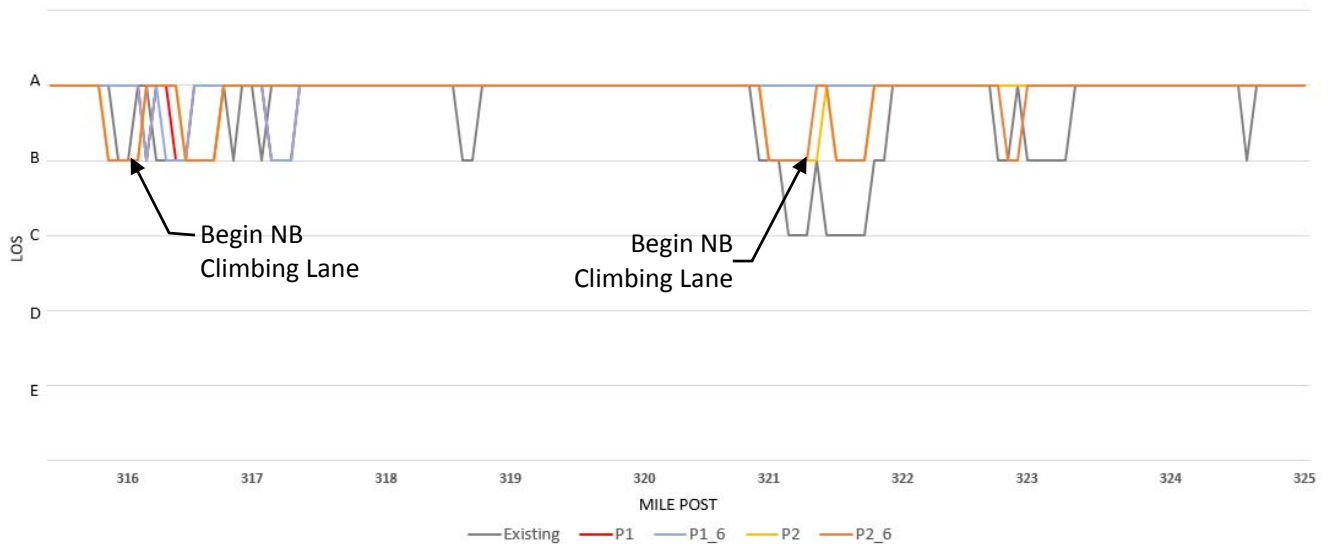

Figure 3.14: Northbound LOS MP 315-325



### 3.4 VEHICLE DELAY

An additional approach to evaluate traffic performance is to estimate the delay. The TAM uses the roadway geometry and simulated traffic interactions to estimate delay along the alignment. Results of the total delay for the alignment alternatives are summarized in Figure 3.15.

Figure 3.15: Total Delay for Alignment Alternatives

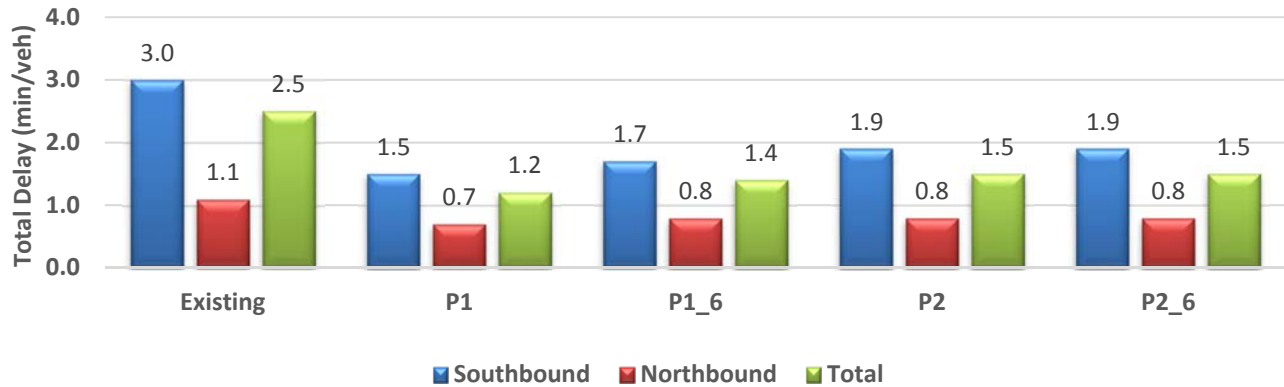

The TAM shows total delay for the existing alignment exceeding 2.5 minutes per vehicle (min/veh) for the combined NB and SB traffic. The proposed alternatives have total delays of 1.5 min/veh or less. The decrease in total delay for the engineered alignments can be attributed to the addition of the SB passing lanes and geometric improvements.

### 3.5 CONCLUSIONS

The engineered alignments and additional passing lanes improve traffic operations over the existing alignment. The overall ATS increases by 2.5 mph, the PTSF decreases by 20%, and the total delay decreases by 1.0 min/veh. All alignment alternatives will provide an improved LOS. The traffic operation improvements are not substantial and the TAM analysis suggests that the overall existing alignment traffic operations are acceptable. However, the TAM analysis also shows site specific locations, such as MP 320 and MP 316, where the engineered alignments provide a substantial improvement in traffic operations. The IHSDM TAM output reports are included in Appendix A.

## 4. SAFETY ANALYSIS

The 2011 Alaska Traffic Crashes, Alaska Department of Transportation and Public Facilities, July 2015 report is referenced throughout this section as a basis of comparison for project crash history and analysis. It is the most recent available information regarding statewide crash rates and distributions, however it may not constitute an “apples to apples” comparison as the data used was 2009-2011 and the crash data utilized for this analysis is 2010-2014.

### 4.1 CRASH HISTORY

DOT&PF provided available crash data for the period from 2010 to 2014. The data is included in Appendix B. During that time, a total of 49 non-fatal crashes were reported between MP 305 and MP 325. Of those crashes, 80% were single vehicle crashes and 18% were multi-vehicle crashes. One vehicle-bicycle crash and no vehicle-pedestrian crashes were reported during that period. The reported roadway crash types are summarized in Table 4.1.

**Table 4.1: Crash Types (2010-2014)**

	2010	2011	2012	2013	2014	Total	Percent
<b>Single Vehicle</b>	5	6	6	5	17	39	80%
<b>Multi-vehicle</b>	3	0	1	1	4	9	18%
<b>Vehicle-Bicycle</b>	1	0	0	0	0	1	2%
<b>Vehicle-Pedestrian</b>	0	0	0	0	0	0	0%
<b>Total Crashes</b>	9	6	7	6	21	49	100%

A summary of the reported severity for each crash and the 2011 statewide distribution is provided in Table 4.2. The crash distribution by severity for this section of the Parks Highway is comparable to the 2011 statewide average distribution. The major/minor injury only crashes were 8.5% higher than the statewide percentage.

**Table 4.2: Type of Crash by Severity (2010-2014)**

	2010	2011	2012	2013	2014	Total	Percent	2011 Statewide Percent
<b>Property Damage Only</b>	6	4	5	3	14	32	65%	73%
<b>Major/Minor Injury Only</b>	3	2	2	3	7	17	35%	26.5%
<b>Fatal</b>	0	0	0	0	0	0	0%	1.44%
<b>Total</b>	9	6	7	6	21	49	100%	100%

### FATAL CRASHES

From 2010 and 2014 no fatal crashes were reported. However, two fatal crashes were reported in 2016<sup>3</sup> and 2017<sup>4</sup>. Figure 4.1 and Figure 4.2 show the crashes by severity along the project corridor.

<sup>3</sup> January 12, 2016 Fairbanks Daily News Miner

<sup>4</sup> August 23, 2017 Fairbanks Daily News Miner



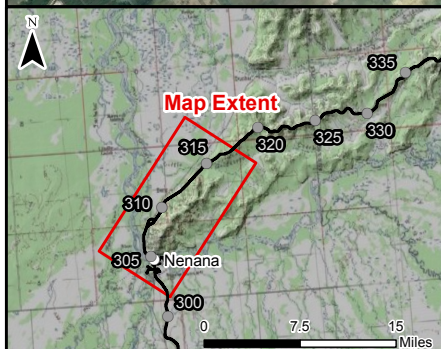

- Bridge
- Proposed Alignment
- Parks Highway
- Alaska Railroad
- Parks Highway Milepost
- Place Name
- Bicycle / Motor Vehicle Collision

**Accident Severity (Number of Individual Accidents)**

Fatal	Injury	Property Damage Only					
1	1	2	3	1	2	3	4

Crash Data from 2010 to 2014 and Fatal Crash Data from 2010 to 2017 were obtained from the State-wide database of motor vehicle traffic crashes maintained by Alaska DOT & PF.

**Parks Highway MP 305 to 325 Reconstruction**  
**Figure 4.1 Crash Severity**

Scale: 1:47,520      1 inch = 0.75 miles

Fairbanks Custom Projection  
 1983 (2011) North American Datum

**Alaska Department of Transportation & Public Facilities**

Prepared by:  
 Michael Baker International, Inc.      2/1/2018



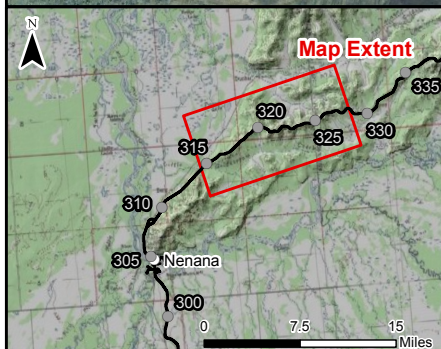

Bridge  
 Proposed Alignment  
 Parks Highway Milepost  
 Parks Highway  
 Alaska Railroad

**Accident Severity (Number of Individual Accidents)**

Fatal	Injury	Property Damage Only						
1	1	3	5	1	2	3	4	6

Crash Data from 2010 to 2014 and Fatal Crash Data from 2010 to 2017 were obtained from the State-wide database of motor vehicle traffic crashes maintained by Alaska DOT & PF.

**Parks Highway MP 305 to 325 Reconstruction**  
**Figure 4.2 Crash Severity**

Scale: 1:47,520      1 inch = 0.75 miles

Fairbanks Custom Projection  
 1983 (2011) North American Datum

**Alaska Department of Transportation & Public Facilities**

Prepared by:  
 Michael Baker International, Inc.      2/1/2018



## 4.2 CORRIDOR PREDICTED CRASH RATES

Predicted crash rates for the existing alignment and proposed alternatives were developed using the IHSDM CPM. The CPM requires roadway geometry, design speed, and traffic volumes for input. The CPM was calibrated using the existing crash history data. The results are summarized in with Figure 4.3 comparison to the historical crash rate for the corridor.

Figure 4.3: Predicted Corridor Crash Rates

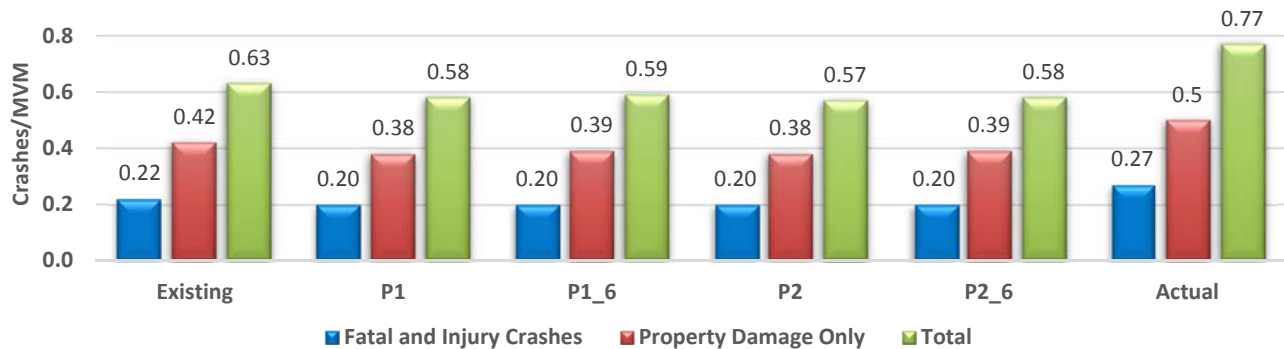

The predicted total crash rates for all alignment alternatives range between 0.57 and 0.63 crashes per MVM. This is below the historical crash rate for the corridor of 0.77 crashes per MVM and below the 2011 statewide average of 1.04 crashes per MVM for undivided urban and rural interstate highways. Fatal and injury crash rates varied from 0.20 to 0.22 crashes per MVM<sup>5</sup> and property damage only crash rates varied from 0.38 to 0.42 crashes/MVM. The decrease in predicted crash rates for the engineered alignments can be attributed to geometric improvements.

## 4.3 SITE SPECIFIC CRASH RATES

Individual locations within each alignment alternative exhibit predicted crash rates substantially higher than the corridor average as shown in Figure 4.4 and Figure 4.5. Locations where the engineered alignments demonstrate high predicted crash rates include MPs 324-323, 321-319, and 308-306. Improving the horizontal geometry from 321 to 319 decreases the predicted crash rate, however due to this section having a long 5% grade and horizontal curve the predicted crash rates are still elevated. The higher crash rates from 324 to 323 and 308 to 306, can be attributed to the horizontal geometry. Additional geometric improvements may further reduce the predicted crash rates at these locations.

<sup>5</sup> The IHSDM software does not report separate fatal crash rates and injury crash rates.

Figure 4.4: Predicted Crash Rate MP 325-315

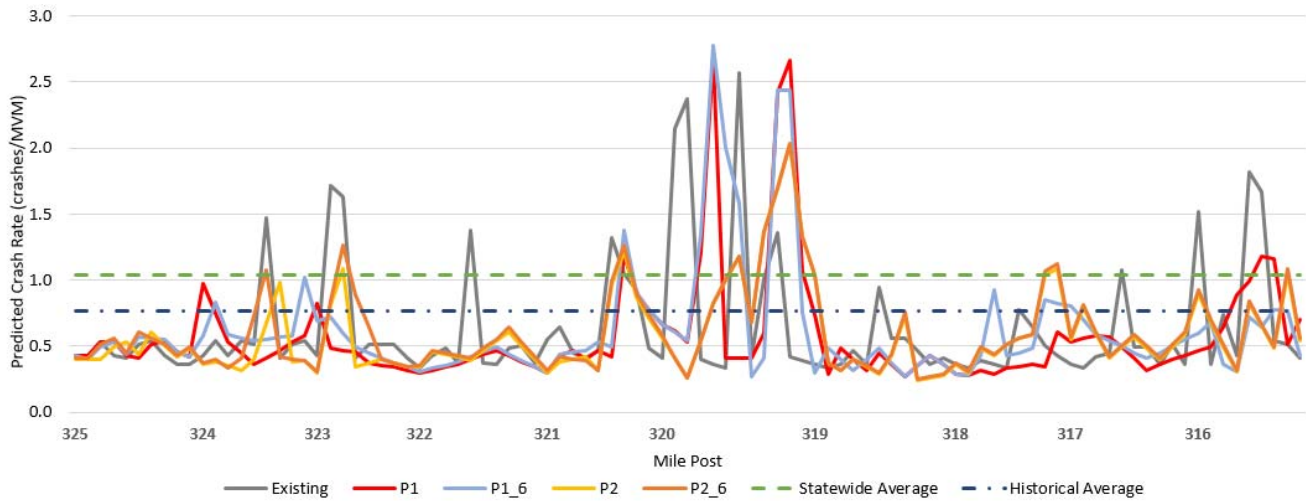
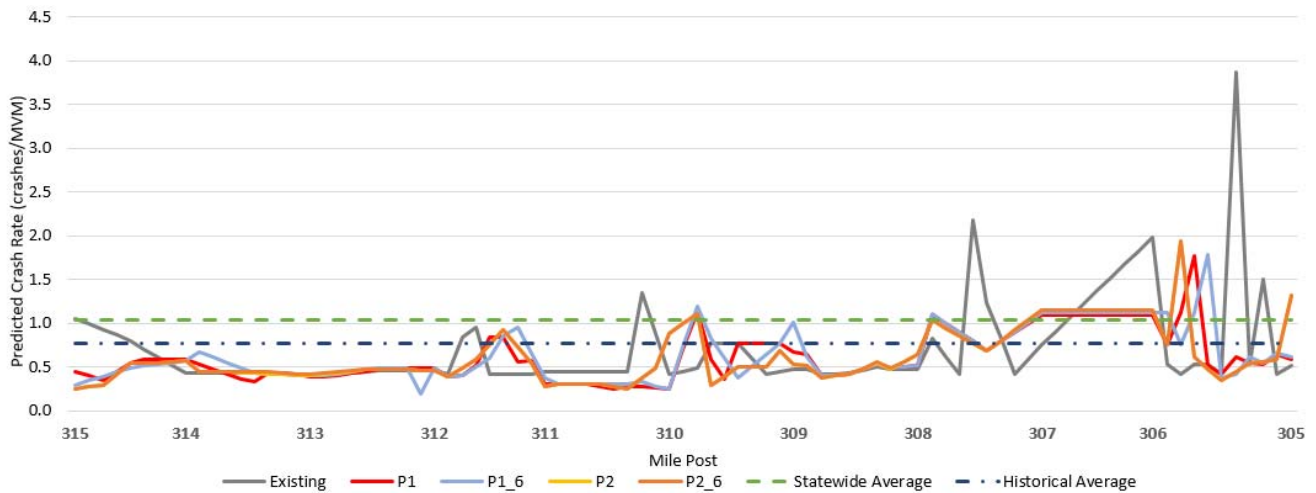

Figure 4.5: Predicted Crash Rate MP 315-305



#### 4.4 CONCLUSIONS

The overall predicted crash rate for the corridor as determined using the IHSDM CPM is very similar between the existing alignment and the engineered alignments. The crash rates for all alignments is approximately half the 2011 statewide average value for this type of roadway. The consistent crash rate can be attributed to the low traffic volumes, low number of historical crashes, and the limited geometric improvements from MP 315-305, i.e. if MP 305-315 had more substandard geometry, the existing alignment may have had a higher crash rate in this area. Improving the engineered alignment geometry to meet design standards improves the predicted crash rate at site specific locations. Additional site specific geometric improvements may further reduce the predicted crash rates at these locations. The IHSDM CPM output reports are included in Appendix C.

## 5. DESIGN CONSISTENCY

---

The DCM uses the geometric design to estimate operating speeds (85<sup>th</sup> percentile speed [V85]) and then measures the geometric design against driver expectations for a given speed. The analysis produces a speed profile identifying locations where the speed differential changes by one of the following conditions:

- Condition 1:  $(V85_{Tangent} - V85_{Curve}) \leq 6$  mph
- Condition 2:  $6 \text{ mph} < (V85_{Tangent} - V85_{Curve}) \leq 12$  mph
- Condition 3:  $12 \text{ mph} < (V85_{Tangent} - V85_{Curve})$

The three conditions represent an increasingly less geometrically consistent roadway. Crash rates correlate highly with design consistency. For example, average crash rates for curves requiring greater than 12 mph speed reductions were six times the average crash rates for curves requiring less than 6 mph. Estimated average crash rates for curves requiring 6-12 mph speed reductions were three times the average crash rates for curves requiring less than 6 mph.<sup>6</sup>

### 5.1 DCM RESULTS

The alignments were analyzed with a desired speed of 65 mph to match the posted speed of the corridor. The DCM results revealed that the corridor experiences Condition 1 for all engineered alignment alternatives with one exception. The P2 alignment alternative experiences a Condition 2 situation in the NB direction near MP 321. The tangent leading into the curve results in a 7 mph drop in the V85 speed from 64 mph to 57 mph. This can likely be eliminated by further refining the geometry. Compared to the existing alignment, which experiences three locations having the Condition 2 situation.

### 5.2 CONCLUSIONS

Overall the alignment alternatives show a high level of design consistency. The IHSDM DCM output reports are included in Appendix D.

---

<sup>6</sup> 2017 IHSDM Engineers Manual

## **Appendix A. IHSDM TAM Reports**



*Interactive Highway Safety Design Model*

**Traffic Analysis Evaluation Report**

**Existing Alignment**

January 4, 2018



## **Disclaimer**

The Interactive Highway Design Model (IHSDM) software is disseminated under the sponsorship of the Department of Transportation in the interest of information exchange. The United States Government assumes no liability for its content or use thereof. This document does not constitute a standard, specification, or regulation.

The United States Government does not endorse products or manufacturers. Trade and manufacturers' names may appear in this software and documentation only because they are considered essential to the objective of the software.

## **Limited Warranty and Limitations of Remedies**

This software product is provided "as-is," without warranty of any kind-either expressed or implied (but not limited to the implied warranties of merchantability and fitness for a particular purpose). The FHWA do not warrant that the functions contained in the software will meet the end-user's requirements or that the operation of the software will be uninterrupted and error-free.

Under no circumstances will the FHWA be liable to the end-user for any damages or claimed lost profits, lost savings, or other incidental or consequential damages rising out of the use or inability to use the software (even if these organizations have been advised of the possibility of such damages), or for any claim by any other party.

## **Notice**

The use of the IHSDM software is being done strictly on a voluntary basis. In exchange for provision of IHSDM, the user agrees that the Federal Highway Administration (FHWA), U.S. Department of Transportation and any other agency of the Federal Government shall not be responsible for any errors, damage or other liability that may result from any and all use of the software, including installation and testing of the software. The user further agrees to hold the FHWA and the Federal Government harmless from any resulting liability. The user agrees that this hold harmless provision shall flow to any person to whom or any entity to which the user provides the IHSDM software. It is the user's full responsibility to inform any person to whom or any entity to which it provides the IHSDM software of this hold harmless provision.

## Table of Contents

<b>Report Overview</b> .....	<b>1</b>
<b>Traffic Analysis Graphical Results</b> .....	<b>2</b>
<b>Simulation Input Data</b> .....	<b>7</b>
<b>Simulation Output Summary</b> .....	<b>9</b>
<b>Simulation Station Summaries</b> .....	<b>10</b>

## List of Tables

Table Simulation Parameters .....	7
Table Random Number Generator Seeds .....	7
Table Traffic Input Data .....	8
Table Section Summary .....	9
Table Station Summary (Increasing) .....	10
Table Station Summary (Decreasing) .....	16

## List of Figures

Figure Graphical Results (Increasing) .....	3
Figure Graphical Results (Decreasing) .....	5

## **Report Overview**

**Report Generated:** Jan 4, 2018 9:13 AM

**Report Template:** System: Multi-Page [System] (tam2, Oct 9, 2017 1:45 PM)

**Evaluation Date:** Wed Jan 03 13:15:46 AKST 2018

**IHSDM Version:** v13.0.0 (Sep 13, 2017)

**Traffic Analysis Module:** v1.6.0 (Mar 24, 2017)

**User Name:** RaeAnne Hebnes

**Organization Name:** Michael Baker International

**Phone:**

**E-Mail:**

**Project Title:** Parks 305 - 325 v2

**Project Comment:** Created using wizard

**Project Unit System:** U.S. Customary

**Highway Title:** Alignment ParksHwy304-326 Asbuilt - 60 mph

**Highway Comment:** Created By Civil Geometry

**Highway Version:** 1

**Evaluation Title:** Evaluation 16

**Evaluation Comment:** Created Wed Jan 03 13:13:45 AKST 2018

**Minimum Station:** 1327+09.000

**Maximum Station:** 2487+37.299

**Configuration Name:** Default

## **Traffic Analysis Graphical Results**

[[Graphical Results in the Engineer's Manual](#)]

Figure 1 below displays the graphical results of the Traffic Analysis Module evaluation for the increasing direction of travel.



Traffic Analysis Summary, Increasing Direction of Travel  
 Project: Parks 305 - 325 v2, Evaluation: Evaluation 16  
 Highway: Alignment ParksHwy304-326 Asbuilt - 60 mph

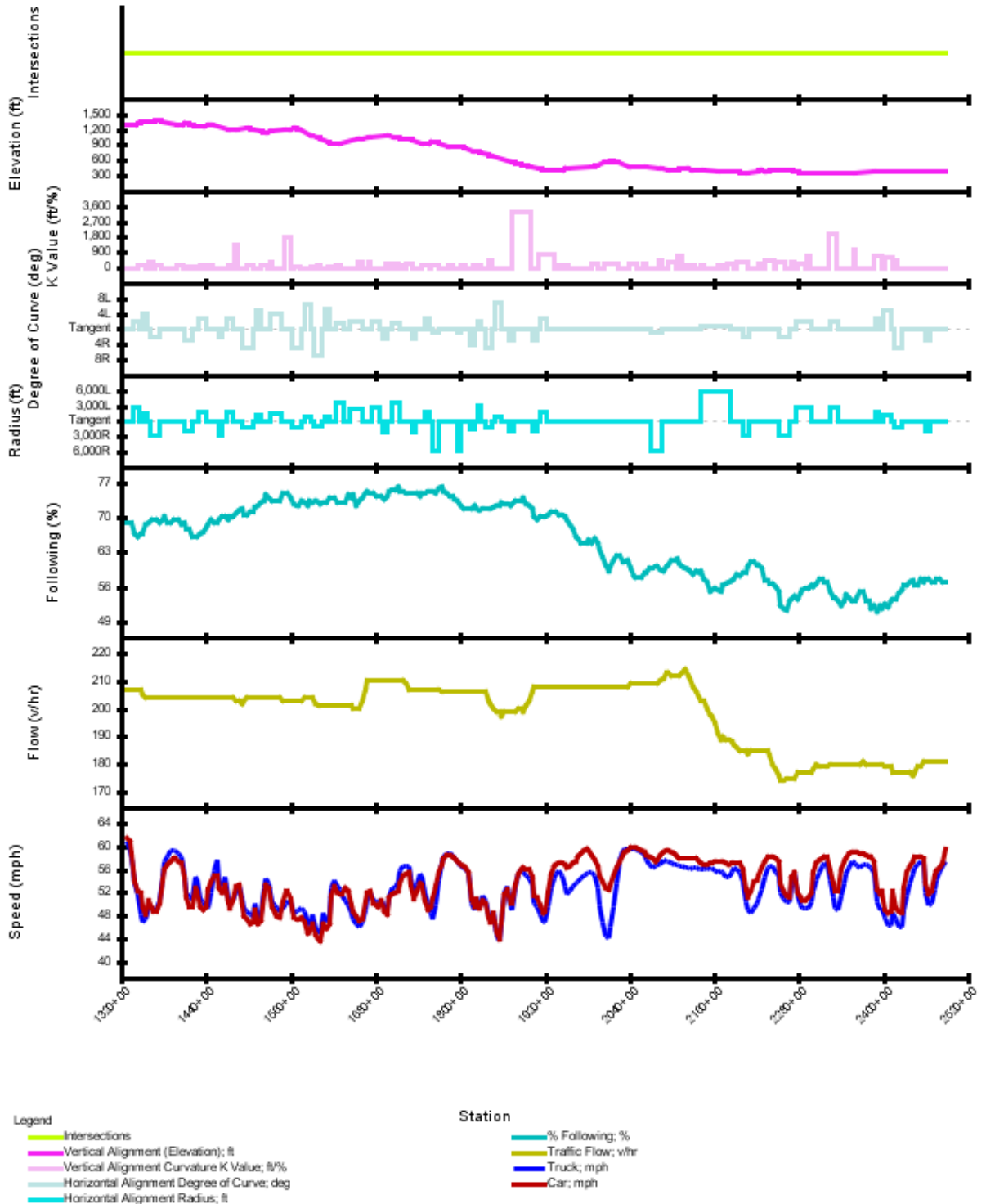

Figure 1. Graphical Results (Increasing)

Figure 2 below displays the graphical results of the Traffic Analysis Module evaluation for the decreasing direction of travel.

Traffic Analysis Summary, Decreasing Direction of Travel  
 Project: Parks 305 - 325 v2, Evaluation: Evaluation 16  
 Highway: Alignment ParksHwy304-326 Asbuilt - 60 mph

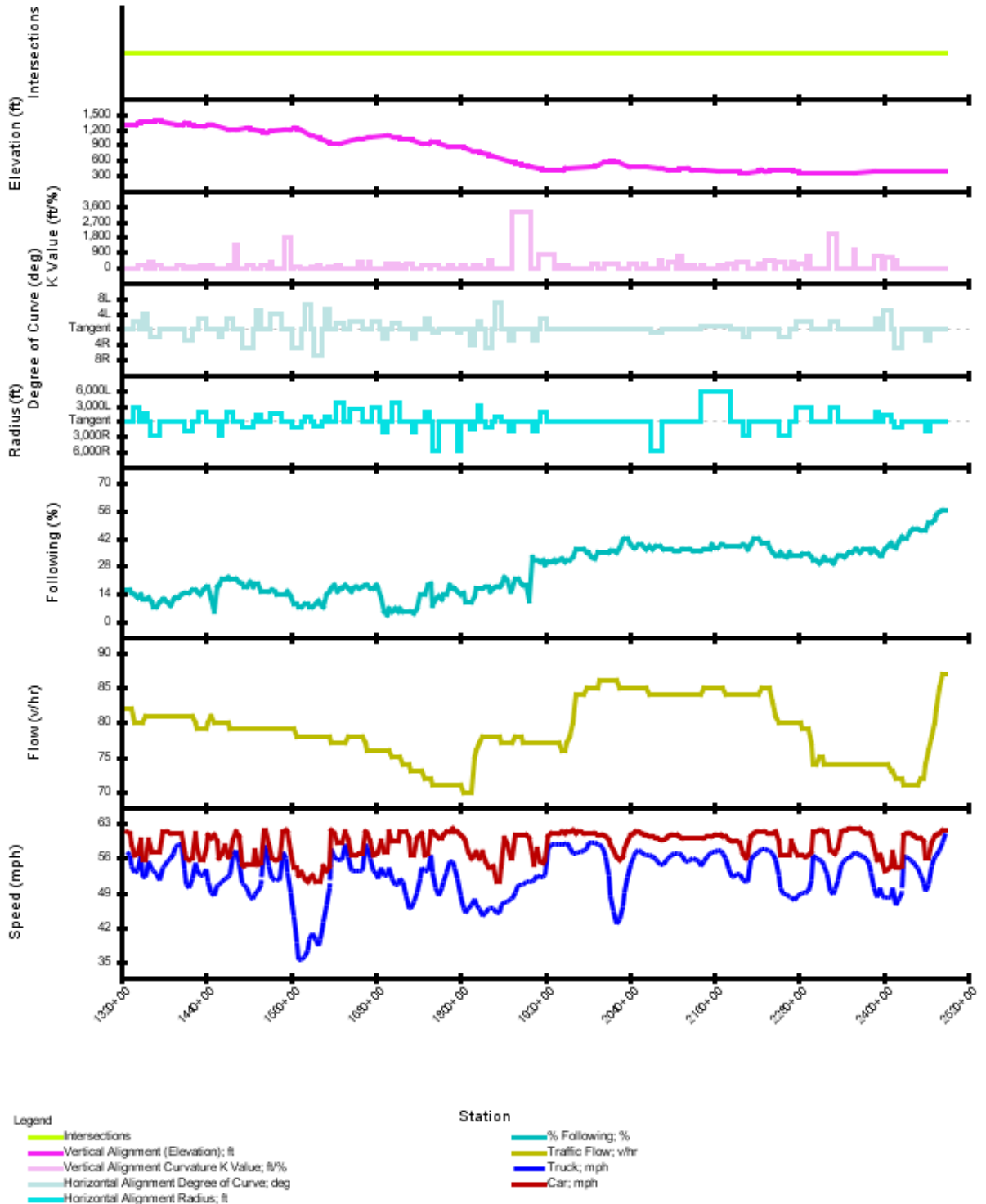

Figure 2. Graphical Results (Decreasing)



## Simulation Input Data

[Traffic Input Data in the Engineer's Manual]

**Table 1. Simulation Parameters**

Simulation Time (min)	60
Warm-up Time (min)	10
Total Time (min)	70
Computer Time (sec)	1
Test Road Length (mi)	21.9751

**Table 2. Random Number Generator Seeds**

Description	Value
Entering Traffic in Platoons / Direction of Increasing Stations	81250132
Desired Speed / Direction of Increasing Stations	70867724
Entering Traffic in Platoons / Direction of Decreasing Stations	33333334
Desired Speed / Direction of Decreasing Stations	16532240
Passing Decisions	52338126

**Table 3. Traffic Input Data**

Direction of Travel	Flow Rate (vph)	Distribution Cars (%)	Distribution Trucks (%)	Distribution RVs (%)	Mean Desired Speed Cars (mph)	Mean Desired Speed Trucks (mph)	Mean Desired Speed RVs (mph)	Desired Speed Standard Deviation Cars (mph)	Desired Speed Standard Deviation Trucks (mph)	Desired Speed Standard Deviation RVs (mph)	Entering Traffic in Platoons (%)	No Passing Zone (%)
Increasing	190	83	17	0	61.5	59.5	59.5	5.0	3.5	4.0	65	0
Decreasing	91	83	17	0	61.5	59.5	59.5	5.0	3.5	4.0	65	0



## Simulation Output Summary

[Section Summary in the Engineer's Manual]

Table 4 below includes the traffic output data table for the main road section. The table reports the actual simulated flow rate, percent time spent following, average speed, trip time, traffic delay, geometric delay, total delay, number of passes, vehicle-distance traveled, and vehicle-hours of travel. These simulation outputs are reported for each direction and both directions combined.

**Table 4. Section Summary**

Direction of Travel	Flow Rate from Simulation (vph)	Percent Time Spent Following (%)	Average Travel Speed (mph)	Trip Time (min/veh)	Traffic Delay (min/veh)	Geometric Delay (min/veh)	Total Delay (min/v eh)	Number of Passes	Distance Traveled (mi)	Total Travel Time (veh-hrs)
Increasing	200	68	52.7	24.8	1.9	1.1	3.0	212	4,361.4	82.7
Decreasing	80	26	57.0	22.8	-0.4	1.4	1.1	182	1,730.4	30.4
Combined	280	56	53.9	24.2	1.3	1.2	2.5	394	6,091.7	113.0

## Simulation Station Summaries

[Station Summary in the Engineer's Manual]

Table 5 below reports spot traffic operational data collected by the simulation at each data collection station for travel in direction of increasing stations. These data are analogous to data that would be collected by a traffic data recorder placed at the specified location on the highway during the simulation time. The data include hourly traffic volume; measured mean speed of cars, trucks, and recreational vehicles; mean and standard deviation speed for all vehicles combined; percent of vehicles following at a headway of less than 4 seconds; the average platoon size; and number of passes. A separate table is produced for each direction of travel. The data in this station summary data tables are used to create graphs.

**Table 5. Station Summary (Increasing)**

Station Number	Station	Number of Lanes	Traffic Volume (vpd)	Speed Mean Cars (mph)	Speed Mean Trucks (mph)	Speed Mean RVs (mph)	Speed Mean All (mph)	Percent Following (%)	Platoon Size	Number of Passes
1	1327+25.404	1	207	61.5	61.0	0.0	61.4	69	5.0	0.0
2	1331+13.349	1	207	60.8	59.3	0.0	60.5	69	5.0	0.0
3	1335+01.294	1	207	58.7	58.0	0.0	58.6	69	5.0	0.0
4	1338+89.238	1	207	53.9	53.5	0.0	53.8	67	4.4	0.0
5	1342+77.183	1	207	52.2	51.6	0.0	52.1	66	4.3	0.0
6	1346+65.128	1	207	51.9	48.1	0.0	51.4	67	4.5	0.0
7	1350+53.073	1	205	49.7	46.8	0.0	49.3	67	4.6	0.0
8	1354+41.017	1	204	48.2	47.5	0.0	48.1	69	5.1	0.0
9	1358+28.962	1	204	50.6	49.6	0.0	50.5	69	5.3	0.0
10	1362+16.907	1	204	49.2	49.5	0.0	49.3	70	5.3	0.0
11	1366+04.852	1	204	48.8	49.0	0.0	48.8	70	5.3	0.0
12	1369+92.797	1	204	48.8	49.0	0.0	48.8	70	5.3	0.0
13	1373+80.741	1	204	50.1	50.6	0.0	50.2	69	5.3	0.0
14	1377+68.686	1	204	54.1	54.8	0.0	54.1	70	5.1	0.0
15	1381+56.631	1	204	56.0	57.4	0.0	56.2	70	5.2	1.0
16	1385+44.576	1	204	56.8	58.2	0.0	56.9	69	5.0	1.0
17	1389+32.521	1	204	57.5	59.2	0.0	57.7	69	5.0	1.0
18	1393+20.465	1	204	58.0	59.4	0.0	58.2	70	5.2	2.0
19	1397+08.410	1	204	57.8	59.3	0.0	58.0	70	5.2	5.0
20	1400+96.355	1	204	57.5	58.8	0.0	57.6	70	5.2	0.0
21	1404+84.300	1	204	57.1	58.2	0.0	57.2	69	5.4	0.0
22	1408+72.244	1	204	54.8	55.0	0.0	54.9	69	5.5	0.0
23	1412+60.189	1	204	51.2	52.0	0.0	51.3	68	5.5	0.0
24	1416+48.134	1	204	49.7	51.3	0.0	49.9	68	5.6	0.0
25	1420+36.079	1	204	49.6	50.9	0.0	49.7	66	5.3	0.0
26	1424+24.024	1	204	52.7	54.8	0.0	53.0	66	5.3	0.0
27	1428+11.968	1	204	52.3	54.5	0.0	52.6	66	5.3	0.0
28	1431+99.913	1	204	49.6	50.9	0.0	49.8	67	5.4	0.0
29	1435+87.858	1	204	48.9	50.5	0.0	49.1	67	5.3	0.0
30	1439+75.803	1	204	49.5	49.5	0.0	49.5	68	5.6	0.0
31	1443+63.748	1	204	52.5	49.3	0.0	52.1	69	5.7	0.0
32	1447+51.692	1	204	53.9	52.0	0.0	53.7	70	5.9	0.0
33	1451+39.637	1	204	54.9	55.9	0.0	55.0	69	5.7	0.0
34	1455+27.582	1	204	55.1	57.6	0.0	55.4	69	5.7	0.0

Station Number	Station	Number of Lanes	Traffic Volume (vpd)	Speed Mean Cars (mph)	Speed Mean Trucks (mph)	Speed Mean RVs (mph)	Speed Mean All (mph)	Percent Following (%)	Platoon Size	Number of Passes
35	1459+15.527	1	204	52.7	53.7	0.0	52.8	70	5.6	0.0
36	1463+03.471	1	204	51.9	53.2	0.0	52.1	70	5.8	0.0
37	1466+91.416	1	204	53.3	54.6	0.0	53.5	70	5.8	0.0
38	1470+79.361	1	204	50.3	51.0	0.0	50.3	70	5.6	0.0
39	1474+67.306	1	204	49.4	50.5	0.0	49.5	70	5.6	0.0
40	1478+55.251	1	204	50.6	50.7	0.0	50.6	70	5.6	0.0
41	1482+43.195	1	203	53.1	52.1	0.0	53.0	71	5.7	1.0
42	1486+31.140	1	203	53.4	53.2	0.0	53.3	71	5.7	1.0
43	1490+19.085	1	202	49.8	51.0	0.0	49.9	72	5.7	0.0
44	1494+07.030	1	203	48.0	49.4	0.0	48.1	70	5.6	0.0
45	1497+94.975	1	204	47.4	48.8	0.0	47.5	71	5.5	0.0
46	1501+82.919	1	204	46.7	48.1	0.0	46.9	71	5.7	0.0
47	1505+70.864	1	204	46.8	48.0	0.0	47.0	71	5.7	0.0
48	1509+58.809	1	204	49.0	50.2	0.0	49.1	72	5.6	0.0
49	1513+46.754	1	204	46.6	47.7	0.0	46.8	72	5.8	0.0
50	1517+34.698	1	204	47.1	48.5	0.0	47.3	73	5.8	0.0
51	1521+22.643	1	204	51.7	52.8	0.0	51.8	74	5.8	0.0
52	1525+10.588	1	204	53.3	54.4	0.0	53.5	74	5.9	0.0
53	1528+98.533	1	204	52.7	53.5	0.0	52.8	74	5.9	0.0
54	1532+86.478	1	204	49.6	50.3	0.0	49.8	74	5.7	0.0
55	1536+74.422	1	204	48.6	49.8	0.0	48.8	74	5.5	0.0
56	1540+62.367	1	204	47.9	49.2	0.0	48.1	74	5.5	0.0
57	1544+50.312	1	204	47.7	48.8	0.0	47.9	74	5.5	0.0
58	1548+38.257	1	203	50.3	49.2	0.0	50.2	75	5.9	0.0
59	1552+26.202	1	203	52.2	50.0	0.0	52.0	75	5.9	2.0
60	1556+14.146	1	203	52.4	50.7	0.0	52.2	75	5.9	0.0
61	1560+02.091	1	203	51.0	50.4	0.0	50.9	74	5.7	0.0
62	1563+90.036	1	203	47.8	48.6	0.0	47.9	73	5.5	0.0
63	1567+77.981	1	203	47.5	48.8	0.0	47.7	72	5.5	0.0
64	1571+65.925	1	203	47.3	49.0	0.0	47.5	72	5.5	0.0
65	1575+53.870	1	203	47.7	49.2	0.0	47.9	73	5.8	0.0
66	1579+41.815	1	204	47.0	48.7	0.0	47.2	73	5.7	0.0
67	1583+29.760	1	204	45.0	46.4	0.0	45.2	72	5.5	0.0
68	1587+17.705	1	204	45.2	46.4	0.0	45.3	74	5.8	0.0
69	1591+05.649	1	204	46.6	48.3	0.0	46.8	73	5.7	0.0
70	1594+93.594	1	202	44.6	45.7	0.0	44.7	73	5.8	0.0
71	1598+81.539	1	201	43.8	45.2	0.0	44.0	73	5.7	0.0
72	1602+69.484	1	201	43.7	44.9	0.0	43.8	73	5.6	0.0
73	1606+57.428	1	201	46.6	48.5	0.0	46.8	73	5.7	0.0
74	1610+45.373	1	201	45.8	47.0	0.0	46.0	73	5.7	0.0
75	1614+33.318	1	201	46.6	48.1	0.0	46.8	74	6.1	0.0
76	1618+21.263	1	201	51.4	52.8	0.0	51.6	74	6.1	1.0
77	1622+09.208	1	201	53.0	54.1	0.0	53.1	74	6.1	0.0
78	1625+97.152	1	201	52.0	53.2	0.0	52.2	73	5.7	0.0
79	1629+85.097	1	201	51.7	52.5	0.0	51.8	73	5.7	0.0
80	1633+73.042	1	201	51.8	51.5	0.0	51.8	73	5.7	0.0
81	1637+60.987	1	201	52.9	50.7	0.0	52.6	73	5.7	0.0
82	1641+48.932	1	201	52.4	49.8	0.0	52.1	75	6.2	0.0
83	1645+36.876	1	201	49.8	48.4	0.0	49.6	74	6.1	0.0
84	1649+24.821	1	200	48.7	47.5	0.0	48.5	74	6.1	0.0

Station Number	Station	Number of Lanes	Traffic Volume (vpd)	Speed Mean Cars (mph)	Speed Mean Trucks (mph)	Speed Mean RVs (mph)	Speed Mean All (mph)	Percent Following (%)	Platoon Size	Number of Passes
85	1653+12.766	1	200	48.0	46.7	0.0	47.8	72	5.3	0.0
86	1657+00.711	1	200	47.1	46.2	0.0	47.0	74	5.5	0.0
87	1660+88.655	1	203	47.5	46.9	0.0	47.5	74	5.5	0.0
88	1664+76.600	1	207	50.5	49.0	0.0	50.3	75	5.7	0.0
89	1668+64.545	1	210	52.0	51.0	0.0	51.9	75	5.7	1.0
90	1672+52.490	1	210	52.2	52.0	0.0	52.2	75	5.8	0.0
91	1676+40.435	1	210	50.2	50.7	0.0	50.3	75	5.8	0.0
92	1680+28.379	1	210	49.8	50.5	0.0	49.9	74	5.7	0.0
93	1684+16.324	1	210	49.6	50.3	0.0	49.7	74	5.9	0.0
94	1688+04.269	1	210	50.7	50.7	0.0	50.7	74	5.9	0.0
95	1691+92.214	1	210	48.8	49.7	0.0	49.0	74	5.6	0.0
96	1695+80.159	1	210	48.2	49.2	0.0	48.3	74	5.6	0.0
97	1699+68.103	1	210	51.1	51.3	0.0	51.1	75	5.7	0.0
98	1703+56.048	1	210	51.8	52.7	0.0	52.0	76	5.7	0.0
99	1707+43.993	1	210	52.0	52.7	0.0	52.0	76	5.8	0.0
100	1711+31.938	1	210	52.2	53.8	0.0	52.4	76	6.0	0.0
101	1715+19.882	1	210	53.6	55.8	0.0	53.9	75	5.7	3.0
102	1719+07.827	1	210	55.0	56.6	0.0	55.2	75	5.7	1.0
103	1722+95.772	1	209	55.3	56.6	0.0	55.5	75	5.6	0.0
104	1726+83.717	1	207	55.4	56.7	0.0	55.5	75	5.7	0.0
105	1730+71.662	1	207	53.4	54.5	0.0	53.5	75	5.7	0.0
106	1734+59.606	1	207	51.0	51.9	0.0	51.1	75	5.6	0.0
107	1738+47.551	1	207	52.2	53.4	0.0	52.4	75	5.8	0.0
108	1742+35.496	1	207	53.5	55.3	0.0	53.8	74	5.8	0.0
109	1746+23.441	1	207	53.4	55.0	0.0	53.7	75	5.8	0.0
110	1750+11.386	1	207	50.7	51.9	0.0	50.9	75	5.8	0.0
111	1753+99.330	1	207	49.1	50.5	0.0	49.3	75	5.9	0.0
112	1757+87.275	1	207	49.6	48.6	0.0	49.5	75	5.9	0.0
113	1761+75.220	1	207	51.0	47.5	0.0	50.5	75	5.9	0.0
114	1765+63.165	1	207	53.1	49.8	0.0	52.6	75	5.8	0.0
115	1769+51.109	1	207	55.4	54.1	0.0	55.2	76	5.9	0.0
116	1773+39.054	1	206	56.9	57.1	0.0	56.9	76	5.9	0.0
117	1777+26.999	1	206	57.9	58.3	0.0	58.0	75	5.6	5.0
118	1781+14.944	1	206	58.5	58.7	0.0	58.5	75	5.4	7.0
119	1785+02.889	1	206	58.5	58.8	0.0	58.6	74	5.5	5.0
120	1788+90.833	1	206	58.2	58.5	0.0	58.2	74	5.4	5.0
121	1792+78.778	1	206	57.8	57.8	0.0	57.8	74	5.3	1.0
122	1796+66.723	1	206	57.3	57.3	0.0	57.3	73	5.4	0.0
123	1800+54.668	1	206	56.9	56.6	0.0	56.9	72	5.3	0.0
124	1804+42.613	1	206	56.5	56.3	0.0	56.5	72	5.1	0.0
125	1808+30.557	1	206	56.3	56.1	0.0	56.3	72	5.2	0.0
126	1812+18.502	1	206	55.5	55.4	0.0	55.5	72	5.5	0.0
127	1816+06.447	1	206	50.9	50.0	0.0	50.7	72	5.3	0.0
128	1819+94.392	1	206	49.6	48.9	0.0	49.5	72	5.3	0.0
129	1823+82.336	1	206	51.0	50.7	0.0	50.9	72	5.1	0.0
130	1827+70.281	1	206	49.4	49.7	0.0	49.4	71	5.2	0.0
131	1831+58.226	1	206	50.7	51.5	0.0	50.9	72	5.3	0.0
132	1835+46.171	1	206	50.2	50.7	0.0	50.3	72	5.3	0.0
133	1839+34.116	1	203	47.7	48.0	0.0	47.7	72	5.6	0.0
134	1843+22.060	1	202	46.8	47.1	0.0	46.9	72	5.4	0.0

Station Number	Station	Number of Lanes	Traffic Volume (vpd)	Speed Mean Cars (mph)	Speed Mean Trucks (mph)	Speed Mean RVs (mph)	Speed Mean All (mph)	Percent Following (%)	Platoon Size	Number of Passes
135	1847+10.005	1	200	48.5	48.8	0.0	48.5	72	5.7	0.0
136	1850+97.950	1	199	45.2	44.8	0.0	45.1	72	5.7	0.0
137	1854+85.895	1	199	44.0	43.7	0.0	44.0	72	5.8	0.0
138	1858+73.839	1	197	46.8	46.7	0.0	46.8	73	6.0	0.0
139	1862+61.784	1	199	51.7	51.9	0.0	51.8	73	5.8	0.0
140	1866+49.729	1	199	52.6	53.0	0.0	52.6	73	5.8	0.0
141	1870+37.674	1	199	50.0	49.6	0.0	50.0	72	5.7	0.0
142	1874+25.619	1	199	50.0	49.1	0.0	49.8	73	5.7	0.0
143	1878+13.563	1	199	53.3	53.0	0.0	53.3	73	5.9	0.0
144	1882+01.508	1	200	55.2	55.3	0.0	55.2	74	6.1	0.0
145	1885+89.453	1	200	56.0	56.0	0.0	56.0	74	6.1	1.0
146	1889+77.398	1	199	56.3	55.4	0.0	56.1	74	6.1	7.0
147	1893+65.343	1	201	56.0	55.0	0.0	55.8	73	5.6	2.0
148	1897+53.287	1	203	56.0	54.5	0.0	55.8	72	5.5	1.0
149	1901+41.232	1	206	54.8	53.3	0.0	54.6	72	5.5	0.0
150	1905+29.177	1	208	51.5	50.0	0.0	51.3	70	5.6	0.0
151	1909+17.122	1	208	51.3	49.6	0.0	51.1	70	6.0	0.0
152	1913+05.066	1	208	49.8	48.2	0.0	49.5	70	5.9	0.0
153	1916+93.011	1	208	48.6	46.9	0.0	48.3	70	5.9	0.0
154	1920+80.956	1	208	48.8	46.8	0.0	48.5	70	5.9	0.0
155	1924+68.901	1	208	52.1	49.6	0.0	51.8	71	5.9	0.0
156	1928+56.846	1	208	55.2	52.8	0.0	54.9	71	6.5	2.0
157	1932+44.790	1	208	56.5	54.5	0.0	56.3	71	6.5	2.0
158	1936+32.735	1	208	56.9	55.2	0.0	56.7	71	6.5	2.0
159	1940+20.680	1	208	57.1	55.7	0.0	56.9	71	6.3	2.0
160	1944+08.625	1	208	57.1	55.0	0.0	56.8	71	6.3	4.0
161	1947+96.570	1	208	56.8	53.1	0.0	56.3	70	6.2	2.0
162	1951+84.514	1	208	56.3	51.6	0.0	55.7	70	6.4	0.0
163	1955+72.459	1	208	56.6	52.3	0.0	56.0	69	6.1	0.0
164	1959+60.404	1	208	57.0	53.0	0.0	56.5	68	6.0	3.0
165	1963+48.349	1	208	57.3	53.7	0.0	56.8	66	5.8	4.0
166	1967+36.293	1	208	58.1	54.0	0.0	57.5	66	5.4	3.0
167	1971+24.238	1	208	58.8	54.5	0.0	58.2	65	5.1	5.0
168	1975+12.183	1	208	59.3	55.0	0.0	58.7	65	5.2	5.0
169	1979+00.128	1	208	59.5	55.2	0.0	58.8	65	5.1	4.0
170	1982+88.073	1	208	59.2	55.4	0.0	58.6	65	5.3	7.0
171	1986+76.017	1	208	58.5	55.6	0.0	58.1	65	5.2	6.0
172	1990+63.962	1	208	57.7	55.0	0.0	57.3	66	5.2	0.0
173	1994+51.907	1	208	56.5	52.8	0.0	56.0	65	5.1	1.0
174	1998+39.852	1	208	55.0	49.8	0.0	54.3	64	4.9	1.0
175	2002+27.797	1	208	53.9	47.0	0.0	52.9	62	4.9	0.0
176	2006+15.741	1	208	52.9	44.5	0.0	51.8	61	4.9	0.0
177	2010+03.686	1	208	52.6	44.1	0.0	51.5	59	4.6	0.0
178	2013+91.631	1	208	53.3	46.0	0.0	52.3	60	4.7	0.0
179	2017+79.576	1	208	54.9	49.6	0.0	54.1	62	5.0	0.0
180	2021+67.520	1	208	56.4	53.7	0.0	56.0	62	4.8	0.0
181	2025+55.465	1	208	57.5	57.6	0.0	57.5	62	4.7	0.0
182	2029+43.410	1	208	58.5	59.3	0.0	58.6	61	4.8	2.0
183	2033+31.355	1	208	59.0	59.5	0.0	59.1	61	4.7	2.0
184	2037+19.300	1	208	59.3	59.5	0.0	59.3	62	4.8	3.0



Station Number	Station	Number of Lanes	Traffic Volume (vpd)	Speed Mean Cars (mph)	Speed Mean Trucks (mph)	Speed Mean RVs (mph)	Speed Mean All (mph)	Percent Following (%)	Platoon Size	Number of Passes
185	2041+07.244	1	209	59.7	59.5	0.0	59.6	60	4.7	8.0
186	2044+95.189	1	209	59.8	59.5	0.0	59.7	58	4.4	2.0
187	2048+83.134	1	209	59.7	59.5	0.0	59.7	58	4.3	2.0
188	2052+71.079	1	209	59.5	59.2	0.0	59.5	58	4.4	5.0
189	2056+59.024	1	209	59.2	58.9	0.0	59.2	58	4.4	1.0
190	2060+46.968	1	209	58.9	58.4	0.0	58.8	59	4.8	1.0
191	2064+34.913	1	209	58.6	57.6	0.0	58.4	59	4.6	0.0
192	2068+22.858	1	209	58.2	56.8	0.0	58.0	60	5.0	0.0
193	2072+10.803	1	209	57.8	56.3	0.0	57.6	60	4.9	0.0
194	2075+98.747	1	209	57.4	56.5	0.0	57.3	60	5.1	0.0
195	2079+86.692	1	209	57.7	56.8	0.0	57.6	60	5.1	0.0
196	2083+74.637	1	210	58.4	56.8	0.0	58.2	60	5.0	0.0
197	2087+62.582	1	211	59.1	57.7	0.0	58.9	59	4.8	0.0
198	2091+50.527	1	213	59.3	57.5	0.0	59.1	60	4.9	6.0
199	2095+38.471	1	213	59.3	57.3	0.0	59.0	61	4.9	7.0
200	2099+26.416	1	212	59.0	57.0	0.0	58.7	61	4.8	3.0
201	2103+14.361	1	212	58.7	56.9	0.0	58.4	61	4.7	5.0
202	2107+02.306	1	212	58.3	56.9	0.0	58.1	62	4.6	2.0
203	2110+90.250	1	212	58.0	56.7	0.0	57.8	61	4.7	1.0
204	2114+78.195	1	213	57.8	56.5	0.0	57.6	60	4.7	0.0
205	2118+66.140	1	214	57.9	56.3	0.0	57.7	60	4.8	0.0
206	2122+54.085	1	212	58.0	56.3	0.0	57.8	59	4.7	0.0
207	2126+42.030	1	211	58.0	56.0	0.0	57.7	59	4.7	0.0
208	2130+29.974	1	208	58.0	56.2	0.0	57.8	59	4.6	4.0
209	2134+17.919	1	206	57.8	56.2	0.0	57.5	59	4.5	0.0
210	2138+05.864	1	204	57.3	56.1	0.0	57.1	59	4.6	0.0
211	2141+93.809	1	203	57.0	56.0	0.0	56.9	59	4.4	0.0
212	2145+81.754	1	203	56.9	56.1	0.0	56.8	58	4.5	0.0
213	2149+69.698	1	200	56.9	56.3	0.0	56.8	57	4.3	0.0
214	2153+57.643	1	198	57.0	56.0	0.0	56.9	55	4.2	0.0
215	2157+45.588	1	197	57.2	56.3	0.0	57.1	55	4.1	0.0
216	2161+33.533	1	195	57.3	55.7	0.0	57.1	56	4.0	0.0
217	2165+21.477	1	191	57.4	55.6	0.0	57.1	56	4.0	0.0
218	2169+09.422	1	189	57.4	55.9	0.0	57.2	55	4.2	0.0
219	2172+97.367	1	190	57.3	55.4	0.0	57.0	56	4.2	0.0
220	2176+85.312	1	189	57.0	54.8	0.0	56.7	57	4.2	0.0
221	2180+73.257	1	189	56.9	54.6	0.0	56.5	57	4.3	0.0
222	2184+61.201	1	188	57.0	55.4	0.0	56.8	57	4.3	0.0
223	2188+49.146	1	187	57.2	56.4	0.0	57.1	58	4.2	0.0
224	2192+37.091	1	186	57.1	56.0	0.0	56.9	59	4.2	0.0
225	2196+25.036	1	185	57.0	55.4	0.0	56.8	58	4.3	0.0
226	2200+12.981	1	185	56.0	53.9	0.0	55.7	59	4.3	0.0
227	2204+00.925	1	185	52.6	50.5	0.0	52.4	59	4.3	0.0
228	2207+88.870	1	184	51.3	49.0	0.0	51.0	60	4.5	0.0
229	2211+76.815	1	185	52.2	48.5	0.0	51.6	61	4.8	0.0
230	2215+64.760	1	185	54.0	49.2	0.0	53.3	61	4.8	1.0
231	2219+52.704	1	185	54.2	50.1	0.0	53.6	60	4.6	0.0
232	2223+40.649	1	185	54.9	50.8	0.0	54.3	60	4.6	0.0
233	2227+28.594	1	185	56.3	52.5	0.0	55.8	60	4.5	0.0
234	2231+16.539	1	185	57.5	54.7	0.0	57.1	57	4.1	2.0

Station Number	Station	Number of Lanes	Traffic Volume (vpd)	Speed Mean Cars (mph)	Speed Mean Trucks (mph)	Speed Mean RVs (mph)	Speed Mean All (mph)	Percent Following (%)	Platoon Size	Number of Passes
235	2235+04.484	1	185	58.2	56.2	0.0	57.9	57	4.2	6.0
236	2238+92.428	1	183	58.3	56.7	0.0	58.1	57	4.2	4.0
237	2242+80.373	1	180	58.3	56.6	0.0	58.0	57	4.2	1.0
238	2246+68.318	1	178	58.0	55.6	0.0	57.6	56	4.0	0.0
239	2250+56.263	1	176	57.5	55.0	0.0	57.1	55	3.9	0.0
240	2254+44.208	1	174	53.5	51.9	0.0	53.3	52	3.9	0.0
241	2258+32.152	1	174	52.3	50.9	0.0	52.1	52	4.2	0.0
242	2262+20.097	1	175	51.5	50.3	0.0	51.3	51	4.2	0.0
243	2266+08.042	1	175	51.3	50.5	0.0	51.2	53	4.6	0.0
244	2269+95.987	1	175	54.8	53.3	0.0	54.6	54	4.5	0.0
245	2273+83.931	1	175	55.4	55.4	0.0	55.4	54	4.5	0.0
246	2277+71.876	1	177	51.9	51.5	0.0	51.8	54	4.3	0.0
247	2281+59.821	1	177	51.1	49.8	0.0	50.9	55	4.1	0.0
248	2285+47.766	1	177	50.7	49.2	0.0	50.5	55	4.3	0.0
249	2289+35.711	1	177	50.7	49.2	0.0	50.5	56	4.0	0.0
250	2293+23.655	1	177	51.1	49.2	0.0	50.8	56	4.0	0.0
251	2297+11.600	1	177	52.1	50.4	0.0	51.9	56	4.1	0.0
252	2300+99.545	1	178	55.6	52.2	0.0	55.1	56	4.1	3.0
253	2304+87.490	1	180	57.1	54.1	0.0	56.7	57	4.1	4.0
254	2308+75.435	1	179	57.6	55.4	0.0	57.3	58	4.2	2.0
255	2312+63.379	1	179	58.0	56.5	0.0	57.7	58	4.2	2.0
256	2316+51.324	1	179	58.1	57.1	0.0	58.0	57	4.2	0.0
257	2320+39.269	1	179	58.2	56.9	0.0	58.0	57	4.2	0.0
258	2324+27.214	1	180	55.7	54.2	0.0	55.4	55	4.1	0.0
259	2328+15.158	1	180	53.5	51.3	0.0	53.1	54	4.0	0.0
260	2332+03.103	1	180	52.4	49.2	0.0	52.0	54	4.2	0.0
261	2335+91.048	1	180	52.2	49.0	0.0	51.7	53	4.3	0.0
262	2339+78.993	1	180	56.0	51.4	0.0	55.3	52	4.1	0.0
263	2343+66.938	1	180	57.3	53.5	0.0	56.7	53	4.1	2.0
264	2347+54.882	1	180	58.0	55.2	0.0	57.5	54	4.4	2.0
265	2351+42.827	1	180	58.7	56.3	0.0	58.4	54	4.2	2.0
266	2355+30.772	1	180	59.1	57.3	0.0	58.8	53	4.1	4.0
267	2359+18.717	1	180	59.1	57.2	0.0	58.8	53	4.1	4.0
268	2363+06.661	1	180	59.0	56.7	0.0	58.6	54	4.1	3.0
269	2366+94.606	1	180	58.8	56.4	0.0	58.4	55	4.1	2.0
270	2370+82.551	1	181	58.7	56.8	0.0	58.4	55	4.2	1.0
271	2374+70.496	1	180	58.4	56.8	0.0	58.2	53	4.1	1.0
272	2378+58.441	1	180	58.3	56.7	0.0	58.0	53	4.2	0.0
273	2382+46.385	1	180	58.1	56.4	0.0	57.8	52	4.1	0.0
274	2386+34.330	1	180	57.3	55.5	0.0	57.0	52	4.1	0.0
275	2390+22.275	1	180	52.6	50.5	0.0	52.2	51	4.2	0.0
276	2394+10.220	1	180	51.7	49.0	0.0	51.3	52	4.2	0.0
277	2397+98.165	1	180	52.3	49.4	0.0	51.8	52	4.1	0.0
278	2401+86.109	1	179	49.1	47.7	0.0	48.9	52	4.1	0.0
279	2405+74.054	1	179	48.6	46.4	0.0	48.3	52	4.1	0.0
280	2409+61.999	1	179	48.7	46.3	0.0	48.3	53	4.2	0.0
281	2413+49.944	1	177	52.4	48.6	0.0	51.8	54	4.3	0.0
282	2417+37.888	1	177	49.2	47.3	0.0	49.0	54	4.1	0.0
283	2421+25.833	1	177	48.8	46.0	0.0	48.4	55	4.0	0.0
284	2425+13.778	1	177	48.4	46.0	0.0	48.1	55	4.2	0.0

Station Number	Station	Number of Lanes	Traffic Volume (vpd)	Speed Mean Cars (mph)	Speed Mean Trucks (mph)	Speed Mean RVs (mph)	Speed Mean All (mph)	Percent Following (%)	Platoon Size	Number of Passes
285	2429+01.723	1	177	52.7	48.9	0.0	52.1	56	4.2	0.0
286	2432+89.668	1	177	55.6	51.5	0.0	55.0	56	4.2	1.0
287	2436+77.612	1	177	56.5	53.6	0.0	56.1	57	4.3	0.0
288	2440+65.557	1	176	57.5	55.2	0.0	57.1	57	4.4	2.0
289	2444+53.502	1	177	58.2	56.3	0.0	57.9	56	4.2	1.0
290	2448+41.447	1	179	58.3	56.9	0.0	58.1	56	4.2	1.0
291	2452+29.392	1	179	58.2	57.3	0.0	58.0	58	4.1	0.0
292	2456+17.336	1	181	57.8	57.0	0.0	57.7	57	4.0	0.0
293	2460+05.281	1	181	53.6	52.1	0.0	53.3	58	4.1	0.0
294	2463+93.226	1	181	51.8	49.8	0.0	51.4	58	3.9	0.0
295	2467+81.171	1	181	52.3	50.2	0.0	52.0	57	3.9	0.0
296	2471+69.115	1	181	55.1	52.6	0.0	54.7	57	3.9	0.0
297	2475+57.060	1	181	55.8	54.1	0.0	55.5	58	4.1	0.0
298	2479+45.005	1	181	56.3	55.6	0.0	56.2	58	4.1	0.0
299	2483+32.950	1	181	57.1	56.6	0.0	57.1	57	4.0	0.0
300	2487+20.895	1	181	59.5	57.5	0.0	59.2	57	4.0	0.0

Table 6 below reports spot traffic operational data collected by the simulation at each data collection station for travel in direction of decreasing stations. These data are analogous to data that would be collected by a traffic data recorder placed at the specified location on the highway during the simulation time. The data include hourly traffic volume; measured mean speed of cars, trucks, and recreational vehicles; mean and standard deviation speed for all vehicles combined; percent of vehicles following at a headway of less than 4 seconds; the average platoon size; and number of passes. A separate table is produced for each direction of travel. The data in this station summary data tables are used to create graphs.

**Table 6. Station Summary (Decreasing)**

Station Number	Station	Number of Lanes	Traffic Volume (vpd)	Speed Mean Cars (mph)	Speed Mean Trucks (mph)	Speed Mean RVs (mph)	Speed Mean All (mph)	Percent Following (%)	Platoon Size	Number of Passes
1	2487+20.895	1	87	61.7	61.0	0.0	61.6	56	4.5	0.0
2	2483+32.950	1	87	61.7	59.0	0.0	61.3	56	4.5	0.0
3	2479+45.005	1	85	61.1	57.4	0.0	60.5	55	4.4	0.0
4	2475+57.060	1	82	60.5	56.5	0.0	59.9	54	4.1	1.0
5	2471+69.115	1	80	60.3	56.3	0.0	59.7	51	3.7	1.0
6	2467+81.171	1	78	59.0	54.2	0.0	58.3	50	3.6	0.0
7	2463+93.226	1	76	55.8	50.5	0.0	55.0	50	3.7	2.0
8	2460+05.281	1	74	55.9	49.4	0.0	54.8	46	3.4	1.0
9	2456+17.336	1	72	59.3	50.9	0.0	58.0	46	3.5	3.0
10	2452+29.392	1	72	60.0	52.6	0.0	58.8	46	3.5	1.0
11	2448+41.447	1	71	60.1	54.1	0.0	59.1	46	3.5	0.0
12	2444+53.502	1	71	60.3	54.8	0.0	59.3	46	3.5	0.0
13	2440+65.557	1	71	60.6	55.2	0.0	59.7	46	3.5	0.0
14	2436+77.612	1	71	61.0	55.7	0.0	60.1	45	3.5	1.0
15	2432+89.668	1	71	61.0	56.1	0.0	60.1	42	3.3	1.0
16	2429+01.723	1	71	60.7	56.3	0.0	59.9	42	3.3	0.0

Station Number	Station	Number of Lanes	Traffic Volume (vpd)	Speed Mean Cars (mph)	Speed Mean Trucks (mph)	Speed Mean RVs (mph)	Speed Mean All (mph)	Percent Following (%)	Platoon Size	Number of Passes
17	2425+13.778	1	72	54.5	48.9	0.0	53.5	43	3.6	2.0
18	2421+25.833	1	72	54.1	47.7	0.0	53.0	40	3.4	0.0
19	2417+37.888	1	72	53.9	46.6	0.0	52.6	38	3.1	0.0
20	2413+49.944	1	73	57.3	49.8	0.0	56.0	38	3.3	1.0
21	2409+61.999	1	73	54.2	48.0	0.0	53.1	40	3.4	0.0
22	2405+74.054	1	74	53.6	47.9	0.0	52.6	38	3.5	1.0
23	2401+86.109	1	74	53.5	48.1	0.0	52.6	36	3.5	0.0
24	2397+98.165	1	74	55.5	48.5	0.0	54.3	34	3.1	0.0
25	2394+10.220	1	74	56.7	49.8	0.0	55.4	34	3.1	0.0
26	2390+22.275	1	74	55.5	48.1	0.0	54.2	35	3.2	1.0
27	2386+34.330	1	74	58.2	49.8	0.0	56.7	36	3.5	0.0
28	2382+46.385	1	74	60.5	53.1	0.0	59.3	35	3.6	1.0
29	2378+58.441	1	74	60.8	54.8	0.0	59.7	36	3.5	0.0
30	2374+70.496	1	74	61.0	55.8	0.0	60.1	36	3.5	0.0
31	2370+82.551	1	74	61.4	56.1	0.0	60.4	36	3.5	0.0
32	2366+94.606	1	74	61.8	56.5	0.0	60.8	35	3.2	1.0
33	2363+06.661	1	74	62.0	56.9	0.0	61.2	36	3.5	0.0
34	2359+18.717	1	74	62.0	57.1	0.0	61.2	36	3.5	2.0
35	2355+30.772	1	74	62.0	56.6	0.0	61.0	35	3.2	0.0
36	2351+42.827	1	74	61.8	55.8	0.0	60.8	35	3.2	1.0
37	2347+54.882	1	74	61.7	55.8	0.0	60.7	34	3.3	0.0
38	2343+66.938	1	74	61.6	55.4	0.0	60.5	32	3.0	0.0
39	2339+78.993	1	74	61.3	54.8	0.0	60.2	34	3.3	1.0
40	2335+91.048	1	74	58.1	51.4	0.0	56.9	34	3.3	0.0
41	2332+03.103	1	74	57.0	49.6	0.0	55.7	31	3.3	0.0
42	2328+15.158	1	74	57.1	48.8	0.0	55.7	30	3.2	0.0
43	2324+27.214	1	74	57.4	49.4	0.0	56.0	31	3.3	1.0
44	2320+39.269	1	74	61.3	52.8	0.0	59.8	31	3.3	0.0
45	2316+51.324	1	74	61.4	54.5	0.0	60.2	32	3.4	0.0
46	2312+63.379	1	75	61.6	55.4	0.0	60.5	31	3.6	0.0
47	2308+75.435	1	75	61.5	55.6	0.0	60.5	29	3.4	0.0
48	2304+87.490	1	74	61.4	56.0	0.0	60.5	31	3.3	0.0
49	2300+99.545	1	74	61.4	56.5	0.0	60.5	31	3.3	0.0
50	2297+11.600	1	77	57.3	51.5	0.0	56.3	32	3.3	0.0
51	2293+23.655	1	79	56.5	49.2	0.0	55.2	34	3.5	0.0
52	2289+35.711	1	79	56.3	49.1	0.0	55.0	34	3.5	0.0
53	2285+47.766	1	79	56.4	49.1	0.0	55.1	34	3.5	0.0
54	2281+59.821	1	80	56.5	48.8	0.0	55.2	34	3.3	0.0
55	2277+71.876	1	80	56.5	48.3	0.0	55.1	34	3.3	0.0
56	2273+83.931	1	80	57.7	47.4	0.0	55.9	34	3.3	1.0
57	2269+95.987	1	80	59.5	47.9	0.0	57.5	34	3.3	0.0
58	2266+08.042	1	80	56.5	47.9	0.0	55.0	35	3.3	1.0
59	2262+20.097	1	80	56.7	48.6	0.0	55.2	32	3.2	2.0
60	2258+32.152	1	80	56.5	48.8	0.0	55.2	34	3.3	0.0
61	2254+44.208	1	80	56.7	49.8	0.0	55.4	35	3.3	1.0
62	2250+56.263	1	80	59.4	52.6	0.0	58.2	34	3.3	1.0
63	2246+68.318	1	81	61.2	55.6	0.0	60.2	33	3.3	0.0
64	2242+80.373	1	83	61.1	57.0	0.0	60.4	35	3.2	0.0
65	2238+92.428	1	85	61.0	57.4	0.0	60.3	38	3.5	0.0
66	2235+04.484	1	85	61.0	57.6	0.0	60.4	40	3.6	0.0

Station Number	Station	Number of Lanes	Traffic Volume (vpd)	Speed Mean Cars (mph)	Speed Mean Trucks (mph)	Speed Mean RVs (mph)	Speed Mean All (mph)	Percent Following (%)	Platoon Size	Number of Passes
67	2231+16.539	1	85	61.2	57.8	0.0	60.6	40	3.6	0.0
68	2227+28.594	1	85	61.4	57.7	0.0	60.8	40	3.6	0.0
69	2223+40.649	1	84	61.2	57.1	0.0	60.5	42	3.9	2.0
70	2219+52.704	1	84	61.2	56.9	0.0	60.4	42	3.9	0.0
71	2215+64.760	1	84	61.0	56.5	0.0	60.2	42	3.9	0.0
72	2211+76.815	1	84	60.3	55.5	0.0	59.5	39	4.0	1.0
73	2207+88.870	1	84	56.5	51.3	0.0	55.6	37	4.1	0.0
74	2204+00.925	1	84	56.0	51.1	0.0	55.2	38	4.2	0.0
75	2200+12.981	1	84	56.9	51.5	0.0	56.0	39	4.0	0.0
76	2196+25.036	1	84	59.1	52.8	0.0	58.0	38	3.9	1.0
77	2192+37.091	1	84	59.3	52.8	0.0	58.2	38	3.9	0.0
78	2188+49.146	1	84	59.3	52.2	0.0	58.0	38	3.9	0.0
79	2184+61.201	1	84	59.3	52.0	0.0	58.0	38	3.9	1.0
80	2180+73.257	1	84	59.7	53.7	0.0	58.6	38	3.9	0.0
81	2176+85.312	1	84	60.2	55.9	0.0	59.5	38	3.9	0.0
82	2172+97.367	1	85	60.4	57.0	0.0	59.8	39	4.0	0.0
83	2169+09.422	1	85	60.5	57.5	0.0	60.0	39	4.0	1.0
84	2165+21.477	1	85	60.5	57.5	0.0	60.0	38	3.7	0.0
85	2161+33.533	1	85	60.5	57.3	0.0	59.9	38	3.7	0.0
86	2157+45.588	1	85	60.4	57.1	0.0	59.9	39	3.5	0.0
87	2153+57.643	1	85	60.3	56.8	0.0	59.7	36	3.6	0.0
88	2149+69.698	1	85	60.3	56.1	0.0	59.5	36	3.6	0.0
89	2145+81.754	1	85	60.1	55.4	0.0	59.3	36	3.6	0.0
90	2141+93.809	1	84	59.9	54.5	0.0	59.0	36	3.5	0.0
91	2138+05.864	1	84	60.0	55.3	0.0	59.2	36	3.5	0.0
92	2134+17.919	1	84	60.0	55.7	0.0	59.3	36	3.5	0.0
93	2130+29.974	1	84	59.9	55.8	0.0	59.3	36	3.5	0.0
94	2126+42.030	1	84	60.0	55.6	0.0	59.3	37	3.4	0.0
95	2122+54.085	1	84	60.1	55.2	0.0	59.3	37	3.4	1.0
96	2118+66.140	1	84	60.1	55.4	0.0	59.3	37	3.4	0.0
97	2114+78.195	1	84	60.1	56.5	0.0	59.5	37	3.4	0.0
98	2110+90.250	1	84	60.4	57.0	0.0	59.9	36	3.3	0.0
99	2107+02.306	1	84	60.5	56.9	0.0	59.9	36	3.3	0.0
100	2103+14.361	1	84	60.5	56.9	0.0	59.9	36	3.5	0.0
101	2099+26.416	1	84	60.5	56.5	0.0	59.9	37	3.4	0.0
102	2095+38.471	1	84	60.3	56.0	0.0	59.7	37	3.6	0.0
103	2091+50.527	1	84	59.9	55.6	0.0	59.2	37	3.6	0.0
104	2087+62.582	1	84	59.7	54.8	0.0	58.9	37	3.6	0.0
105	2083+74.637	1	84	59.7	54.8	0.0	58.9	38	3.7	0.0
106	2079+86.692	1	84	59.9	55.4	0.0	59.2	38	3.7	1.0
107	2075+98.747	1	84	60.1	56.0	0.0	59.4	38	3.7	0.0
108	2072+10.803	1	84	60.2	56.2	0.0	59.5	37	3.4	2.0
109	2068+22.858	1	84	60.3	56.5	0.0	59.7	38	3.7	0.0
110	2064+34.913	1	85	60.6	56.5	0.0	59.9	36	3.6	0.0
111	2060+46.968	1	85	60.6	56.7	0.0	60.0	38	3.7	0.0
112	2056+59.024	1	85	61.0	57.3	0.0	60.4	39	4.0	1.0
113	2052+71.079	1	85	61.2	57.6	0.0	60.5	39	4.0	0.0
114	2048+83.134	1	85	61.3	57.1	0.0	60.6	38	3.9	0.0
115	2044+95.189	1	85	61.0	56.2	0.0	60.3	38	3.9	1.0
116	2041+07.244	1	85	60.5	54.8	0.0	59.7	39	4.0	0.0



Station Number	Station	Number of Lanes	Traffic Volume (vpd)	Speed Mean Cars (mph)	Speed Mean Trucks (mph)	Speed Mean RVs (mph)	Speed Mean All (mph)	Percent Following (%)	Platoon Size	Number of Passes
117	2037+19.300	1	85	59.3	52.0	0.0	58.2	42	4.0	2.0
118	2033+31.355	1	85	57.7	49.0	0.0	56.3	42	4.0	0.0
119	2029+43.410	1	85	56.3	46.2	0.0	54.5	41	3.9	2.0
120	2025+55.465	1	85	55.6	43.8	0.0	53.7	38	3.7	0.0
121	2021+67.520	1	86	56.3	42.7	0.0	54.1	35	3.5	0.0
122	2017+79.576	1	86	57.6	45.1	0.0	55.6	36	3.6	2.0
123	2013+91.631	1	86	58.6	48.4	0.0	56.9	36	3.6	2.0
124	2010+03.686	1	86	59.7	52.6	0.0	58.5	35	3.3	0.0
125	2006+15.741	1	86	60.3	56.1	0.0	59.7	35	3.5	3.0
126	2002+27.797	1	86	60.5	58.0	0.0	60.1	35	3.5	0.0
127	1998+39.852	1	86	60.5	58.6	0.0	60.2	35	3.1	0.0
128	1994+51.907	1	85	60.5	58.8	0.0	60.3	35	3.1	0.0
129	1990+63.962	1	85	60.9	59.0	0.0	60.6	32	3.1	0.0
130	1986+76.017	1	85	60.9	59.2	0.0	60.6	33	3.1	3.0
131	1982+88.073	1	85	60.9	59.1	0.0	60.6	35	3.3	0.0
132	1979+00.128	1	85	60.8	57.9	0.0	60.3	35	3.3	1.0
133	1975+12.183	1	84	60.9	57.5	0.0	60.3	37	3.1	0.0
134	1971+24.238	1	84	61.2	57.2	0.0	60.6	37	3.1	1.0
135	1967+36.293	1	84	61.2	57.1	0.0	60.5	37	3.1	3.0
136	1963+48.349	1	84	61.0	56.9	0.0	60.3	37	3.1	0.0
137	1959+60.404	1	80	61.6	56.8	0.0	60.8	32	2.9	1.0
138	1955+72.459	1	78	61.4	58.2	0.0	61.0	31	2.7	3.0
139	1951+84.514	1	77	61.3	59.0	0.0	61.0	31	2.9	0.0
140	1947+96.570	1	76	61.1	58.7	0.0	60.8	30	2.9	0.0
141	1944+08.625	1	76	61.2	58.6	0.0	60.8	32	3.0	1.0
142	1940+20.680	1	77	61.0	58.8	0.0	60.7	31	3.4	0.0
143	1936+32.735	1	77	61.0	58.8	0.0	60.7	30	3.6	1.0
144	1932+44.790	1	77	61.0	58.7	0.0	60.7	31	3.4	0.0
145	1928+56.846	1	77	60.8	58.7	0.0	60.5	30	3.6	0.0
146	1924+68.901	1	77	60.2	57.8	0.0	59.9	30	3.6	1.0
147	1920+80.956	1	77	55.7	52.4	0.0	55.3	29	3.0	0.0
148	1916+93.011	1	77	55.1	52.2	0.0	54.8	31	3.2	0.0
149	1913+05.066	1	77	55.2	52.2	0.0	54.8	30	2.9	1.0
150	1909+17.122	1	77	57.7	52.4	0.0	57.1	31	2.7	1.0
151	1905+29.177	1	77	54.6	51.5	0.0	54.3	31	2.9	0.0
152	1901+41.232	1	77	56.5	51.2	0.0	55.8	32	3.1	0.0
153	1897+53.287	2	77	60.0	51.1	0.0	58.6	10	2.3	0.0
154	1893+65.343	2	77	60.7	51.1	0.0	59.3	18	2.8	0.0
155	1889+77.398	2	77	60.7	50.5	0.0	59.3	18	2.2	2.0
156	1885+89.453	2	78	60.7	50.5	0.0	59.3	19	2.4	4.0
157	1882+01.508	2	78	60.7	50.5	0.0	59.3	22	2.4	3.0
158	1878+13.563	2	78	60.7	49.1	0.0	59.3	22	2.3	0.0
159	1874+25.619	2	77	55.9	47.7	0.0	55.2	17	2.3	3.0
160	1870+37.674	2	77	55.9	47.7	0.0	55.2	16	2.2	4.0
161	1866+49.729	2	77	58.6	47.0	0.0	57.3	21	2.1	4.0
162	1862+61.784	2	77	60.0	47.0	0.0	58.0	22	2.2	1.0
163	1858+73.839	2	77	54.5	46.4	0.0	53.9	18	2.1	3.0
164	1854+85.895	2	78	51.1	45.0	0.0	50.5	18	2.1	2.0
165	1850+97.950	2	78	51.1	45.0	0.0	50.5	18	2.2	5.0
166	1847+10.005	2	78	54.5	45.7	0.0	53.2	17	2.1	2.0

Station Number	Station	Number of Lanes	Traffic Volume (vpd)	Speed Mean Cars (mph)	Speed Mean Trucks (mph)	Speed Mean RVs (mph)	Speed Mean All (mph)	Percent Following (%)	Platoon Size	Number of Passes
167	1843+22.060	2	78	53.9	45.7	0.0	53.2	15	2.1	3.0
168	1839+34.116	2	78	53.9	45.7	0.0	53.2	18	2.2	4.0
169	1835+46.171	2	78	55.2	45.0	0.0	53.9	18	2.3	0.0
170	1831+58.226	2	78	57.3	44.3	0.0	55.9	17	2.3	1.0
171	1827+70.281	2	77	55.9	45.7	0.0	55.2	17	2.6	0.0
172	1823+82.336	2	76	57.3	46.4	0.0	56.6	17	2.6	0.0
173	1819+94.392	2	75	56.6	47.7	0.0	55.9	13	2.1	1.0
174	1816+06.447	2	70	55.9	46.4	0.0	54.5	10	2.0	2.0
175	1812+18.502	2	70	57.3	45.7	0.0	55.9	10	2.2	3.0
176	1808+30.557	2	70	59.3	45.0	0.0	58.0	10	2.0	1.0
177	1804+42.613	2	70	60.0	45.7	0.0	58.6	14	2.3	1.0
178	1800+54.668	2	71	60.7	48.4	0.0	60.0	14	2.4	1.0
179	1796+66.723	2	71	61.4	51.8	0.0	60.7	16	2.6	1.0
180	1792+78.778	2	71	61.4	53.9	0.0	60.7	17	2.7	0.0
181	1788+90.833	2	71	62.0	55.2	0.0	61.4	17	2.7	1.0
182	1785+02.889	2	71	61.4	55.2	0.0	60.7	18	2.3	1.0
183	1781+14.944	2	71	61.4	53.2	0.0	60.0	14	2.1	1.0
184	1777+26.999	2	71	60.7	51.1	0.0	59.3	14	2.4	2.0
185	1773+39.054	2	71	60.0	49.8	0.0	59.3	11	2.6	1.0
186	1769+51.109	2	71	60.0	48.4	0.0	58.6	13	2.5	2.0
187	1765+63.165	2	71	60.7	49.8	0.0	60.0	11	2.3	4.0
188	1761+75.220	2	71	61.4	53.2	0.0	60.7	8	2.0	0.0
189	1757+87.275	2	72	61.4	56.6	0.0	60.7	19	2.8	0.0
190	1753+99.330	1	72	56.9	53.5	0.0	56.5	18	2.9	0.0
191	1750+11.386	1	72	56.7	53.5	0.0	56.4	14	2.1	0.0
192	1746+23.441	1	73	60.9	54.1	0.0	60.1	14	2.1	0.0
193	1742+35.496	1	73	60.6	51.8	0.0	59.7	14	2.1	0.0
194	1738+47.551	2	73	60.0	49.1	0.0	58.6	7	2.0	0.0
195	1734+59.606	2	73	56.6	47.0	0.0	55.2	4	2.0	0.0
196	1730+71.662	2	73	56.6	45.7	0.0	55.9	6	2.0	0.0
197	1726+83.717	2	74	60.0	45.7	0.0	58.0	5	2.0	0.0
198	1722+95.772	2	74	61.4	48.4	0.0	60.0	5	2.0	1.0
199	1719+07.827	2	74	61.4	51.1	0.0	60.7	5	2.0	1.0
200	1715+19.882	2	75	61.4	51.8	0.0	60.7	7	2.0	0.0
201	1711+31.938	2	75	59.3	50.5	0.0	58.0	5	2.0	1.0
202	1707+43.993	2	75	59.3	50.5	0.0	58.0	7	2.0	1.0
203	1703+56.048	2	75	59.3	51.8	0.0	58.0	5	2.0	0.0
204	1699+68.103	2	76	61.4	53.9	0.0	60.7	7	2.0	1.0
205	1695+80.159	2	76	57.3	52.5	0.0	56.6	4	2.0	1.0
206	1691+92.214	2	76	57.3	52.5	0.0	56.6	5	2.0	1.0
207	1688+04.269	2	76	59.3	53.9	0.0	58.6	12	2.0	1.0
208	1684+16.324	2	76	57.3	51.8	0.0	56.6	17	2.1	1.0
209	1680+28.379	1	76	56.9	52.8	0.0	56.3	18	2.3	1.0
210	1676+40.435	1	76	56.7	53.3	0.0	56.3	17	2.3	0.0
211	1672+52.490	1	76	59.5	56.0	0.0	59.0	17	2.3	0.0
212	1668+64.545	1	76	61.0	58.2	0.0	60.7	18	2.4	0.0
213	1664+76.600	1	77	61.2	58.9	0.0	61.0	18	2.4	1.0
214	1660+88.655	1	78	56.9	53.3	0.0	56.5	18	2.4	0.0
215	1657+00.711	1	78	56.9	53.3	0.0	56.4	17	2.4	1.0
216	1653+12.766	1	78	56.7	53.3	0.0	56.3	18	2.4	1.0

Station Number	Station	Number of Lanes	Traffic Volume (vpd)	Speed Mean Cars (mph)	Speed Mean Trucks (mph)	Speed Mean RVs (mph)	Speed Mean All (mph)	Percent Following (%)	Platoon Size	Number of Passes
217	1649+24.821	1	78	56.5	53.3	0.0	56.1	17	2.4	0.0
218	1645+36.876	1	78	56.7	53.3	0.0	56.3	15	2.3	0.0
219	1641+48.932	1	78	59.7	56.3	0.0	59.3	17	2.3	0.0
220	1637+60.987	1	77	61.4	58.9	0.0	61.1	18	2.3	0.0
221	1633+73.042	1	77	59.0	55.6	0.0	58.6	17	2.3	0.0
222	1629+85.097	1	77	59.1	55.6	0.0	58.6	17	2.3	1.0
223	1625+97.152	1	77	59.2	55.6	0.0	58.7	16	2.1	2.0
224	1622+09.208	1	77	60.8	56.3	0.0	60.1	18	2.1	0.0
225	1618+21.263	1	77	61.6	57.9	0.0	61.1	17	2.1	0.0
226	1614+33.318	1	78	54.2	50.1	0.0	53.7	15	2.1	0.0
227	1610+45.373	1	78	53.3	46.6	0.0	52.4	14	2.2	0.0
228	1606+57.428	2	78	54.5	43.0	0.0	52.5	8	2.2	0.0
229	1602+69.484	2	78	51.1	39.5	0.0	49.8	9	2.2	1.0
230	1598+81.539	2	78	51.1	38.2	0.0	49.1	10	2.1	3.0
231	1594+93.594	2	78	51.1	39.5	0.0	49.8	9	2.2	1.0
232	1591+05.649	2	78	52.5	40.9	0.0	51.1	8	2.2	1.0
233	1587+17.705	2	78	51.8	39.5	0.0	50.5	8	2.2	1.0
234	1583+29.760	2	78	51.1	37.5	0.0	49.8	9	2.2	1.0
235	1579+41.815	2	78	51.8	36.1	0.0	49.8	9	2.2	2.0
236	1575+53.870	2	78	53.2	35.5	0.0	50.5	8	2.2	0.0
237	1571+65.925	2	78	52.5	35.5	0.0	50.5	8	2.2	1.0
238	1567+77.981	2	78	53.9	38.9	0.0	51.8	9	2.2	0.0
239	1563+90.036	2	79	53.9	44.3	0.0	52.5	9	2.2	1.0
240	1560+02.091	2	79	57.3	49.1	0.0	56.6	13	2.1	0.0
241	1556+14.146	2	79	61.4	53.2	0.0	60.0	15	2.2	2.0
242	1552+26.202	1	79	61.5	56.0	0.0	60.8	14	2.2	0.0
243	1548+38.257	1	79	61.4	57.1	0.0	60.8	14	2.2	0.0
244	1544+50.312	1	79	55.8	51.4	0.0	55.2	14	2.2	0.0
245	1540+62.367	1	79	55.7	51.7	0.0	55.2	14	2.2	0.0
246	1536+74.422	1	79	55.7	51.6	0.0	55.2	15	2.3	0.0
247	1532+86.478	1	79	55.8	51.7	0.0	55.3	16	2.3	1.0
248	1528+98.533	1	79	58.6	54.3	0.0	58.0	15	2.2	0.0
249	1525+10.588	1	79	61.6	58.2	0.0	61.2	15	2.2	1.0
250	1521+22.643	1	79	61.6	58.5	0.0	61.2	15	2.2	0.0
251	1517+34.698	1	79	54.9	50.5	0.0	54.3	15	2.2	0.0
252	1513+46.754	1	79	54.7	49.4	0.0	54.0	19	2.3	0.0
253	1509+58.809	1	79	57.5	48.6	0.0	56.4	19	2.3	1.0
254	1505+70.864	1	79	54.8	47.7	0.0	53.9	18	2.2	1.0
255	1501+82.919	1	79	54.8	48.2	0.0	54.0	20	2.1	1.0
256	1497+94.975	1	79	54.8	49.8	0.0	54.1	18	2.1	1.0
257	1494+07.030	1	79	54.5	50.6	0.0	54.1	18	2.1	1.0
258	1490+19.085	1	79	54.8	50.9	0.0	54.3	19	2.1	1.0
259	1486+31.140	1	79	60.3	54.9	0.0	59.7	20	2.1	0.0
260	1482+43.195	1	79	61.3	57.5	0.0	60.8	22	2.1	0.0
261	1478+55.251	1	79	59.7	56.7	0.0	59.4	22	2.1	1.0
262	1474+67.306	1	79	56.4	52.6	0.0	55.9	22	2.1	1.0
263	1470+79.361	1	80	56.1	52.3	0.0	55.6	22	2.1	1.0
264	1466+91.416	1	80	58.3	51.9	0.0	57.5	21	2.1	0.0
265	1463+03.471	1	80	56.9	51.2	0.0	56.1	21	2.1	0.0
266	1459+15.527	1	80	56.0	50.7	0.0	55.4	19	2.1	0.0

Station Number	Station	Number of Lanes	Traffic Volume (vpd)	Speed Mean Cars (mph)	Speed Mean Trucks (mph)	Speed Mean RVs (mph)	Speed Mean All (mph)	Percent Following (%)	Platoon Size	Number of Passes
267	1455+27.582	1	80	59.5	50.5	0.0	58.4	18	2.2	0.0
268	1451+39.637	2	80	60.7	48.4	0.0	58.6	5	2.0	0.0
269	1447+51.692	2	81	60.0	49.1	0.0	58.6	12	2.3	0.0
270	1443+63.748	2	80	60.7	51.1	0.0	59.3	18	2.2	1.0
271	1439+75.803	1	79	57.9	53.7	0.0	57.3	18	2.2	0.0
272	1435+87.858	1	79	55.6	52.5	0.0	55.2	16	2.1	0.0
273	1431+99.913	1	79	55.5	52.6	0.0	55.2	14	2.1	0.0
274	1428+11.968	1	79	58.0	53.7	0.0	57.4	15	2.1	1.0
275	1424+24.024	1	80	60.9	55.0	0.0	60.1	16	2.1	0.0
276	1420+36.079	1	81	55.8	51.8	0.0	55.2	16	2.1	0.0
277	1416+48.134	1	81	55.7	50.0	0.0	55.0	15	2.1	0.0
278	1412+60.189	1	81	56.0	50.7	0.0	55.3	15	2.1	1.0
279	1408+72.244	1	81	57.4	53.7	0.0	56.9	15	2.1	2.0
280	1404+84.300	1	81	61.1	58.6	0.0	60.8	14	2.1	0.0
281	1400+96.355	1	81	61.1	58.8	0.0	60.8	12	2.1	0.0
282	1397+08.410	1	81	61.1	58.0	0.0	60.7	12	2.1	0.0
283	1393+20.465	1	81	61.1	56.9	0.0	60.5	11	2.1	0.0
284	1389+32.521	1	81	61.1	56.0	0.0	60.4	9	2.2	0.0
285	1385+44.576	1	81	61.2	55.2	0.0	60.3	10	2.1	0.0
286	1381+56.631	1	81	61.2	54.5	0.0	60.3	11	2.1	0.0
287	1377+68.686	1	81	61.4	53.9	0.0	60.3	11	2.1	1.0
288	1373+80.741	1	81	57.3	51.5	0.0	56.5	10	2.1	0.0
289	1369+92.797	1	81	57.3	52.7	0.0	56.7	7	2.0	0.0
290	1366+04.852	1	81	57.2	53.3	0.0	56.7	7	2.0	2.0
291	1362+16.907	1	81	57.3	53.7	0.0	56.7	10	2.1	0.0
292	1358+28.962	1	81	59.7	55.2	0.0	59.0	12	2.4	0.0
293	1354+41.017	1	81	55.7	52.0	0.0	55.2	11	2.3	1.0
294	1350+53.073	1	80	55.7	52.0	0.0	55.2	11	2.3	0.0
295	1346+65.128	1	80	59.8	56.6	0.0	59.3	14	2.2	0.0
296	1342+77.183	1	80	56.8	53.4	0.0	56.3	12	2.3	0.0
297	1338+89.238	1	80	56.7	53.2	0.0	56.2	14	2.2	0.0
298	1335+01.294	1	82	58.6	54.2	0.0	58.0	15	2.2	0.0
299	1331+13.349	1	82	60.9	56.5	0.0	60.3	16	2.2	0.0
300	1327+25.404	1	82	61.2	57.3	0.0	60.7	16	2.2	0.0

*Interactive Highway Safety Design Model*

**Traffic Analysis Evaluation Report**

**P1 Alignment Alternative**

April 10, 2018





## **Disclaimer**

The Interactive Highway Design Model (IHSDM) software is disseminated under the sponsorship of the Department of Transportation in the interest of information exchange. The United States Government assumes no liability for its content or use thereof. This document does not constitute a standard, specification, or regulation.

The United States Government does not endorse products or manufacturers. Trade and manufacturers' names may appear in this software and documentation only because they are considered essential to the objective of the software.

## **Limited Warranty and Limitations of Remedies**

This software product is provided "as-is," without warranty of any kind-either expressed or implied (but not limited to the implied warranties of merchantability and fitness for a particular purpose). The FHWA do not warrant that the functions contained in the software will meet the end-user's requirements or that the operation of the software will be uninterrupted and error-free.

Under no circumstances will the FHWA be liable to the end-user for any damages or claimed lost profits, lost savings, or other incidental or consequential damages rising out of the use or inability to use the software (even if these organizations have been advised of the possibility of such damages), or for any claim by any other party.

## **Notice**

The use of the IHSDM software is being done strictly on a voluntary basis. In exchange for provision of IHSDM, the user agrees that the Federal Highway Administration (FHWA), U.S. Department of Transportation and any other agency of the Federal Government shall not be responsible for any errors, damage or other liability that may result from any and all use of the software, including installation and testing of the software. The user further agrees to hold the FHWA and the Federal Government harmless from any resulting liability. The user agrees that this hold harmless provision shall flow to any person to whom or any entity to which the user provides the IHSDM software. It is the user's full responsibility to inform any person to whom or any entity to which it provides the IHSDM software of this hold harmless provision.

---

---

## Table of Contents

<b>Report Overview</b> .....	<b>1</b>
<b>Traffic Analysis Graphical Results</b> .....	<b>2</b>
<b>Simulation Input Data</b> .....	<b>7</b>
<b>Simulation Output Summary</b> .....	<b>9</b>
<b>Simulation Station Summaries</b> .....	<b>10</b>

## List of Tables

Table Simulation Parameters .....	7
Table Random Number Generator Seeds .....	7
Table Traffic Input Data .....	8
Table Section Summary .....	9
Table Station Summary (Increasing) .....	10
Table Station Summary (Decreasing) .....	16

## List of Figures

Figure Graphical Results (Increasing) .....	3
Figure Graphical Results (Decreasing) .....	5

## **Report Overview**

**Report Generated:** Apr 10, 2018 8:47 AM

**Report Template:** System: Multi-Page [System] (tam2, Oct 9, 2017 1:45 PM)

**Evaluation Date:** Tue Apr 10 08:45:15 AKDT 2018

**IHSDM Version:** v13.0.0 (Sep 13, 2017)

**Traffic Analysis Module:** v1.6.0 (Mar 24, 2017)

**User Name:** RaeAnne Hebnes

**Organization Name:** Michael Baker International

**Phone:**

**E-Mail:**

**Project Title:** P1

**Project Comment:** Created using wizard

**Project Unit System:** U.S. Customary

**Highway Title:** Alignment P1\_6apr2018

**Highway Comment:** Copied from Alignment P1\_29dec2017 (v3); revised passing lanes

**Highway Version:** 1

**Evaluation Title:** Evaluation 6

**Evaluation Comment:** Created Tue Apr 10 08:40:55 AKDT 2018

**Minimum Station:** 1327+09.000

**Maximum Station:** 2468+96.256

**Configuration Name:** Default

## **Traffic Analysis Graphical Results**

[[Graphical Results in the Engineer's Manual](#)]

Figure 1 below displays the graphical results of the Traffic Analysis Module evaluation for the increasing direction of travel.

Traffic Analysis Summary, Increasing Direction of Travel  
 Project: P1, Evaluation: Evaluation 6  
 Highway: Alignment P1\_6apr2018

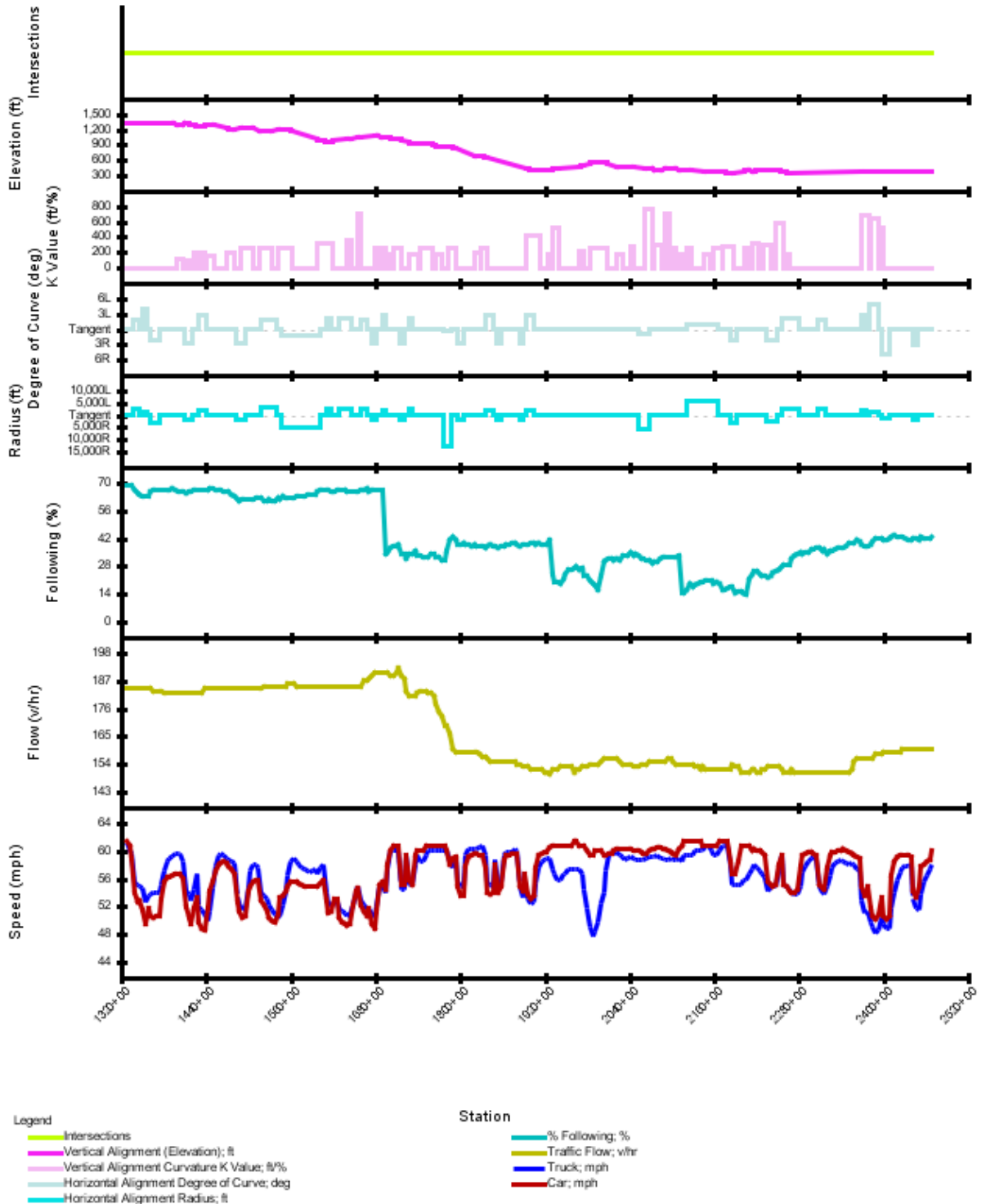

Figure 1. Graphical Results (Increasing)

Figure 2 below displays the graphical results of the Traffic Analysis Module evaluation for the decreasing direction of travel.



Traffic Analysis Summary, Decreasing Direction of Travel  
 Project: P1, Evaluation: Evaluation 6  
 Highway: Alignment P1\_6apr2018

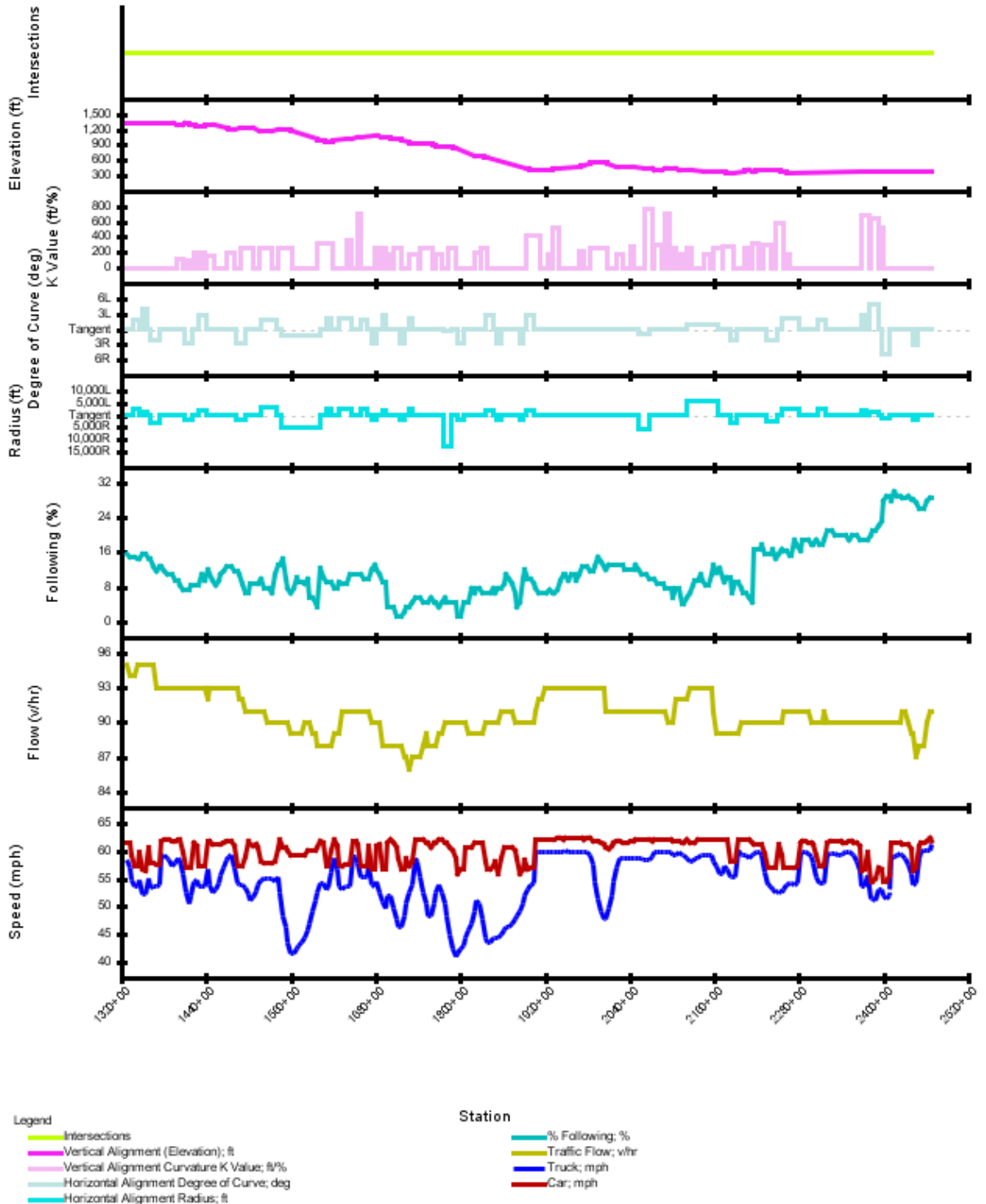

Figure 2. Graphical Results (Decreasing)



## Simulation Input Data

[Traffic Input Data in the Engineer's Manual]

**Table 1. Simulation Parameters**

Simulation Time (min)	60
Warm-up Time (min)	10
Total Time (min)	70
Computer Time (sec)	1
Test Road Length (mi)	21.6264

**Table 2. Random Number Generator Seeds**

Description	Value
Entering Traffic in Platoons / Direction of Increasing Stations	81250132
Desired Speed / Direction of Increasing Stations	70867724
Entering Traffic in Platoons / Direction of Decreasing Stations	33333334
Desired Speed / Direction of Decreasing Stations	16532240
Passing Decisions	52338126

**Table 3. Traffic Input Data**

Direction of Travel	Flow Rate (vph)	Distribution Cars (%)	Distribution Trucks (%)	Distribution RVs (%)	Mean Desired Speed Cars (mph)	Mean Desired Speed Trucks (mph)	Mean Desired Speed RVs (mph)	Desired Speed Standard Deviation Cars (mph)	Desired Speed Standard Deviation Trucks (mph)	Desired Speed Standard Deviation RVs (mph)	Entering Traffic in Platoons (%)	No Passing Zone (%)
Increasing	170	83	17	0	61.5	59.5	59.5	5.0	3.5	4.0	65	0
Decreasing	91	83	17	0	61.5	59.5	59.5	5.0	3.5	4.0	35	0

## Simulation Output Summary

[Section Summary in the Engineer's Manual]

Table 4 below includes the traffic output data table for the main road section. The table reports the actual simulated flow rate, percent time spent following, average speed, trip time, traffic delay, geometric delay, total delay, number of passes, vehicle-distance traveled, and vehicle-hours of travel. These simulation outputs are reported for each direction and both directions combined.

**Table 4. Section Summary**

Direction of Travel	Flow Rate from Simulation (vph)	Percent Time Spent Following (%)	Average Travel Speed (mph)	Trip Time (min/veh)	Traffic Delay (min/veh)	Geometric Delay (min/veh)	Total Delay (min/v eh)	Number of Passes	Distance Traveled (mi)	Total Travel Time (veh-hrs)
Increasing	168	46	56.0	22.9	0.8	0.8	1.5	431	3,594.4	64.2
Decreasing	91	12	58.6	22.0	-0.4	1.1	0.7	175	1,962.2	33.5
Combined	259	34	56.9	22.6	0.3	0.9	1.2	606	5,556.6	97.7

## Simulation Station Summaries

[Station Summary in the Engineer's Manual]

Table 5 below reports spot traffic operational data collected by the simulation at each data collection station for travel in direction of increasing stations. These data are analogous to data that would be collected by a traffic data recorder placed at the specified location on the highway during the simulation time. The data include hourly traffic volume; measured mean speed of cars, trucks, and recreational vehicles; mean and standard deviation speed for all vehicles combined; percent of vehicles following at a headway of less than 4 seconds; the average platoon size; and number of passes. A separate table is produced for each direction of travel. The data in this station summary data tables are used to create graphs.

**Table 5. Station Summary (Increasing)**

Station Number	Station	Number of Lanes	Traffic Volume (vpd)	Speed Mean Cars (mph)	Speed Mean Trucks (mph)	Speed Mean RVs (mph)	Speed Mean All (mph)	Percent Following (%)	Platoon Size	Number of Passes
1	1327+25.404	1	184	61.4	61.1	0.0	61.4	68	5.2	0.0
2	1331+07.191	1	184	60.8	60.0	0.0	60.7	68	5.2	0.0
3	1334+88.979	1	184	58.9	59.6	0.0	59.0	68	5.2	0.0
4	1338+70.766	1	184	53.9	55.3	0.0	54.1	67	4.6	0.0
5	1342+52.554	1	184	52.6	55.2	0.0	52.9	65	4.4	0.0
6	1346+34.341	1	184	52.9	55.0	0.0	53.2	64	4.4	0.0
7	1350+16.129	1	184	51.5	54.6	0.0	51.9	64	4.3	0.0
8	1353+97.916	1	184	49.4	52.6	0.0	49.8	64	4.3	0.0
9	1357+79.704	1	184	51.8	53.5	0.0	52.0	64	4.3	0.0
10	1361+61.491	1	184	50.7	53.8	0.0	51.1	66	4.7	0.0
11	1365+43.279	1	183	50.3	53.9	0.0	50.7	66	4.7	0.0
12	1369+25.066	1	183	50.6	54.1	0.0	51.0	66	4.7	0.0
13	1373+06.853	1	183	50.7	54.1	0.0	51.1	66	4.7	0.0
14	1376+88.641	1	183	53.2	55.1	0.0	53.5	66	4.7	0.0
15	1380+70.428	1	182	55.5	57.1	0.0	55.7	66	4.7	0.0
16	1384+52.216	1	182	56.2	58.4	0.0	56.5	66	4.7	1.0
17	1388+34.003	1	182	56.3	58.9	0.0	56.6	66	4.7	0.0
18	1392+15.791	1	182	56.4	59.1	0.0	56.7	67	4.8	0.0
19	1395+97.578	1	182	56.7	59.6	0.0	57.0	66	4.8	0.0
20	1399+79.366	1	182	56.7	59.7	0.0	57.1	66	4.6	0.0
21	1403+61.153	1	182	56.6	59.7	0.0	56.9	66	4.6	0.0
22	1407+42.940	1	182	56.0	58.4	0.0	56.3	66	4.6	0.0
23	1411+24.728	1	182	52.0	54.2	0.0	52.2	65	4.7	0.0
24	1415+06.515	1	182	50.4	53.7	0.0	50.8	66	4.9	0.0
25	1418+88.303	1	182	49.5	52.8	0.0	49.9	66	4.8	0.0
26	1422+70.090	1	182	51.8	54.5	0.0	52.1	66	4.8	0.0
27	1426+51.878	1	182	53.4	56.7	0.0	53.8	66	4.9	0.0
28	1430+33.665	1	182	49.8	52.0	0.0	50.1	66	4.9	0.0
29	1434+15.453	1	182	48.9	51.6	0.0	49.2	66	4.9	0.0
30	1437+97.240	1	184	48.5	50.9	0.0	48.8	66	4.8	0.0
31	1441+79.028	1	184	51.8	50.0	0.0	51.5	66	4.8	0.0
32	1445+60.815	1	184	54.3	51.4	0.0	53.9	67	4.8	0.0
33	1449+42.602	1	184	55.6	54.6	0.0	55.5	67	4.8	0.0
34	1453+24.390	1	184	57.2	57.8	0.0	57.3	67	4.6	0.0



Station Number	Station	Number of Lanes	Traffic Volume (vpd)	Speed Mean Cars (mph)	Speed Mean Trucks (mph)	Speed Mean RVs (mph)	Speed Mean All (mph)	Percent Following (%)	Platoon Size	Number of Passes
35	1457+06.177	1	184	58.0	59.3	0.0	58.2	67	4.6	3.0
36	1460+87.965	1	184	58.3	59.7	0.0	58.4	67	4.6	3.0
37	1464+69.752	1	184	58.5	59.4	0.0	58.6	66	4.7	5.0
38	1468+51.540	1	184	58.3	59.0	0.0	58.4	66	4.5	3.0
39	1472+33.327	1	184	57.8	58.8	0.0	57.9	66	4.6	2.0
40	1476+15.115	1	184	57.3	58.5	0.0	57.4	64	4.7	0.0
41	1479+96.902	1	184	56.7	58.2	0.0	56.9	63	4.6	0.0
42	1483+78.689	1	184	52.6	53.3	0.0	52.6	62	4.7	0.0
43	1487+60.477	1	184	51.3	52.4	0.0	51.4	61	4.5	0.0
44	1491+42.264	1	184	50.3	51.5	0.0	50.4	61	4.7	0.0
45	1495+24.052	1	184	50.7	51.8	0.0	50.8	62	4.7	0.0
46	1499+05.839	1	184	54.3	54.6	0.0	54.3	62	4.7	0.0
47	1502+87.627	1	184	55.0	57.1	0.0	55.3	62	4.8	0.0
48	1506+69.414	1	184	55.5	58.0	0.0	55.8	62	4.8	0.0
49	1510+51.202	1	184	55.8	58.0	0.0	56.1	62	5.0	0.0
50	1514+32.989	1	184	55.7	57.7	0.0	56.0	62	5.0	0.0
51	1518+14.777	1	184	52.9	54.0	0.0	53.0	62	5.0	0.0
52	1521+96.564	1	185	52.1	53.6	0.0	52.3	61	4.8	0.0
53	1525+78.351	1	185	51.3	53.0	0.0	51.5	61	4.8	0.0
54	1529+60.139	1	185	50.5	52.3	0.0	50.7	62	4.8	0.0
55	1533+41.926	1	185	49.9	51.5	0.0	50.1	61	4.8	0.0
56	1537+23.714	1	185	49.7	50.9	0.0	49.8	61	4.8	0.0
57	1541+05.501	1	185	50.9	50.4	0.0	50.9	62	4.8	0.0
58	1544+87.289	1	185	53.4	50.7	0.0	53.0	62	4.7	0.0
59	1548+69.076	1	185	53.5	52.2	0.0	53.3	63	5.2	0.0
60	1552+50.864	1	185	54.3	54.3	0.0	54.3	63	5.0	0.0
61	1556+32.651	1	186	55.0	56.5	0.0	55.2	62	5.0	0.0
62	1560+14.438	1	186	55.5	58.4	0.0	55.8	62	5.0	0.0
63	1563+96.226	1	186	55.6	59.0	0.0	56.0	62	5.0	0.0
64	1567+78.013	1	185	55.6	58.6	0.0	56.0	63	5.0	0.0
65	1571+59.801	1	185	55.4	58.0	0.0	55.7	63	4.9	0.0
66	1575+41.588	1	185	55.2	57.6	0.0	55.5	63	4.9	0.0
67	1579+23.376	1	185	55.0	57.3	0.0	55.3	63	4.9	0.0
68	1583+05.163	1	185	54.9	57.1	0.0	55.2	64	4.8	0.0
69	1586+86.951	1	185	54.9	56.9	0.0	55.2	64	5.0	0.0
70	1590+68.738	1	185	54.8	57.1	0.0	55.1	64	5.0	0.0
71	1594+50.526	1	185	54.8	57.3	0.0	55.1	64	5.0	0.0
72	1598+32.313	1	185	54.8	56.8	0.0	55.1	66	5.1	0.0
73	1602+14.100	1	185	55.4	57.5	0.0	55.7	66	5.0	0.0
74	1605+95.888	1	185	55.8	58.0	0.0	56.1	66	5.0	1.0
75	1609+77.675	1	185	52.9	54.1	0.0	53.0	66	5.0	0.0
76	1613+59.463	1	185	51.1	52.4	0.0	51.3	66	5.0	0.0
77	1617+41.250	1	185	51.2	52.2	0.0	51.3	66	4.9	0.0
78	1621+23.038	1	185	53.1	52.6	0.0	53.0	66	4.9	0.0
79	1625+04.825	1	185	53.0	52.7	0.0	53.0	66	5.0	1.0
80	1628+86.613	1	185	50.5	51.7	0.0	50.7	66	5.0	0.0
81	1632+68.400	1	185	49.8	51.4	0.0	50.0	66	5.0	0.0
82	1636+50.187	1	185	49.5	51.0	0.0	49.7	66	5.1	0.0
83	1640+31.975	1	185	49.3	50.7	0.0	49.4	66	4.9	0.0
84	1644+13.762	1	185	49.4	50.8	0.0	49.6	66	4.9	0.0

Station Number	Station	Number of Lanes	Traffic Volume (vpd)	Speed Mean Cars (mph)	Speed Mean Trucks (mph)	Speed Mean RVs (mph)	Speed Mean All (mph)	Percent Following (%)	Platoon Size	Number of Passes
85	1647+95.550	1	185	52.2	52.1	0.0	52.2	66	4.9	0.0
86	1651+77.337	1	185	54.2	53.9	0.0	54.1	66	4.9	1.0
87	1655+59.125	1	185	54.7	55.0	0.0	54.7	66	5.1	0.0
88	1659+40.912	1	185	52.2	52.9	0.0	52.4	66	5.0	0.0
89	1663+22.700	1	187	51.4	52.3	0.0	51.5	66	4.9	0.0
90	1667+04.487	1	187	50.7	51.7	0.0	50.9	67	5.1	0.0
91	1670+86.275	1	188	51.8	51.8	0.0	51.8	66	4.9	0.0
92	1674+68.062	1	189	49.6	50.9	0.0	49.8	67	4.7	0.0
93	1678+49.849	1	190	48.9	50.7	0.0	49.2	66	4.7	0.0
94	1682+31.637	1	190	51.3	51.9	0.0	51.4	66	4.7	0.0
95	1686+13.424	1	190	55.1	54.9	0.0	55.0	66	4.7	0.0
96	1689+95.212	1	190	55.5	54.8	0.0	55.4	66	4.7	0.0
97	1693+76.999	2	190	54.5	53.9	0.0	54.5	34	2.9	2.0
98	1697+58.787	2	190	58.0	57.3	0.0	58.0	35	2.6	15.0
99	1701+40.574	2	189	60.0	60.0	0.0	60.0	38	2.6	14.0
100	1705+22.362	2	189	60.7	60.0	0.0	60.0	38	2.6	10.0
101	1709+04.149	2	190	60.7	60.0	0.0	60.7	38	2.6	3.0
102	1712+85.936	2	192	60.7	60.0	0.0	60.0	39	2.7	7.0
103	1716+67.724	2	189	55.2	54.5	0.0	55.2	34	2.6	11.0
104	1720+49.511	2	188	55.2	54.5	0.0	55.2	35	2.8	12.0
105	1724+31.299	2	183	59.3	59.3	0.0	59.3	32	2.7	13.0
106	1728+13.086	2	181	55.9	55.2	0.0	55.9	34	2.6	5.0
107	1731+94.874	2	181	55.2	55.2	0.0	55.2	34	2.8	13.0
108	1735+76.661	2	181	59.3	58.0	0.0	59.3	35	2.7	8.0
109	1739+58.449	2	182	60.0	59.3	0.0	60.0	34	2.7	5.0
110	1743+40.236	2	183	60.0	58.6	0.0	60.0	33	2.9	5.0
111	1747+22.024	2	183	60.0	58.6	0.0	60.0	33	2.8	4.0
112	1751+03.811	2	183	60.7	59.3	0.0	60.0	33	2.8	10.0
113	1754+85.598	2	182	60.7	60.0	0.0	60.7	33	3.0	4.0
114	1758+67.386	2	182	60.7	60.0	0.0	60.7	34	3.2	6.0
115	1762+49.173	2	181	60.7	60.0	0.0	60.7	34	3.1	4.0
116	1766+30.961	2	178	60.7	60.0	0.0	60.7	33	3.1	3.0
117	1770+12.748	2	175	60.7	60.0	0.0	60.7	33	3.0	5.0
118	1773+94.536	2	173	60.7	60.0	0.0	60.0	31	2.6	4.0
119	1777+76.323	2	169	60.7	60.0	0.0	60.7	31	2.8	4.0
120	1781+58.111	2	169	60.0	60.0	0.0	60.0	36	2.9	3.0
121	1785+39.898	2	166	58.0	58.6	0.0	58.0	42	3.2	10.0
122	1789+21.685	1	160	58.9	57.5	0.0	58.7	42	3.3	13.0
123	1793+03.473	1	159	59.2	59.0	0.0	59.1	42	3.3	0.0
124	1796+85.260	1	159	54.8	55.5	0.0	54.9	39	3.2	0.0
125	1800+67.048	1	159	53.6	55.0	0.0	53.8	39	3.2	0.0
126	1804+48.835	1	159	53.6	55.0	0.0	53.8	40	3.1	0.0
127	1808+30.623	1	159	57.9	59.4	0.0	58.1	39	3.1	0.0
128	1812+12.410	1	159	59.2	60.4	0.0	59.3	39	3.1	0.0
129	1815+94.198	1	159	59.5	60.4	0.0	59.6	38	3.4	0.0
130	1819+75.985	1	159	59.7	60.3	0.0	59.8	39	3.5	2.0
131	1823+57.773	1	159	59.7	60.4	0.0	59.9	38	3.5	2.0
132	1827+39.560	1	158	59.5	60.6	0.0	59.7	38	3.4	2.0
133	1831+21.347	1	157	59.5	60.7	0.0	59.6	38	3.3	0.0
134	1835+03.135	1	157	57.5	59.5	0.0	57.8	38	3.2	0.0

Station Number	Station	Number of Lanes	Traffic Volume (vpd)	Speed Mean Cars (mph)	Speed Mean Trucks (mph)	Speed Mean RVs (mph)	Speed Mean All (mph)	Percent Following (%)	Platoon Size	Number of Passes
135	1838+84.922	1	156	54.1	55.4	0.0	54.3	38	3.1	0.0
136	1842+66.710	1	155	53.7	55.1	0.0	53.9	39	3.1	0.0
137	1846+48.497	1	155	53.9	55.0	0.0	54.1	38	3.0	0.0
138	1850+30.285	1	155	58.1	58.8	0.0	58.2	38	3.0	0.0
139	1854+12.072	1	155	53.9	54.8	0.0	54.0	37	3.0	0.0
140	1857+93.860	1	155	55.0	55.6	0.0	55.1	38	3.0	0.0
141	1861+75.647	1	155	58.7	59.5	0.0	58.8	38	3.0	1.0
142	1865+57.434	1	155	59.3	59.8	0.0	59.3	39	3.1	0.0
143	1869+39.222	1	155	59.5	59.9	0.0	59.5	39	3.1	3.0
144	1873+21.009	1	155	59.6	59.9	0.0	59.6	39	3.1	0.0
145	1877+02.797	1	155	59.7	60.2	0.0	59.7	39	3.1	2.0
146	1880+84.584	1	154	59.7	60.1	0.0	59.8	39	3.2	0.0
147	1884+66.372	1	154	55.0	54.8	0.0	55.0	38	3.3	0.0
148	1888+48.159	1	153	54.3	53.3	0.0	54.1	39	3.2	0.0
149	1892+29.947	1	153	56.8	55.6	0.0	56.7	39	3.2	0.0
150	1896+11.734	1	153	53.7	53.0	0.0	53.6	39	3.2	0.0
151	1899+93.522	1	152	53.2	52.4	0.0	53.0	40	3.3	0.0
152	1903+75.309	1	152	53.6	52.7	0.0	53.5	40	3.3	0.0
153	1907+57.096	1	152	57.5	55.4	0.0	57.3	39	3.2	1.0
154	1911+38.884	1	152	59.3	57.6	0.0	59.0	40	3.4	2.0
155	1915+20.671	1	152	59.7	58.5	0.0	59.5	39	3.7	0.0
156	1919+02.459	1	151	59.9	58.8	0.0	59.7	39	3.7	2.0
157	1922+84.246	1	151	59.9	58.9	0.0	59.8	39	3.8	2.0
158	1926+66.034	1	150	60.5	59.0	0.0	60.3	41	3.7	1.0
159	1930+47.821	2	152	60.7	57.3	0.0	60.0	24	2.6	0.0
160	1934+29.609	2	152	60.7	56.6	0.0	60.0	20	2.4	0.0
161	1938+11.396	2	152	60.7	55.9	0.0	60.0	20	2.5	6.0
162	1941+93.183	2	153	60.7	55.9	0.0	60.0	20	2.5	3.0
163	1945+74.971	2	153	60.7	56.6	0.0	60.0	22	2.6	3.0
164	1949+56.758	2	153	60.7	56.6	0.0	60.0	24	2.8	6.0
165	1953+38.546	2	153	60.7	57.3	0.0	60.0	26	2.8	4.0
166	1957+20.333	2	153	60.7	57.3	0.0	60.7	26	2.5	6.0
167	1961+02.121	2	151	61.4	57.3	0.0	60.7	27	2.5	3.0
168	1964+83.908	2	152	61.4	57.3	0.0	60.7	28	2.6	3.0
169	1968+65.696	2	152	60.7	57.3	0.0	60.7	26	2.4	1.0
170	1972+47.483	2	153	60.7	56.6	0.0	60.0	27	2.5	1.0
171	1976+29.271	2	153	60.7	54.5	0.0	59.3	24	2.5	2.0
172	1980+11.058	2	153	60.0	51.8	0.0	58.6	24	2.6	6.0
173	1983+92.845	2	154	59.3	49.1	0.0	58.0	21	2.6	3.0
174	1987+74.633	2	154	59.3	47.7	0.0	58.0	20	2.6	4.0
175	1991+56.420	2	154	60.0	48.4	0.0	58.0	18	2.6	4.0
176	1995+38.208	2	154	60.0	49.8	0.0	58.6	16	2.7	5.0
177	1999+19.995	2	155	60.0	52.5	0.0	58.6	23	2.6	6.0
178	2003+01.783	2	156	59.3	53.9	0.0	58.6	30	3.1	3.0
179	2006+83.570	1	156	59.5	57.1	0.0	59.2	31	3.5	0.0
180	2010+65.358	1	156	59.7	59.3	0.0	59.6	32	3.4	0.0
181	2014+47.145	1	156	59.7	59.9	0.0	59.8	32	3.4	0.0
182	2018+28.932	1	156	60.0	59.7	0.0	59.9	31	3.2	1.0
183	2022+10.720	1	156	60.2	59.9	0.0	60.2	32	3.2	0.0
184	2025+92.507	1	155	60.3	59.5	0.0	60.1	31	3.1	1.0

Station Number	Station	Number of Lanes	Traffic Volume (vpd)	Speed Mean Cars (mph)	Speed Mean Trucks (mph)	Speed Mean RVs (mph)	Speed Mean All (mph)	Percent Following (%)	Platoon Size	Number of Passes
185	2029+74.295	1	154	60.3	59.2	0.0	60.1	33	3.3	1.0
186	2033+56.082	1	154	60.3	58.8	0.0	60.1	34	3.3	1.0
187	2037+37.870	1	154	60.3	59.0	0.0	60.1	34	3.1	0.0
188	2041+19.657	1	154	60.3	59.1	0.0	60.1	35	3.3	0.0
189	2045+01.445	1	153	60.1	58.9	0.0	60.0	33	3.2	0.0
190	2048+83.232	1	153	60.1	58.8	0.0	59.9	34	3.2	0.0
191	2052+65.020	1	153	60.1	58.8	0.0	59.9	33	3.2	0.0
192	2056+46.807	1	154	59.9	58.8	0.0	59.7	32	3.1	0.0
193	2060+28.594	1	154	59.6	58.8	0.0	59.5	32	3.0	0.0
194	2064+10.382	1	154	59.6	59.0	0.0	59.5	31	2.9	0.0
195	2067+92.169	1	155	60.1	59.2	0.0	59.9	31	2.9	0.0
196	2071+73.957	1	155	60.3	59.1	0.0	60.1	30	2.9	0.0
197	2075+55.744	1	155	60.4	59.2	0.0	60.2	30	3.0	2.0
198	2079+37.532	1	155	60.5	59.3	0.0	60.3	30	3.0	3.0
199	2083+19.319	1	155	60.5	59.0	0.0	60.3	32	3.1	0.0
200	2087+01.107	1	155	60.4	59.0	0.0	60.2	32	3.2	2.0
201	2090+82.894	1	155	60.2	58.8	0.0	60.0	33	3.2	1.0
202	2094+64.681	1	156	60.1	58.8	0.0	59.9	33	3.2	0.0
203	2098+46.469	1	156	59.9	58.9	0.0	59.7	33	3.2	0.0
204	2102+28.256	1	155	59.7	58.8	0.0	59.5	32	3.3	0.0
205	2106+10.044	1	154	59.5	58.8	0.0	59.4	32	3.3	0.0
206	2109+91.831	1	154	60.4	59.0	0.0	60.2	33	3.2	0.0
207	2113+73.619	2	154	60.7	58.6	0.0	60.7	14	2.5	0.0
208	2117+55.406	2	154	61.4	59.3	0.0	60.7	14	2.2	2.0
209	2121+37.194	2	154	61.4	59.3	0.0	60.7	16	2.4	6.0
210	2125+18.981	2	154	61.4	59.3	0.0	60.7	20	2.5	4.0
211	2129+00.769	2	154	61.4	59.3	0.0	60.7	18	2.3	6.0
212	2132+82.556	2	153	61.4	60.0	0.0	60.7	18	2.3	2.0
213	2136+64.343	2	153	61.4	60.0	0.0	60.7	19	2.3	5.0
214	2140+46.131	2	152	61.4	60.0	0.0	60.7	20	2.3	1.0
215	2144+27.918	2	153	60.7	60.0	0.0	60.7	20	2.4	7.0
216	2148+09.706	2	152	60.7	60.7	0.0	60.7	21	2.5	2.0
217	2151+91.493	2	152	60.7	60.7	0.0	60.7	21	2.6	1.0
218	2155+73.281	2	152	60.7	60.0	0.0	60.7	21	2.7	2.0
219	2159+55.068	2	152	60.7	59.3	0.0	60.7	19	2.5	1.0
220	2163+36.856	2	152	60.7	59.3	0.0	60.7	20	2.5	4.0
221	2167+18.643	2	152	61.4	60.0	0.0	60.7	19	2.3	6.0
222	2171+00.430	2	152	61.4	60.7	0.0	61.4	16	2.2	1.0
223	2174+82.218	2	152	61.4	60.7	0.0	61.4	16	2.3	3.0
224	2178+64.005	2	152	61.4	60.7	0.0	60.7	17	2.3	3.0
225	2182+45.793	2	152	58.6	58.0	0.0	58.6	18	2.3	3.0
226	2186+27.580	2	154	56.6	55.2	0.0	55.9	18	2.5	3.0
227	2190+09.368	2	153	56.6	55.2	0.0	55.9	14	2.2	6.0
228	2193+91.155	2	153	58.6	55.2	0.0	58.0	16	2.2	2.0
229	2197+72.943	2	151	60.7	55.2	0.0	60.0	15	2.2	1.0
230	2201+54.730	2	151	60.7	55.9	0.0	60.0	15	2.2	3.0
231	2205+36.518	2	151	60.7	55.9	0.0	60.0	14	2.2	0.0
232	2209+18.305	2	151	60.7	56.6	0.0	60.0	22	2.6	7.0
233	2213+00.092	2	152	60.0	57.3	0.0	59.3	24	2.9	2.0
234	2216+81.880	1	152	60.3	58.0	0.0	59.9	26	3.0	1.0

Station Number	Station	Number of Lanes	Traffic Volume (vpd)	Speed Mean Cars (mph)	Speed Mean Trucks (mph)	Speed Mean RVs (mph)	Speed Mean All (mph)	Percent Following (%)	Platoon Size	Number of Passes
235	2220+63.667	1	151	60.1	57.7	0.0	59.7	26	3.0	0.0
236	2224+45.455	1	151	60.0	57.1	0.0	59.5	24	3.3	0.0
237	2228+27.242	1	152	59.9	56.6	0.0	59.3	23	3.2	0.0
238	2232+09.030	1	152	59.5	56.3	0.0	59.0	23	3.5	0.0
239	2235+90.817	1	153	55.6	54.3	0.0	55.4	22	3.4	0.0
240	2239+72.605	1	153	55.2	54.8	0.0	55.2	23	3.3	0.0
241	2243+54.392	1	153	55.0	54.8	0.0	55.0	25	3.1	0.0
242	2247+36.179	1	153	55.2	55.0	0.0	55.1	26	2.9	0.0
243	2251+17.967	1	153	58.0	57.1	0.0	57.8	26	2.9	0.0
244	2254+99.754	1	152	59.3	59.5	0.0	59.3	28	2.9	0.0
245	2258+81.542	1	151	55.2	55.2	0.0	55.2	29	3.1	0.0
246	2262+63.329	1	151	54.8	54.8	0.0	54.8	29	3.1	0.0
247	2266+45.117	1	151	54.3	54.5	0.0	54.3	29	3.1	0.0
248	2270+26.904	1	152	54.1	54.1	0.0	54.1	32	3.3	0.0
249	2274+08.692	1	151	54.0	53.8	0.0	53.9	33	3.5	0.0
250	2277+90.479	1	151	54.4	53.7	0.0	54.3	34	3.5	0.0
251	2281+72.267	1	151	57.8	55.0	0.0	57.3	35	3.5	0.0
252	2285+54.054	1	151	59.5	56.9	0.0	59.0	34	3.4	2.0
253	2289+35.841	1	151	59.7	57.9	0.0	59.5	35	3.4	4.0
254	2293+17.629	1	151	59.9	58.6	0.0	59.7	35	3.4	1.0
255	2296+99.416	1	151	59.9	59.0	0.0	59.7	36	3.4	1.0
256	2300+81.204	1	151	59.7	59.1	0.0	59.7	36	3.2	0.0
257	2304+62.991	1	151	59.3	58.8	0.0	59.2	37	3.1	0.0
258	2308+44.779	1	151	55.2	54.8	0.0	55.1	37	3.1	0.0
259	2312+26.566	1	151	54.7	54.1	0.0	54.6	36	3.1	0.0
260	2316+08.354	1	151	54.5	53.7	0.0	54.4	36	3.2	0.0
261	2319+90.141	1	151	57.7	54.8	0.0	57.2	34	2.9	0.0
262	2323+71.928	1	151	59.5	56.4	0.0	59.0	36	3.2	1.0
263	2327+53.716	1	151	59.8	57.5	0.0	59.5	36	3.2	5.0
264	2331+35.503	1	151	59.9	58.3	0.0	59.6	36	3.2	1.0
265	2335+17.291	1	151	60.0	58.6	0.0	59.7	37	3.1	1.0
266	2338+99.078	1	151	60.1	58.8	0.0	59.9	37	3.1	0.0
267	2342+80.866	1	151	60.2	58.6	0.0	59.9	38	3.2	3.0
268	2346+62.653	1	151	60.1	58.2	0.0	59.8	38	3.1	0.0
269	2350+44.441	1	151	59.9	58.1	0.0	59.7	40	3.1	1.0
270	2354+26.228	1	152	59.7	58.2	0.0	59.5	40	3.3	1.0
271	2358+08.016	1	155	59.5	58.0	0.0	59.2	40	3.2	0.0
272	2361+89.803	1	156	59.1	57.4	0.0	58.8	41	3.4	0.0
273	2365+71.590	1	156	58.9	57.2	0.0	58.6	40	3.3	0.0
274	2369+53.378	1	156	55.0	52.8	0.0	54.6	39	3.2	0.0
275	2373+35.165	1	156	53.5	51.1	0.0	53.0	38	3.1	0.0
276	2377+16.953	1	156	54.9	51.3	0.0	54.3	38	2.9	0.0
277	2380+98.740	1	156	51.8	49.7	0.0	51.5	39	3.0	0.0
278	2384+80.528	1	156	50.7	49.1	0.0	50.5	40	3.1	0.0
279	2388+62.315	1	158	50.2	48.1	0.0	49.8	42	3.1	0.0
280	2392+44.103	1	158	50.8	48.5	0.0	50.4	42	3.1	0.0
281	2396+25.890	1	158	53.4	50.5	0.0	52.9	42	3.1	0.0
282	2400+07.677	1	159	50.6	49.4	0.0	50.4	42	3.1	0.0
283	2403+89.465	1	159	50.1	48.8	0.0	49.9	41	3.1	0.0
284	2407+71.252	1	159	50.7	48.8	0.0	50.4	42	3.2	0.0

Station Number	Station	Number of Lanes	Traffic Volume (vpd)	Speed Mean Cars (mph)	Speed Mean Trucks (mph)	Speed Mean RVs (mph)	Speed Mean All (mph)	Percent Following (%)	Platoon Size	Number of Passes
285	2411+53.040	1	159	56.5	51.7	0.0	55.6	43	3.3	0.0
286	2415+34.827	1	159	58.6	54.1	0.0	57.9	43	3.2	1.0
287	2419+16.615	1	159	59.2	55.8	0.0	58.6	43	3.1	3.0
288	2422+98.402	1	159	59.3	56.9	0.0	58.9	43	3.1	2.0
289	2426+80.190	1	160	59.3	57.5	0.0	59.0	42	3.1	2.0
290	2430+61.977	1	160	59.3	57.9	0.0	59.0	42	3.1	3.0
291	2434+43.765	1	160	59.3	57.9	0.0	59.0	41	3.1	0.0
292	2438+25.552	1	160	59.2	58.0	0.0	59.0	41	3.1	0.0
293	2442+07.339	1	160	54.3	53.2	0.0	54.1	42	3.2	0.0
294	2445+89.127	1	160	53.3	51.7	0.0	53.0	42	3.3	0.0
295	2449+70.914	1	160	54.8	51.5	0.0	54.3	41	3.4	1.0
296	2453+52.702	1	160	57.8	53.7	0.0	57.1	42	3.3	0.0
297	2457+34.489	1	160	58.1	55.5	0.0	57.7	42	3.3	0.0
298	2461+16.277	1	160	58.4	56.5	0.0	58.1	42	3.3	0.0
299	2464+98.064	1	160	58.8	57.3	0.0	58.6	42	3.3	0.0
300	2468+79.852	1	160	60.0	58.0	0.0	59.7	42	3.3	0.0

Table 6 below reports spot traffic operational data collected by the simulation at each data collection station for travel in direction of decreasing stations. These data are analogous to data that would be collected by a traffic data recorder placed at the specified location on the highway during the simulation time. The data include hourly traffic volume; measured mean speed of cars, trucks, and recreational vehicles; mean and standard deviation speed for all vehicles combined; percent of vehicles following at a headway of less than 4 seconds; the average platoon size; and number of passes. A separate table is produced for each direction of travel. The data in this station summary data tables are used to create graphs.

**Table 6. Station Summary (Decreasing)**

Station Number	Station	Number of Lanes	Traffic Volume (vpd)	Speed Mean Cars (mph)	Speed Mean Trucks (mph)	Speed Mean RVs (mph)	Speed Mean All (mph)	Percent Following (%)	Platoon Size	Number of Passes
1	2468+79.852	1	91	61.9	61.1	0.0	61.8	29	2.9	0.0
2	2464+98.064	1	91	62.3	60.1	0.0	61.9	29	2.9	0.0
3	2461+16.277	1	90	61.7	60.2	0.0	61.5	28	2.8	0.0
4	2457+34.489	1	88	61.4	60.1	0.0	61.2	26	2.6	0.0
5	2453+52.702	1	88	61.5	59.7	0.0	61.2	26	2.6	0.0
6	2449+70.914	1	88	61.0	58.6	0.0	60.6	26	2.6	2.0
7	2445+89.127	1	87	56.9	54.3	0.0	56.5	28	2.6	2.0
8	2442+07.339	1	89	56.5	53.8	0.0	56.0	28	2.6	2.0
9	2438+25.552	1	89	60.3	55.8	0.0	59.5	28	2.7	1.0
10	2434+43.765	1	90	61.3	57.6	0.0	60.8	29	2.9	0.0
11	2430+61.977	1	91	61.3	58.6	0.0	61.0	29	2.6	0.0
12	2426+80.190	1	91	61.3	59.2	0.0	61.0	29	2.4	1.0
13	2422+98.402	1	90	61.4	59.4	0.0	61.1	29	2.4	1.0
14	2419+16.615	1	90	61.4	59.3	0.0	61.1	29	2.4	2.0
15	2415+34.827	1	90	61.6	59.0	0.0	61.2	30	2.5	1.0
16	2411+53.040	1	90	61.6	58.8	0.0	61.2	28	2.4	0.0



Station Number	Station	Number of Lanes	Traffic Volume (vpd)	Speed Mean Cars (mph)	Speed Mean Trucks (mph)	Speed Mean RVs (mph)	Speed Mean All (mph)	Percent Following (%)	Platoon Size	Number of Passes
17	2407+71.252	1	90	55.6	52.0	0.0	55.0	29	2.4	2.0
18	2403+89.465	1	90	54.6	51.5	0.0	54.2	29	2.5	1.0
19	2400+07.677	1	90	54.5	51.8	0.0	54.2	28	2.5	2.0
20	2396+25.890	1	90	56.7	53.1	0.0	56.2	23	2.3	2.0
21	2392+44.103	1	90	56.9	53.0	0.0	56.3	22	2.3	1.0
22	2388+62.315	1	90	54.9	51.1	0.0	54.3	21	2.4	3.0
23	2384+80.528	1	90	54.5	51.3	0.0	54.0	21	2.4	0.0
24	2380+98.740	1	90	54.5	51.3	0.0	54.1	20	2.3	0.0
25	2377+16.953	1	90	59.7	55.6	0.0	59.1	19	2.5	0.0
26	2373+35.165	1	90	56.6	53.6	0.0	56.2	19	2.5	0.0
27	2369+53.378	1	90	56.5	53.5	0.0	56.1	19	2.5	0.0
28	2365+71.590	1	90	61.0	56.3	0.0	60.3	19	2.5	1.0
29	2361+89.803	1	90	61.4	58.2	0.0	61.0	20	2.5	0.0
30	2358+08.016	1	90	61.6	59.2	0.0	61.2	20	2.5	1.0
31	2354+26.228	1	90	61.8	59.5	0.0	61.4	20	2.5	0.0
32	2350+44.441	1	90	61.8	59.7	0.0	61.5	19	2.5	2.0
33	2346+62.653	1	90	61.6	59.7	0.0	61.3	20	2.5	0.0
34	2342+80.866	1	90	61.6	59.5	0.0	61.3	20	2.5	0.0
35	2338+99.078	1	90	61.8	59.3	0.0	61.4	20	2.5	0.0
36	2335+17.291	1	90	61.8	59.3	0.0	61.5	20	2.5	2.0
37	2331+35.503	1	90	61.9	59.5	0.0	61.5	20	2.5	1.0
38	2327+53.716	1	90	61.8	59.5	0.0	61.5	21	2.5	0.0
39	2323+71.928	1	90	61.8	59.4	0.0	61.4	21	2.5	1.0
40	2319+90.141	1	90	61.6	59.3	0.0	61.3	21	2.5	0.0
41	2316+08.354	1	91	57.5	54.3	0.0	57.1	19	2.4	0.0
42	2312+26.566	1	90	57.2	54.1	0.0	56.7	18	2.5	0.0
43	2308+44.779	1	90	57.2	54.2	0.0	56.8	18	2.5	1.0
44	2304+62.991	1	90	59.2	55.4	0.0	58.6	19	2.5	0.0
45	2300+81.204	1	90	61.3	57.8	0.0	60.8	18	2.5	0.0
46	2296+99.416	1	90	61.4	59.0	0.0	61.0	18	2.5	0.0
47	2293+17.629	1	91	61.6	59.5	0.0	61.3	19	2.5	0.0
48	2289+35.841	1	91	61.8	59.7	0.0	61.5	19	2.5	1.0
49	2285+54.054	1	91	61.8	59.7	0.0	61.6	19	2.5	2.0
50	2281+72.267	1	91	61.6	59.5	0.0	61.4	16	2.7	0.0
51	2277+90.479	1	91	57.2	54.2	0.0	56.9	18	2.8	0.0
52	2274+08.692	1	91	56.9	54.0	0.0	56.5	19	2.7	1.0
53	2270+26.904	1	91	56.9	54.2	0.0	56.6	15	2.6	1.0
54	2266+45.117	1	91	57.1	54.2	0.0	56.7	15	2.6	0.0
55	2262+63.329	1	91	56.9	54.0	0.0	56.5	16	2.5	0.0
56	2258+81.542	1	91	56.9	53.1	0.0	56.3	16	2.5	2.0
57	2254+99.754	1	90	59.3	52.5	0.0	58.4	17	2.5	0.0
58	2251+17.967	1	90	61.1	52.8	0.0	60.0	16	2.6	0.0
59	2247+36.179	1	90	57.1	52.6	0.0	56.5	14	2.6	0.0
60	2243+54.392	1	90	57.0	53.1	0.0	56.5	17	2.5	1.0
61	2239+72.605	1	90	56.9	53.5	0.0	56.5	16	2.4	0.0
62	2235+90.817	1	90	56.9	54.0	0.0	56.5	16	2.4	0.0
63	2232+09.030	1	90	59.5	56.1	0.0	59.0	16	2.4	0.0
64	2228+27.242	1	90	61.3	59.2	0.0	61.0	18	2.5	0.0
65	2224+45.455	1	90	61.3	59.8	0.0	61.1	17	2.4	0.0
66	2220+63.667	1	90	61.3	59.8	0.0	61.1	17	2.4	0.0

Station Number	Station	Number of Lanes	Traffic Volume (vpd)	Speed Mean Cars (mph)	Speed Mean Trucks (mph)	Speed Mean RVs (mph)	Speed Mean All (mph)	Percent Following (%)	Platoon Size	Number of Passes
67	2216+81.880	1	90	61.3	59.5	0.0	61.1	17	2.4	0.0
68	2213+00.092	2	90	61.4	59.3	0.0	61.4	4	2.0	0.0
69	2209+18.305	2	90	62.0	58.6	0.0	61.4	6	2.0	0.0
70	2205+36.518	2	90	62.0	59.3	0.0	61.4	7	2.0	2.0
71	2201+54.730	2	90	62.0	59.3	0.0	61.4	7	2.0	3.0
72	2197+72.943	2	90	62.0	59.3	0.0	61.4	8	2.0	3.0
73	2193+91.155	2	89	62.0	60.0	0.0	61.4	9	2.0	1.0
74	2190+09.368	2	89	58.0	55.2	0.0	57.3	9	2.0	4.0
75	2186+27.580	2	89	58.0	55.2	0.0	57.3	7	2.0	0.0
76	2182+45.793	2	89	58.0	55.2	0.0	58.0	10	2.3	2.0
77	2178+64.005	2	89	62.0	56.6	0.0	61.4	10	2.0	0.0
78	2174+82.218	2	89	62.0	57.3	0.0	61.4	9	2.0	2.0
79	2171+00.430	2	89	62.0	55.9	0.0	60.7	10	2.0	2.0
80	2167+18.643	2	89	62.0	55.9	0.0	60.7	12	2.1	1.0
81	2163+36.856	2	89	62.0	57.3	0.0	61.4	11	2.0	3.0
82	2159+55.068	2	91	62.0	58.0	0.0	61.4	13	2.0	0.0
83	2155+73.281	2	93	62.0	59.3	0.0	61.4	11	2.0	1.0
84	2151+91.493	2	93	62.0	59.3	0.0	61.4	9	2.0	1.0
85	2148+09.706	2	93	62.0	59.3	0.0	61.4	9	2.0	0.0
86	2144+27.918	2	93	62.0	59.3	0.0	61.4	10	2.1	1.0
87	2140+46.131	2	93	62.0	59.3	0.0	61.4	11	2.0	0.0
88	2136+64.343	2	93	62.0	58.6	0.0	61.4	10	2.0	0.0
89	2132+82.556	2	93	61.4	58.6	0.0	61.4	10	2.0	0.0
90	2129+00.769	2	93	61.4	58.0	0.0	61.4	9	2.0	0.0
91	2125+18.981	2	93	61.4	58.0	0.0	61.4	6	2.0	0.0
92	2121+37.194	2	92	62.0	58.6	0.0	61.4	5	2.0	0.0
93	2117+55.406	2	92	61.4	59.3	0.0	61.4	4	2.0	0.0
94	2113+73.619	2	92	61.4	59.3	0.0	61.4	4	2.0	0.0
95	2109+91.831	1	92	61.7	59.7	0.0	61.4	8	2.0	1.0
96	2106+10.044	1	92	61.8	59.3	0.0	61.4	8	2.0	0.0
97	2102+28.256	1	90	61.8	59.3	0.0	61.5	6	2.0	0.0
98	2098+46.469	1	90	62.0	59.7	0.0	61.6	8	2.0	0.0
99	2094+64.681	1	90	62.0	59.9	0.0	61.7	8	2.0	0.0
100	2090+82.894	1	91	62.0	59.9	0.0	61.8	8	2.0	0.0
101	2087+01.107	1	91	62.0	59.9	0.0	61.7	9	2.0	0.0
102	2083+19.319	1	91	62.0	59.9	0.0	61.8	9	2.0	1.0
103	2079+37.532	1	91	62.0	59.9	0.0	61.8	9	2.0	1.0
104	2075+55.744	1	91	62.0	59.8	0.0	61.6	10	2.0	0.0
105	2071+73.957	1	91	61.8	59.0	0.0	61.5	10	2.0	0.0
106	2067+92.169	1	91	62.0	58.4	0.0	61.4	10	2.0	0.0
107	2064+10.382	1	91	62.0	58.3	0.0	61.5	11	2.0	1.0
108	2060+28.594	1	91	62.1	58.4	0.0	61.6	11	2.0	0.0
109	2056+46.807	1	91	62.1	58.6	0.0	61.6	11	2.0	0.0
110	2052+65.020	1	91	62.0	58.7	0.0	61.6	12	2.1	1.0
111	2048+83.232	1	91	62.0	58.7	0.0	61.5	13	2.1	0.0
112	2045+01.445	1	91	61.8	58.6	0.0	61.4	12	2.1	0.0
113	2041+19.657	1	91	61.8	58.8	0.0	61.4	12	2.1	0.0
114	2037+37.870	1	91	61.6	58.8	0.0	61.2	12	2.1	0.0
115	2033+56.082	1	91	61.6	58.7	0.0	61.2	12	2.1	0.0
116	2029+74.295	1	91	61.6	58.8	0.0	61.2	13	2.1	0.0

Station Number	Station	Number of Lanes	Traffic Volume (vpd)	Speed Mean Cars (mph)	Speed Mean Trucks (mph)	Speed Mean RVs (mph)	Speed Mean All (mph)	Percent Following (%)	Platoon Size	Number of Passes
117	2025+92.507	1	91	61.7	58.6	0.0	61.3	13	2.1	0.0
118	2022+10.720	1	91	61.7	57.1	0.0	61.1	13	2.1	1.0
119	2018+28.932	1	91	61.4	54.4	0.0	60.4	13	2.1	1.0
120	2014+47.145	1	91	61.0	51.8	0.0	59.7	13	2.1	1.0
121	2010+65.358	1	91	60.5	49.6	0.0	59.0	13	2.1	1.0
122	2006+83.570	1	91	60.6	47.7	0.0	58.8	12	2.1	0.0
123	2003+01.783	1	93	61.3	47.7	0.0	59.4	13	2.1	0.0
124	1999+19.995	1	93	61.6	49.1	0.0	59.8	14	2.1	0.0
125	1995+38.208	1	93	61.8	51.5	0.0	60.3	15	2.1	0.0
126	1991+56.420	1	93	61.8	54.5	0.0	60.8	13	2.0	1.0
127	1987+74.633	1	93	61.9	57.5	0.0	61.3	12	2.0	1.0
128	1983+92.845	1	93	62.2	59.3	0.0	61.8	12	2.0	1.0
129	1980+11.058	1	93	62.3	59.8	0.0	61.9	13	2.1	2.0
130	1976+29.271	1	93	62.1	59.9	0.0	61.8	13	2.1	1.0
131	1972+47.483	1	93	62.2	59.9	0.0	61.8	13	2.1	0.0
132	1968+65.696	1	93	62.3	59.9	0.0	61.9	11	2.0	1.0
133	1964+83.908	1	93	62.3	59.9	0.0	62.0	10	2.0	0.0
134	1961+02.121	1	93	62.3	59.9	0.0	61.9	11	2.0	1.0
135	1957+20.333	1	93	62.3	59.7	0.0	61.9	11	2.0	0.0
136	1953+38.546	1	93	62.3	59.8	0.0	61.9	10	2.0	0.0
137	1949+56.758	1	93	62.2	60.0	0.0	61.8	11	2.0	2.0
138	1945+74.971	1	93	62.1	59.9	0.0	61.8	11	2.0	0.0
139	1941+93.183	1	93	62.2	59.9	0.0	61.9	10	2.0	0.0
140	1938+11.396	1	93	62.2	59.9	0.0	61.8	8	2.0	1.0
141	1934+29.609	1	93	62.1	59.9	0.0	61.8	6	2.0	0.0
142	1930+47.821	1	93	62.1	59.9	0.0	61.8	6	2.0	0.0
143	1926+66.034	1	93	62.1	59.9	0.0	61.8	8	2.0	0.0
144	1922+84.246	1	93	62.1	59.9	0.0	61.8	6	2.0	0.0
145	1919+02.459	1	93	62.0	59.9	0.0	61.7	6	2.0	0.0
146	1915+20.671	1	92	62.0	59.9	0.0	61.6	6	2.0	0.0
147	1911+38.884	1	92	62.0	59.9	0.0	61.7	6	2.0	0.0
148	1907+57.096	1	91	62.0	59.9	0.0	61.7	8	2.0	1.0
149	1903+75.309	1	90	57.1	54.2	0.0	56.7	9	2.0	1.0
150	1899+93.522	1	90	57.0	53.9	0.0	56.6	10	2.0	1.0
151	1896+11.734	1	90	56.7	53.2	0.0	56.1	10	2.1	0.0
152	1892+29.947	1	90	58.4	51.9	0.0	57.4	12	2.6	0.0
153	1888+48.159	1	90	56.6	50.5	0.0	55.7	10	2.5	0.0
154	1884+66.372	2	90	55.9	49.1	0.0	55.2	4	2.3	0.0
155	1880+84.584	2	90	58.6	48.4	0.0	57.3	3	2.5	1.0
156	1877+02.797	2	90	60.0	47.7	0.0	58.6	7	2.2	1.0
157	1873+21.009	2	91	60.7	47.0	0.0	58.6	9	2.1	2.0
158	1869+39.222	2	91	60.7	46.4	0.0	58.6	10	2.0	0.0
159	1865+57.434	2	91	60.7	46.4	0.0	58.6	11	2.0	1.0
160	1861+75.647	2	91	60.7	45.7	0.0	58.6	9	2.0	0.0
161	1857+93.860	2	91	58.6	45.0	0.0	56.6	8	2.0	1.0
162	1854+12.072	2	90	55.9	44.3	0.0	54.5	8	2.0	2.0
163	1850+30.285	2	90	58.0	44.3	0.0	55.9	7	2.2	1.0
164	1846+48.497	2	90	57.3	44.3	0.0	55.2	8	2.2	3.0
165	1842+66.710	2	90	56.6	43.6	0.0	54.5	7	2.2	2.0
166	1838+84.922	2	90	56.6	43.6	0.0	54.5	7	2.0	1.0

Station Number	Station	Number of Lanes	Traffic Volume (vpd)	Speed Mean Cars (mph)	Speed Mean Trucks (mph)	Speed Mean RVs (mph)	Speed Mean All (mph)	Percent Following (%)	Platoon Size	Number of Passes
167	1835+03.135	2	90	58.0	44.3	0.0	55.9	7	2.0	3.0
168	1831+21.347	2	89	61.4	47.7	0.0	59.3	7	2.2	0.0
169	1827+39.560	2	89	61.4	50.5	0.0	60.0	8	2.2	2.0
170	1823+57.773	2	89	61.4	51.1	0.0	60.0	8	2.2	0.0
171	1819+75.985	2	89	61.4	49.1	0.0	59.3	7	2.2	0.0
172	1815+94.198	2	89	60.7	47.0	0.0	59.3	8	2.4	0.0
173	1812+12.410	2	89	60.7	45.7	0.0	58.6	4	2.0	0.0
174	1808+30.623	2	90	60.7	44.3	0.0	58.0	4	2.0	0.0
175	1804+48.835	2	90	56.6	43.0	0.0	54.5	4	2.0	1.0
176	1800+67.048	2	90	56.6	42.3	0.0	54.5	1	2.0	1.0
177	1796+85.260	2	90	55.9	41.6	0.0	54.5	1	2.0	2.0
178	1793+03.473	2	90	58.6	40.9	0.0	56.6	4	2.0	2.0
179	1789+21.685	2	90	60.0	42.3	0.0	58.0	4	2.0	2.0
180	1785+39.898	2	90	60.7	45.0	0.0	58.6	4	2.0	0.0
181	1781+58.111	2	90	61.4	48.4	0.0	59.3	4	2.0	0.0
182	1777+76.323	2	90	61.4	50.5	0.0	60.0	6	2.0	0.0
183	1773+94.536	2	89	62.0	52.5	0.0	60.7	4	2.0	0.0
184	1770+12.748	2	89	62.0	53.9	0.0	60.7	3	2.0	0.0
185	1766+30.961	2	88	61.4	52.5	0.0	60.7	4	2.0	2.0
186	1762+49.173	2	88	61.4	50.5	0.0	60.0	4	2.0	0.0
187	1758+67.386	2	88	60.7	48.4	0.0	59.3	6	2.0	1.0
188	1754+85.598	2	88	61.4	48.4	0.0	59.3	4	2.0	0.0
189	1751+03.811	2	89	61.4	50.5	0.0	60.0	4	2.0	1.0
190	1747+22.024	2	88	62.0	52.5	0.0	60.7	4	2.0	1.0
191	1743+40.236	2	87	62.0	55.2	0.0	61.4	6	2.0	0.0
192	1739+58.449	2	87	62.0	58.0	0.0	61.4	6	2.0	0.0
193	1735+76.661	2	87	62.0	58.6	0.0	61.4	6	2.0	0.0
194	1731+94.874	2	87	58.0	53.9	0.0	57.3	5	2.0	0.0
195	1728+13.086	2	86	57.3	52.5	0.0	56.6	4	2.0	0.0
196	1724+31.299	2	87	58.6	50.5	0.0	58.0	3	2.0	0.0
197	1720+49.511	2	87	56.6	48.4	0.0	55.9	2	2.0	0.0
198	1716+67.724	2	88	56.6	46.4	0.0	55.2	1	2.0	0.0
199	1712+85.936	2	88	58.6	46.4	0.0	56.6	1	2.0	0.0
200	1709+04.149	2	88	60.7	47.7	0.0	58.6	1	2.0	0.0
201	1705+22.362	2	88	61.4	49.8	0.0	60.0	3	2.0	1.0
202	1701+40.574	2	88	62.0	51.8	0.0	60.0	3	2.0	0.0
203	1697+58.787	2	88	61.4	51.8	0.0	60.0	3	2.0	1.0
204	1693+76.999	2	88	56.6	49.8	0.0	55.9	9	2.0	1.0
205	1689+95.212	1	88	56.8	50.7	0.0	55.8	9	2.0	0.0
206	1686+13.424	1	90	61.2	52.6	0.0	59.9	11	2.1	0.0
207	1682+31.637	1	90	60.8	54.5	0.0	59.8	12	2.1	0.0
208	1678+49.849	1	90	56.7	53.6	0.0	56.2	13	2.1	0.0
209	1674+68.062	1	90	56.7	54.0	0.0	56.3	12	2.1	0.0
210	1670+86.275	1	91	60.9	57.2	0.0	60.3	10	2.0	0.0
211	1667+04.487	1	91	57.4	55.2	0.0	57.1	10	2.0	1.0
212	1663+22.700	1	91	57.3	55.2	0.0	57.0	10	2.0	0.0
213	1659+40.912	1	91	57.3	55.2	0.0	57.0	11	2.1	1.0
214	1655+59.125	1	91	61.2	57.7	0.0	60.6	11	2.1	1.0
215	1651+77.337	1	91	61.7	59.0	0.0	61.3	11	2.1	0.0
216	1647+95.550	1	91	61.8	59.0	0.0	61.4	11	2.1	0.0

Station Number	Station	Number of Lanes	Traffic Volume (vpd)	Speed Mean Cars (mph)	Speed Mean Trucks (mph)	Speed Mean RVs (mph)	Speed Mean All (mph)	Percent Following (%)	Platoon Size	Number of Passes
217	1644+13.762	1	91	57.5	53.6	0.0	56.9	11	2.1	0.0
218	1640+31.975	1	91	57.5	53.5	0.0	56.9	9	2.0	2.0
219	1636+50.187	1	91	57.5	53.5	0.0	56.9	9	2.0	0.0
220	1632+68.400	1	91	57.4	53.2	0.0	56.8	9	2.0	0.0
221	1628+86.613	1	89	57.5	53.7	0.0	57.0	9	2.0	1.0
222	1625+04.825	1	89	60.8	56.6	0.0	60.2	8	2.0	0.0
223	1621+23.038	1	89	62.0	58.7	0.0	61.6	8	2.0	0.0
224	1617+41.250	1	88	60.2	56.1	0.0	59.7	9	2.0	0.0
225	1613+59.463	1	88	57.4	53.4	0.0	56.8	9	2.0	0.0
226	1609+77.675	1	88	57.3	53.0	0.0	56.7	9	2.0	0.0
227	1605+95.888	1	88	61.5	54.1	0.0	60.4	10	2.0	0.0
228	1602+14.100	1	88	61.8	54.1	0.0	60.7	12	2.0	0.0
229	1598+32.313	2	88	60.7	52.5	0.0	59.3	3	2.0	0.0
230	1594+50.526	2	89	60.0	51.1	0.0	58.6	4	2.0	0.0
231	1590+68.738	2	89	60.0	49.1	0.0	58.6	6	2.0	3.0
232	1586+86.951	2	90	60.0	47.0	0.0	58.0	6	2.0	4.0
233	1583+05.163	2	90	60.0	45.7	0.0	57.3	10	2.0	0.0
234	1579+23.376	2	90	59.3	44.3	0.0	57.3	9	2.0	1.0
235	1575+41.588	2	89	59.3	43.6	0.0	57.3	9	2.1	1.0
236	1571+59.801	2	89	59.3	43.0	0.0	57.3	9	2.1	1.0
237	1567+78.013	2	89	59.3	42.3	0.0	56.6	10	2.1	1.0
238	1563+96.226	2	89	59.3	41.6	0.0	56.6	8	2.0	2.0
239	1560+14.438	2	89	59.3	41.6	0.0	56.6	7	2.0	2.0
240	1556+32.651	2	90	60.0	43.6	0.0	57.3	8	2.0	4.0
241	1552+50.864	2	90	60.7	46.4	0.0	58.0	10	2.1	2.0
242	1548+69.076	2	90	60.7	48.4	0.0	58.6	14	2.1	2.0
243	1544+87.289	1	90	62.0	52.6	0.0	60.5	13	2.1	0.0
244	1541+05.501	1	90	60.3	55.2	0.0	59.6	13	2.1	0.0
245	1537+23.714	1	90	58.0	54.6	0.0	57.5	11	2.0	0.0
246	1533+41.926	1	90	57.8	55.0	0.0	57.3	7	2.0	0.0
247	1529+60.139	1	90	57.8	54.9	0.0	57.3	8	2.0	0.0
248	1525+78.351	1	90	57.8	55.0	0.0	57.3	8	2.0	1.0
249	1521+96.564	1	91	57.7	54.9	0.0	57.3	8	2.0	0.0
250	1518+14.777	1	91	58.0	54.7	0.0	57.5	10	2.1	0.0
251	1514+32.989	1	91	60.7	53.9	0.0	59.6	9	2.0	0.0
252	1510+51.202	1	91	61.2	52.7	0.0	59.9	9	2.0	1.0
253	1506+69.414	1	91	61.0	51.7	0.0	59.6	9	2.0	0.0
254	1502+87.627	1	91	61.3	51.2	0.0	59.7	9	2.0	0.0
255	1499+05.839	1	91	61.8	52.3	0.0	60.3	7	2.0	0.0
256	1495+24.052	1	91	58.9	53.3	0.0	58.0	7	2.0	0.0
257	1491+42.264	1	92	57.2	53.8	0.0	56.7	9	2.1	1.0
258	1487+60.477	1	92	57.2	53.9	0.0	56.7	11	2.3	0.0
259	1483+78.689	1	93	57.2	54.2	0.0	56.7	12	2.2	0.0
260	1479+96.902	1	93	60.9	57.1	0.0	60.3	12	2.2	1.0
261	1476+15.115	1	93	61.9	59.2	0.0	61.5	13	2.2	0.0
262	1472+33.327	1	93	61.9	59.1	0.0	61.5	13	2.2	2.0
263	1468+51.540	1	93	61.7	58.3	0.0	61.2	13	2.2	0.0
264	1464+69.752	1	93	61.5	56.9	0.0	60.8	12	2.2	0.0
265	1460+87.965	1	93	61.3	55.6	0.0	60.4	11	2.3	1.0
266	1457+06.177	1	93	61.2	54.3	0.0	60.2	10	2.3	1.0

Station Number	Station	Number of Lanes	Traffic Volume (vpd)	Speed Mean Cars (mph)	Speed Mean Trucks (mph)	Speed Mean RVs (mph)	Speed Mean All (mph)	Percent Following (%)	Platoon Size	Number of Passes
267	1453+24.390	1	93	61.1	53.2	0.0	59.9	9	2.1	1.0
268	1449+42.602	1	93	61.3	52.4	0.0	60.0	10	2.1	0.0
269	1445+60.815	1	93	61.8	53.9	0.0	60.6	11	2.3	1.0
270	1441+79.028	1	92	61.9	56.8	0.0	61.2	12	2.0	0.0
271	1437+97.240	1	93	57.4	53.5	0.0	56.7	10	2.0	1.0
272	1434+15.453	1	93	57.4	53.5	0.0	56.8	11	2.3	1.0
273	1430+33.665	1	93	57.4	53.6	0.0	56.8	9	2.1	1.0
274	1426+51.878	1	93	61.0	54.7	0.0	59.9	9	2.1	1.0
275	1422+70.090	1	93	61.4	54.4	0.0	60.3	9	2.1	0.0
276	1418+88.303	1	93	57.1	51.9	0.0	56.2	9	2.0	0.0
277	1415+06.515	1	93	56.9	50.6	0.0	55.9	8	2.0	0.0
278	1411+24.728	1	93	57.1	52.5	0.0	56.4	8	2.0	0.0
279	1407+42.940	1	93	59.8	56.0	0.0	59.2	8	2.0	1.0
280	1403+61.153	1	93	62.0	58.4	0.0	61.5	9	2.0	1.0
281	1399+79.366	1	93	62.0	58.7	0.0	61.4	10	2.0	0.0
282	1395+97.578	1	93	61.8	57.8	0.0	61.2	10	2.0	0.0
283	1392+15.791	1	93	61.9	57.3	0.0	61.2	11	2.0	0.0
284	1388+34.003	1	93	62.0	58.4	0.0	61.4	11	2.0	0.0
285	1384+52.216	1	93	62.0	58.8	0.0	61.5	11	2.0	0.0
286	1380+70.428	1	93	62.0	59.2	0.0	61.5	12	2.0	0.0
287	1376+88.641	1	93	61.9	59.0	0.0	61.4	13	2.0	0.0
288	1373+06.853	1	93	57.6	53.9	0.0	57.0	13	2.0	0.0
289	1369+25.066	1	93	57.6	53.7	0.0	57.0	12	2.0	0.0
290	1365+43.279	1	95	57.7	53.5	0.0	57.0	13	2.0	1.0
291	1361+61.491	1	95	57.7	53.4	0.0	57.0	15	2.0	2.0
292	1357+79.704	1	95	60.6	55.1	0.0	59.7	15	2.0	0.0
293	1353+97.916	1	95	56.3	52.1	0.0	55.6	16	2.0	1.0
294	1350+16.129	1	95	56.7	52.1	0.0	55.9	16	2.0	1.0
295	1346+34.341	1	95	59.8	54.8	0.0	59.0	15	2.0	0.0
296	1342+52.554	1	95	57.3	53.7	0.0	56.8	15	2.0	0.0
297	1338+70.766	1	94	57.2	53.7	0.0	56.6	15	2.0	0.0
298	1334+88.979	1	94	59.3	54.8	0.0	58.6	15	2.0	0.0
299	1331+07.191	1	94	61.4	57.1	0.0	60.7	15	2.0	0.0
300	1327+25.404	1	95	61.6	58.4	0.0	61.1	16	2.0	0.0



*Interactive Highway Safety Design Model*

**Traffic Analysis Evaluation Report**

**P1\_6 Alignment Alternative**

January 5, 2018



## **Disclaimer**

The Interactive Highway Design Model (IHSDM) software is disseminated under the sponsorship of the Department of Transportation in the interest of information exchange. The United States Government assumes no liability for its content or use thereof. This document does not constitute a standard, specification, or regulation.

The United States Government does not endorse products or manufacturers. Trade and manufacturers' names may appear in this software and documentation only because they are considered essential to the objective of the software.

## **Limited Warranty and Limitations of Remedies**

This software product is provided "as-is," without warranty of any kind-either expressed or implied (but not limited to the implied warranties of merchantability and fitness for a particular purpose). The FHWA do not warrant that the functions contained in the software will meet the end-user's requirements or that the operation of the software will be uninterrupted and error-free.

Under no circumstances will the FHWA be liable to the end-user for any damages or claimed lost profits, lost savings, or other incidental or consequential damages rising out of the use or inability to use the software (even if these organizations have been advised of the possibility of such damages), or for any claim by any other party.

## **Notice**

The use of the IHSDM software is being done strictly on a voluntary basis. In exchange for provision of IHSDM, the user agrees that the Federal Highway Administration (FHWA), U.S. Department of Transportation and any other agency of the Federal Government shall not be responsible for any errors, damage or other liability that may result from any and all use of the software, including installation and testing of the software. The user further agrees to hold the FHWA and the Federal Government harmless from any resulting liability. The user agrees that this hold harmless provision shall flow to any person to whom or any entity to which the user provides the IHSDM software. It is the user's full responsibility to inform any person to whom or any entity to which it provides the IHSDM software of this hold harmless provision.

---

---

## Table of Contents

<b>Report Overview</b> .....	<b>1</b>
<b>Traffic Analysis Graphical Results</b> .....	<b>2</b>
<b>Simulation Input Data</b> .....	<b>7</b>
<b>Simulation Output Summary</b> .....	<b>9</b>
<b>Simulation Station Summaries</b> .....	<b>10</b>

## List of Tables

Table Simulation Parameters .....	7
Table Random Number Generator Seeds .....	7
Table Traffic Input Data .....	8
Table Section Summary .....	9
Table Station Summary (Increasing) .....	10
Table Station Summary (Decreasing) .....	16

## List of Figures

Figure Graphical Results (Increasing) .....	3
Figure Graphical Results (Decreasing) .....	5

## **Report Overview**

**Report Generated:** Jan 5, 2018 10:02 AM

**Report Template:** System: Multi-Page [System] (tam2, Oct 9, 2017 1:45 PM)

**Evaluation Date:** Fri Jan 05 09:53:25 AKST 2018

**IHSDM Version:** v13.0.0 (Sep 13, 2017)

**Traffic Analysis Module:** v1.6.0 (Mar 24, 2017)

**User Name:** RaeAnne Hebnes

**Organization Name:** Michael Baker International

**Phone:**

**E-Mail:**

**Project Title:** Parks 305 - 325 v2

**Project Comment:** Created using wizard

**Project Unit System:** U.S. Customary

**Highway Title:** Alignment P1\_6\_1dec2017

**Highway Comment:** Alignment P1\_1dec2017with 6% max grade

**Highway Version:** 1

**Evaluation Title:** Evaluation 8

**Evaluation Comment:** Created Fri Jan 05 09:51:03 AKST 2018

**Minimum Station:** 1327+09.000

**Maximum Station:** 2469+47.035

**Configuration Name:** Default

## **Traffic Analysis Graphical Results**

[[Graphical Results in the Engineer's Manual](#)]

Figure 1 below displays the graphical results of the Traffic Analysis Module evaluation for the increasing direction of travel.



Traffic Analysis Summary, Increasing Direction of Travel  
 Project: Parks 305 - 325 v2, Evaluation: Evaluation 8  
 Highway: Alignment P1\_6\_1 dec2017

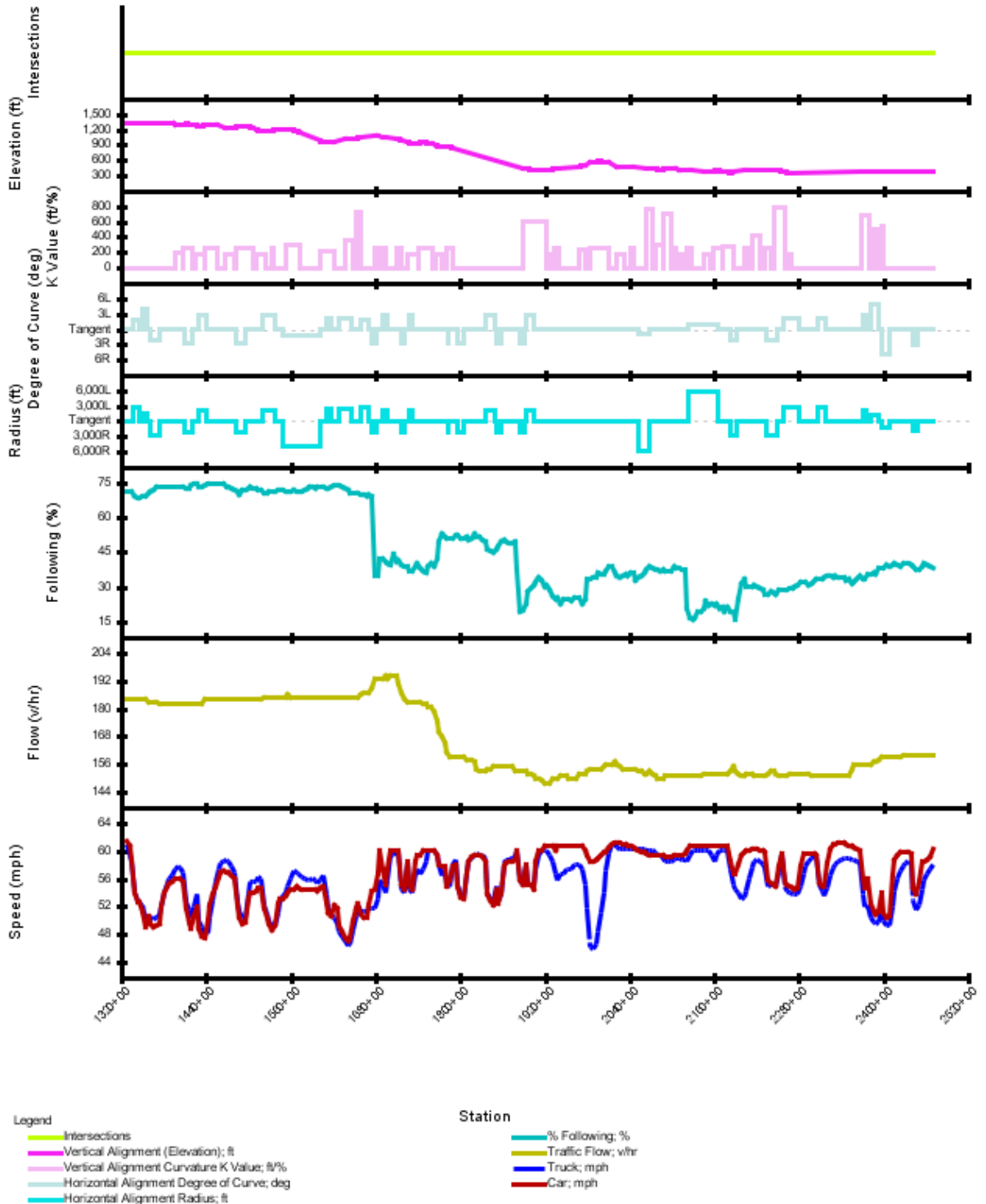

Figure 1. Graphical Results (Increasing)

Figure 2 below displays the graphical results of the Traffic Analysis Module evaluation for the decreasing direction of travel.

Traffic Analysis Summary, Decreasing Direction of Travel  
 Project: Parks 305 - 325 v2, Evaluation: Evaluation 8  
 Highway: Alignment P1\_6\_1 dec2017

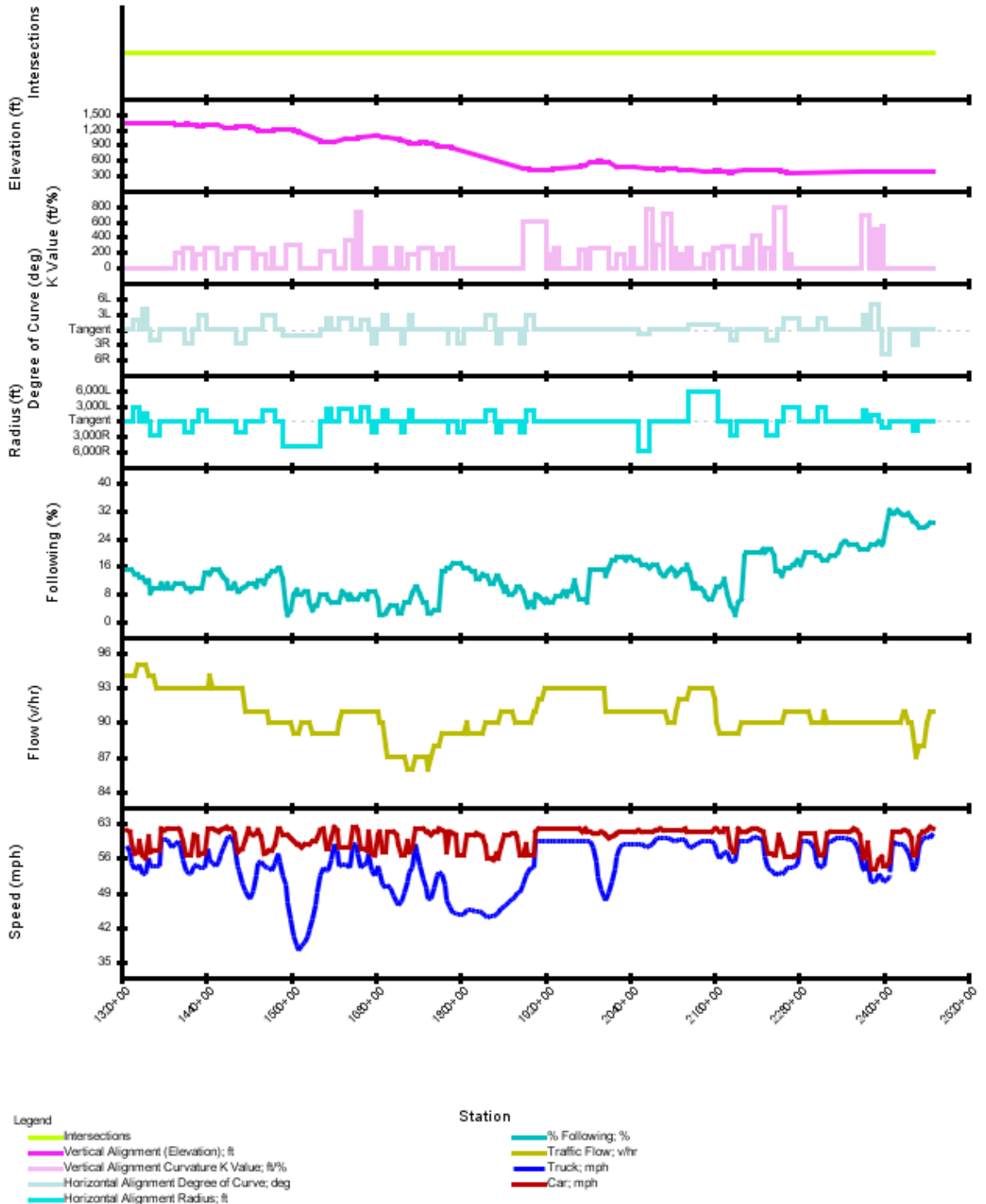

Figure 2. Graphical Results (Decreasing)



## Simulation Input Data

[Traffic Input Data in the Engineer's Manual]

**Table 1. Simulation Parameters**

Simulation Time (min)	60
Warm-up Time (min)	10
Total Time (min)	70
Computer Time (sec)	1
Test Road Length (mi)	21.6360

**Table 2. Random Number Generator Seeds**

Description	Value
Entering Traffic in Platoons / Direction of Increasing Stations	81250132
Desired Speed / Direction of Increasing Stations	70867724
Entering Traffic in Platoons / Direction of Decreasing Stations	33333334
Desired Speed / Direction of Decreasing Stations	16532240
Passing Decisions	52338126

**Table 3. Traffic Input Data**

Direction of Travel	Flow Rate (vph)	Distribution Cars (%)	Distribution Trucks (%)	Distribution RVs (%)	Mean Desired Speed Cars (mph)	Mean Desired Speed Trucks (mph)	Mean Desired Speed RVs (mph)	Desired Speed Standard Deviation Cars (mph)	Desired Speed Standard Deviation Trucks (mph)	Desired Speed Standard Deviation RVs (mph)	Entering Traffic in Platoons (%)	No Passing Zone (%)
Increasing	170	83	17	0	61.5	59.5	59.5	5.0	3.5	4.0	65	0
Decreasing	91	83	17	0	61.5	59.5	59.5	5.0	3.5	4.0	35	0



## Simulation Output Summary

[Section Summary in the Engineer's Manual]

Table 4 below includes the traffic output data table for the main road section. The table reports the actual simulated flow rate, percent time spent following, average speed, trip time, traffic delay, geometric delay, total delay, number of passes, vehicle-distance traveled, and vehicle-hours of travel. These simulation outputs are reported for each direction and both directions combined.

**Table 4. Section Summary**

Direction of Travel	Flow Rate from Simulation (vph)	Percent Time Spent Following (%)	Average Travel Speed (mph)	Trip Time (min/veh)	Traffic Delay (min/veh)	Geometric Delay (min/veh)	Total Delay (min/v eh)	Number of Passes	Distance Traveled (mi)	Total Travel Time (veh-hrs)
Increasing	167	50	55.6	23.1	0.9	0.8	1.7	499	3,585.2	64.5
Decreasing	91	13	58.4	22.2	-0.4	1.2	0.8	175	1,962.6	33.6
Combined	258	37	56.6	22.8	0.5	0.9	1.4	674	5,547.8	98.1

## Simulation Station Summaries

[Station Summary in the Engineer's Manual]

Table 5 below reports spot traffic operational data collected by the simulation at each data collection station for travel in direction of increasing stations. These data are analogous to data that would be collected by a traffic data recorder placed at the specified location on the highway during the simulation time. The data include hourly traffic volume; measured mean speed of cars, trucks, and recreational vehicles; mean and standard deviation speed for all vehicles combined; percent of vehicles following at a headway of less than 4 seconds; the average platoon size; and number of passes. A separate table is produced for each direction of travel. The data in this station summary data tables are used to create graphs.

**Table 5. Station Summary (Increasing)**

Station Number	Station	Number of Lanes	Traffic Volume (vpd)	Speed Mean Cars (mph)	Speed Mean Trucks (mph)	Speed Mean RVs (mph)	Speed Mean All (mph)	Percent Following (%)	Platoon Size	Number of Passes
1	1327+25.404	1	184	61.4	61.0	0.0	61.4	71	5.5	0.0
2	1331+07.361	1	184	60.7	59.5	0.0	60.5	71	5.5	0.0
3	1334+89.319	1	184	58.8	58.4	0.0	58.8	71	5.5	0.0
4	1338+71.276	1	184	54.0	54.1	0.0	54.0	69	4.6	0.0
5	1342+53.233	1	184	52.6	52.8	0.0	52.6	68	4.6	0.0
6	1346+35.190	1	184	52.6	52.4	0.0	52.6	68	4.6	0.0
7	1350+17.148	1	184	51.3	52.1	0.0	51.4	70	4.9	0.0
8	1353+99.105	1	184	49.0	50.0	0.0	49.2	70	4.9	0.0
9	1357+81.062	1	183	50.7	50.7	0.0	50.7	70	4.9	0.0
10	1361+63.020	1	183	49.4	50.3	0.0	49.5	72	5.1	0.0
11	1365+44.977	1	183	49.0	50.2	0.0	49.2	72	5.3	0.0
12	1369+26.934	1	183	49.3	50.3	0.0	49.4	73	5.6	0.0
13	1373+08.891	1	182	49.5	50.8	0.0	49.6	74	5.6	0.0
14	1376+90.849	1	182	52.0	51.9	0.0	52.0	73	5.4	0.0
15	1380+72.806	1	182	54.1	54.1	0.0	54.1	73	5.4	1.0
16	1384+54.763	1	182	54.8	55.4	0.0	54.9	73	5.4	0.0
17	1388+36.720	1	182	55.3	56.1	0.0	55.4	73	5.4	0.0
18	1392+18.678	1	182	55.6	56.5	0.0	55.7	73	5.4	0.0
19	1396+00.635	1	182	56.0	57.4	0.0	56.2	73	5.4	0.0
20	1399+82.592	1	182	56.0	57.8	0.0	56.3	74	5.6	0.0
21	1403+64.550	1	182	56.0	57.6	0.0	56.3	73	5.4	0.0
22	1407+46.507	1	182	55.6	56.9	0.0	55.8	73	5.4	0.0
23	1411+28.464	1	182	51.7	52.6	0.0	51.8	72	5.3	0.0
24	1415+10.421	1	182	49.8	51.5	0.0	50.0	72	5.3	0.0
25	1418+92.379	1	182	48.8	50.4	0.0	49.0	74	5.7	0.0
26	1422+74.336	1	182	50.7	52.0	0.0	50.9	75	5.9	0.0
27	1426+56.293	1	182	52.0	53.7	0.0	52.2	75	5.9	0.0
28	1430+38.251	1	182	48.8	50.0	0.0	49.0	74	5.5	0.0
29	1434+20.208	1	182	47.8	49.1	0.0	47.9	74	5.5	0.0
30	1438+02.165	1	184	47.4	48.1	0.0	47.5	74	5.5	0.0
31	1441+84.122	1	184	50.0	48.2	0.0	49.8	74	5.7	0.0
32	1445+66.080	1	184	52.3	50.3	0.0	52.0	74	5.7	0.0
33	1449+48.037	1	184	53.7	52.8	0.0	53.7	74	5.9	0.0
34	1453+29.994	1	184	55.0	55.5	0.0	55.1	75	6.1	0.0

Station Number	Station	Number of Lanes	Traffic Volume (vpd)	Speed Mean Cars (mph)	Speed Mean Trucks (mph)	Speed Mean RVs (mph)	Speed Mean All (mph)	Percent Following (%)	Platoon Size	Number of Passes
35	1457+11.952	1	184	56.3	57.4	0.0	56.5	75	6.1	0.0
36	1460+93.909	1	184	56.9	58.3	0.0	57.1	75	5.8	3.0
37	1464+75.866	1	184	57.1	58.6	0.0	57.3	74	5.6	0.0
38	1468+57.823	1	184	56.9	58.8	0.0	57.2	73	5.1	3.0
39	1472+39.781	1	184	56.9	58.6	0.0	57.1	73	5.1	1.0
40	1476+21.738	1	184	56.5	57.9	0.0	56.7	73	5.1	0.0
41	1480+03.695	1	184	56.1	57.0	0.0	56.2	72	5.4	0.0
42	1483+85.652	1	184	52.2	52.6	0.0	52.2	71	5.4	0.0
43	1487+67.610	1	184	50.5	51.2	0.0	50.6	70	5.2	0.0
44	1491+49.567	1	184	49.4	50.3	0.0	49.5	72	5.2	0.0
45	1495+31.524	1	184	49.7	50.3	0.0	49.8	72	5.3	0.0
46	1499+13.482	1	184	53.0	53.7	0.0	53.1	73	5.6	0.0
47	1502+95.439	1	184	54.0	55.6	0.0	54.2	73	5.7	0.0
48	1506+77.396	1	184	54.1	55.6	0.0	54.3	73	5.5	0.0
49	1510+59.353	1	184	54.3	55.6	0.0	54.5	73	5.5	1.0
50	1514+41.311	1	184	54.6	56.2	0.0	54.8	72	5.3	0.0
51	1518+23.268	1	184	54.7	56.1	0.0	54.8	72	5.1	0.0
52	1522+05.225	1	185	51.7	52.1	0.0	51.8	71	5.1	0.0
53	1525+87.183	1	185	50.5	50.9	0.0	50.5	71	5.1	0.0
54	1529+69.140	1	185	49.6	49.9	0.0	49.6	71	5.3	0.0
55	1533+51.097	1	185	48.7	49.0	0.0	48.7	71	5.3	0.0
56	1537+33.054	1	185	49.3	49.2	0.0	49.2	71	5.3	0.0
57	1541+15.012	1	185	52.5	51.1	0.0	52.3	72	5.4	1.0
58	1544+96.969	1	185	53.1	52.6	0.0	53.0	72	5.4	1.0
59	1548+78.926	1	185	53.2	53.5	0.0	53.3	72	5.4	0.0
60	1552+60.883	1	185	53.6	54.0	0.0	53.7	71	5.4	0.0
61	1556+42.841	1	186	54.1	55.0	0.0	54.3	72	5.6	0.0
62	1560+24.798	1	185	54.5	56.1	0.0	54.7	71	5.7	0.0
63	1564+06.755	1	185	54.5	57.1	0.0	54.9	72	5.9	0.0
64	1567+88.713	1	185	54.8	56.9	0.0	55.1	71	5.7	0.0
65	1571+70.670	1	185	54.7	56.7	0.0	55.0	71	5.5	0.0
66	1575+52.627	1	185	54.5	56.2	0.0	54.8	71	5.5	0.0
67	1579+34.584	1	185	54.5	56.0	0.0	54.7	72	5.4	0.0
68	1583+16.542	1	185	54.5	55.9	0.0	54.7	72	5.6	0.0
69	1586+98.499	1	185	54.5	55.8	0.0	54.7	73	5.8	0.0
70	1590+80.456	1	185	54.5	56.0	0.0	54.8	73	5.8	0.0
71	1594+62.414	1	185	54.5	55.7	0.0	54.7	72	5.6	0.0
72	1598+44.371	1	185	54.3	55.3	0.0	54.5	73	5.8	0.0
73	1602+26.328	1	185	54.6	55.8	0.0	54.8	73	5.8	0.0
74	1606+08.285	1	185	54.9	56.5	0.0	55.1	73	5.8	0.0
75	1609+90.243	1	185	52.7	53.7	0.0	52.8	72	5.5	0.0
76	1613+72.200	1	185	51.0	51.8	0.0	51.1	72	5.5	0.0
77	1617+54.157	1	185	50.6	50.8	0.0	50.6	73	5.7	0.0
78	1621+36.115	1	185	52.2	50.5	0.0	52.0	74	6.1	2.0
79	1625+18.072	1	185	51.8	49.6	0.0	51.5	74	6.1	0.0
80	1629+00.029	1	185	49.2	48.4	0.0	49.1	74	6.1	0.0
81	1632+81.986	1	185	48.3	47.7	0.0	48.3	74	5.9	0.0
82	1636+63.944	1	185	47.5	47.1	0.0	47.5	72	5.6	0.0
83	1640+45.901	1	185	47.0	46.4	0.0	46.9	72	5.8	0.0
84	1644+27.858	1	185	47.5	46.6	0.0	47.4	70	5.2	0.0

Station Number	Station	Number of Lanes	Traffic Volume (vpd)	Speed Mean Cars (mph)	Speed Mean Trucks (mph)	Speed Mean RVs (mph)	Speed Mean All (mph)	Percent Following (%)	Platoon Size	Number of Passes
85	1648+09.815	1	185	49.9	48.5	0.0	49.8	71	5.2	0.0
86	1651+91.773	1	185	51.8	50.7	0.0	51.6	71	5.2	1.0
87	1655+73.730	1	185	52.4	52.2	0.0	52.4	70	5.2	0.0
88	1659+55.687	1	186	50.9	51.3	0.0	50.9	70	5.2	0.0
89	1663+37.645	1	187	50.5	51.3	0.0	50.7	70	5.1	0.0
90	1667+19.602	1	187	50.4	51.3	0.0	50.5	70	5.1	0.0
91	1671+01.559	1	187	52.3	51.8	0.0	52.2	70	5.2	0.0
92	1674+83.516	1	189	54.2	51.8	0.0	53.9	69	5.0	0.0
93	1678+65.474	2	193	54.5	51.8	0.0	53.9	35	2.8	1.0
94	1682+47.431	2	193	56.6	53.2	0.0	55.9	35	2.7	16.0
95	1686+29.388	2	193	60.0	55.9	0.0	59.3	42	2.6	11.0
96	1690+11.346	2	193	57.3	55.2	0.0	57.3	42	2.7	11.0
97	1693+93.303	2	194	55.2	53.9	0.0	55.2	41	2.6	15.0
98	1697+75.260	2	193	57.3	55.9	0.0	57.3	40	2.8	11.0
99	1701+57.217	2	194	60.0	59.3	0.0	60.0	40	2.8	13.0
100	1705+39.175	2	194	60.0	59.3	0.0	60.0	44	3.0	9.0
101	1709+21.132	2	194	60.0	60.0	0.0	60.0	41	2.8	6.0
102	1713+03.089	2	191	60.0	60.0	0.0	60.0	41	2.9	11.0
103	1716+85.047	2	187	55.2	54.5	0.0	55.2	40	3.0	4.0
104	1720+67.004	2	184	54.5	53.9	0.0	54.5	39	3.1	12.0
105	1724+48.961	2	183	58.6	58.6	0.0	58.6	39	3.3	6.0
106	1728+30.918	2	183	55.2	54.5	0.0	55.2	37	3.1	11.0
107	1732+12.876	2	183	54.5	53.9	0.0	54.5	37	3.5	3.0
108	1735+94.833	2	183	58.6	56.6	0.0	58.6	39	3.3	5.0
109	1739+76.790	2	183	59.3	57.3	0.0	59.3	40	3.1	6.0
110	1743+58.747	2	183	59.3	56.6	0.0	59.3	38	2.9	4.0
111	1747+40.705	2	182	60.0	57.3	0.0	59.3	37	2.9	7.0
112	1751+22.662	2	182	60.0	58.6	0.0	60.0	36	2.9	5.0
113	1755+04.619	2	181	60.0	60.0	0.0	60.0	39	3.1	6.0
114	1758+86.577	2	181	60.0	60.0	0.0	60.0	40	3.4	4.0
115	1762+68.534	2	179	60.0	60.0	0.0	60.0	39	3.1	6.0
116	1766+50.491	2	175	59.3	59.3	0.0	59.3	42	3.6	9.0
117	1770+32.448	2	170	58.0	58.0	0.0	58.0	50	3.6	9.0
118	1774+14.406	1	168	57.9	56.5	0.0	57.8	53	3.9	3.0
119	1777+96.363	1	165	57.8	57.2	0.0	57.7	52	3.8	0.0
120	1781+78.320	1	161	54.8	54.8	0.0	54.8	51	3.6	0.0
121	1785+60.278	1	159	55.8	54.8	0.0	55.7	51	3.8	0.0
122	1789+42.235	1	159	57.9	58.1	0.0	58.0	51	3.8	0.0
123	1793+24.192	1	159	58.0	58.7	0.0	58.1	52	3.5	0.0
124	1797+06.149	1	159	54.8	55.1	0.0	54.8	52	3.4	0.0
125	1800+88.107	1	159	53.3	53.5	0.0	53.3	51	3.5	0.0
126	1804+70.064	1	159	53.0	53.2	0.0	53.0	51	3.5	0.0
127	1808+52.021	1	158	57.0	56.9	0.0	57.0	52	3.5	0.0
128	1812+33.979	1	158	58.6	58.4	0.0	58.5	51	3.4	3.0
129	1816+15.936	1	158	59.1	59.0	0.0	59.0	51	3.4	2.0
130	1819+97.893	1	157	59.5	59.5	0.0	59.5	53	3.4	3.0
131	1823+79.850	1	154	59.5	59.7	0.0	59.6	52	3.4	1.0
132	1827+61.808	1	153	59.3	59.5	0.0	59.4	52	3.5	1.0
133	1831+43.765	1	153	59.1	59.4	0.0	59.2	50	3.5	0.0
134	1835+25.722	1	153	58.5	59.0	0.0	58.6	50	3.4	0.0

Station Number	Station	Number of Lanes	Traffic Volume (vpd)	Speed Mean Cars (mph)	Speed Mean Trucks (mph)	Speed Mean RVs (mph)	Speed Mean All (mph)	Percent Following (%)	Platoon Size	Number of Passes
135	1839+07.679	1	154	53.7	53.9	0.0	53.7	46	3.2	0.0
136	1842+89.637	1	154	52.8	53.1	0.0	52.8	46	3.1	0.0
137	1846+71.594	1	155	52.2	52.7	0.0	52.3	45	3.1	0.0
138	1850+53.551	1	155	54.5	54.8	0.0	54.5	46	3.3	0.0
139	1854+35.509	1	155	52.5	52.6	0.0	52.5	48	3.2	0.0
140	1858+17.466	1	155	54.1	53.8	0.0	54.1	50	3.1	0.0
141	1861+99.423	1	155	57.8	58.2	0.0	57.8	50	3.2	1.0
142	1865+81.380	1	155	58.2	58.8	0.0	58.3	50	3.1	1.0
143	1869+63.338	1	155	58.5	58.8	0.0	58.6	49	3.0	1.0
144	1873+45.295	1	155	58.6	59.0	0.0	58.7	49	3.0	1.0
145	1877+27.252	1	153	58.8	59.1	0.0	58.8	50	3.2	0.0
146	1881+09.210	2	153	60.0	60.0	0.0	60.0	37	3.0	0.0
147	1884+91.167	2	153	55.9	55.9	0.0	55.9	20	2.5	0.0
148	1888+73.124	2	153	55.2	55.2	0.0	55.2	20	2.2	7.0
149	1892+55.081	2	153	58.0	58.0	0.0	58.0	23	2.3	12.0
150	1896+37.039	2	152	55.2	55.2	0.0	55.2	28	2.5	7.0
151	1900+18.996	2	152	55.2	55.2	0.0	55.2	30	2.3	9.0
152	1904+00.953	2	151	54.5	55.2	0.0	54.5	31	2.5	7.0
153	1907+82.910	2	150	58.6	57.3	0.0	58.0	32	2.5	8.0
154	1911+64.868	2	150	60.0	59.3	0.0	60.0	34	2.5	5.0
155	1915+46.825	2	149	60.0	60.0	0.0	60.0	33	2.5	1.0
156	1919+28.782	2	148	60.7	60.0	0.0	60.0	30	2.5	4.0
157	1923+10.740	2	148	60.7	60.0	0.0	60.7	31	2.5	2.0
158	1926+92.697	2	148	60.7	59.3	0.0	60.7	29	2.5	4.0
159	1930+74.654	2	150	60.7	58.6	0.0	60.0	26	2.4	4.0
160	1934+56.611	2	150	60.0	56.6	0.0	60.0	25	2.5	2.0
161	1938+38.569	2	150	60.7	55.9	0.0	60.0	25	2.6	6.0
162	1942+20.526	2	151	60.7	56.6	0.0	60.0	22	2.5	0.0
163	1946+02.483	2	151	60.7	56.6	0.0	60.0	24	2.6	3.0
164	1949+84.441	2	151	60.7	57.3	0.0	60.0	24	2.5	7.0
165	1953+66.398	2	150	60.7	57.3	0.0	60.0	25	2.4	1.0
166	1957+48.355	2	150	60.7	57.3	0.0	60.0	24	2.3	1.0
167	1961+30.312	2	150	60.7	58.0	0.0	60.0	25	2.3	2.0
168	1965+12.270	2	150	60.7	58.0	0.0	60.0	25	2.3	2.0
169	1968+94.227	2	152	60.7	58.0	0.0	60.0	26	2.3	6.0
170	1972+76.184	2	152	60.7	57.3	0.0	60.0	23	2.3	4.0
171	1976+58.142	2	152	60.0	55.2	0.0	59.3	25	2.6	3.0
172	1980+40.099	2	153	59.3	51.8	0.0	58.0	33	2.8	5.0
173	1984+22.056	1	154	58.4	46.2	0.0	56.5	34	2.9	21.0
174	1988+04.013	1	154	58.4	45.8	0.0	56.5	34	3.0	2.0
175	1991+85.971	1	154	58.7	46.6	0.0	56.9	34	2.9	0.0
176	1995+67.928	1	154	59.0	48.4	0.0	57.5	36	3.0	0.0
177	1999+49.885	1	154	59.5	51.0	0.0	58.2	36	3.0	0.0
178	2003+31.842	1	155	59.8	54.1	0.0	59.0	36	3.0	0.0
179	2007+13.800	1	156	59.9	57.1	0.0	59.5	37	3.1	0.0
180	2010+95.757	1	156	60.5	59.7	0.0	60.3	39	3.0	0.0
181	2014+77.714	1	156	60.9	60.9	0.0	60.9	39	3.0	2.0
182	2018+59.672	1	157	61.2	60.9	0.0	61.2	36	3.0	3.0
183	2022+41.629	1	156	61.2	60.5	0.0	61.0	35	2.8	2.0
184	2026+23.586	1	155	61.1	60.2	0.0	61.0	34	3.0	3.0

Station Number	Station	Number of Lanes	Traffic Volume (vpd)	Speed Mean Cars (mph)	Speed Mean Trucks (mph)	Speed Mean RVs (mph)	Speed Mean All (mph)	Percent Following (%)	Platoon Size	Number of Passes
185	2030+05.543	1	154	61.0	60.2	0.0	60.9	35	3.0	1.0
186	2033+87.501	1	154	60.9	60.2	0.0	60.8	36	3.0	2.0
187	2037+69.458	1	154	60.8	60.2	0.0	60.7	35	3.0	2.0
188	2041+51.415	1	154	60.8	60.3	0.0	60.7	36	3.0	0.0
189	2045+33.373	1	154	60.5	60.2	0.0	60.5	36	3.0	0.0
190	2049+15.330	1	154	60.3	60.3	0.0	60.3	33	3.0	0.0
191	2052+97.287	1	153	60.1	60.3	0.0	60.1	34	2.9	0.0
192	2056+79.244	1	153	59.9	60.3	0.0	60.0	35	3.2	0.0
193	2060+61.202	1	152	59.9	60.3	0.0	59.9	36	3.2	0.0
194	2064+43.159	1	152	59.6	60.1	0.0	59.7	38	3.2	0.0
195	2068+25.116	1	153	59.5	60.1	0.0	59.6	39	3.2	0.0
196	2072+07.074	1	152	59.5	60.1	0.0	59.6	38	3.1	0.0
197	2075+89.031	1	151	59.3	59.8	0.0	59.4	38	3.0	0.0
198	2079+70.988	1	150	59.3	59.5	0.0	59.3	37	3.1	1.0
199	2083+52.945	1	150	59.4	59.4	0.0	59.4	37	3.1	1.0
200	2087+34.903	1	150	59.4	58.9	0.0	59.3	37	3.1	1.0
201	2091+16.860	1	151	59.2	58.6	0.0	59.1	37	3.1	0.0
202	2094+98.817	1	151	59.1	58.6	0.0	59.0	37	3.1	0.0
203	2098+80.774	1	151	59.1	58.6	0.0	59.0	37	3.1	0.0
204	2102+62.732	1	151	59.3	58.8	0.0	59.2	39	3.3	0.0
205	2106+44.689	1	151	59.4	59.0	0.0	59.4	38	3.2	0.0
206	2110+26.646	1	151	59.5	59.0	0.0	59.4	38	3.1	0.0
207	2114+08.604	1	151	59.5	58.7	0.0	59.4	38	3.0	0.0
208	2117+90.561	1	151	59.7	58.8	0.0	59.5	38	3.0	0.0
209	2121+72.518	2	151	60.0	58.6	0.0	60.0	20	2.4	0.0
210	2125+54.475	2	151	60.7	59.3	0.0	60.7	17	2.3	0.0
211	2129+36.433	2	151	60.7	60.0	0.0	60.7	16	2.2	3.0
212	2133+18.390	2	151	60.7	60.0	0.0	60.7	17	2.1	5.0
213	2137+00.347	2	151	60.7	60.0	0.0	60.7	19	2.2	4.0
214	2140+82.305	2	151	60.7	60.0	0.0	60.7	19	2.3	6.0
215	2144+64.262	2	152	60.7	60.0	0.0	60.7	20	2.3	6.0
216	2148+46.219	2	152	60.7	60.0	0.0	60.7	24	2.3	6.0
217	2152+28.176	2	152	60.7	60.0	0.0	60.7	22	2.2	3.0
218	2156+10.134	2	152	60.7	59.3	0.0	60.7	23	2.2	4.0
219	2159+92.091	2	152	60.7	58.6	0.0	60.7	22	2.3	2.0
220	2163+74.048	2	152	60.7	59.3	0.0	60.7	23	2.3	2.0
221	2167+56.006	2	152	60.7	60.0	0.0	60.7	20	2.2	1.0
222	2171+37.963	2	152	60.7	60.0	0.0	60.7	22	2.3	2.0
223	2175+19.920	2	152	60.7	60.0	0.0	60.7	19	2.3	4.0
224	2179+01.877	2	152	60.7	60.0	0.0	60.7	22	2.5	3.0
225	2182+83.835	2	153	58.6	57.3	0.0	58.6	20	2.7	4.0
226	2186+65.792	2	155	56.6	55.2	0.0	56.6	19	2.4	5.0
227	2190+47.749	2	153	56.6	54.5	0.0	55.9	16	2.3	3.0
228	2194+29.706	2	152	58.0	53.9	0.0	57.3	25	2.6	7.0
229	2198+11.664	2	151	59.3	53.2	0.0	58.6	32	2.6	1.0
230	2201+93.621	1	151	59.9	53.3	0.0	58.8	34	2.6	4.0
231	2205+75.578	1	152	60.0	54.3	0.0	59.1	30	2.6	0.0
232	2209+57.536	1	152	60.1	56.0	0.0	59.5	30	2.6	0.0
233	2213+39.493	1	152	60.3	57.7	0.0	59.9	30	2.6	1.0
234	2217+21.450	1	151	60.3	58.4	0.0	60.0	31	2.7	0.0



Station Number	Station	Number of Lanes	Traffic Volume (vpd)	Speed Mean Cars (mph)	Speed Mean Trucks (mph)	Speed Mean RVs (mph)	Speed Mean All (mph)	Percent Following (%)	Platoon Size	Number of Passes
235	2221+03.407	1	151	60.2	58.7	0.0	60.0	30	2.6	0.0
236	2224+85.365	1	151	60.1	58.6	0.0	59.9	30	2.6	0.0
237	2228+67.322	1	151	60.0	58.0	0.0	59.7	28	2.6	0.0
238	2232+49.279	1	151	59.8	57.6	0.0	59.5	26	2.6	0.0
239	2236+31.237	1	152	55.7	54.8	0.0	55.6	27	2.6	0.0
240	2240+13.194	1	153	55.4	55.2	0.0	55.4	28	2.7	0.0
241	2243+95.151	1	153	55.2	55.2	0.0	55.2	28	2.8	0.0
242	2247+77.108	1	152	55.0	55.0	0.0	55.0	27	2.8	0.0
243	2251+59.066	1	151	57.9	57.0	0.0	57.8	28	2.9	0.0
244	2255+41.023	1	151	59.7	59.7	0.0	59.7	28	2.9	0.0
245	2259+22.980	1	151	55.5	54.9	0.0	55.4	29	2.8	0.0
246	2263+04.938	1	151	55.1	54.3	0.0	55.0	29	2.7	0.0
247	2266+86.895	1	152	54.9	53.9	0.0	54.8	30	2.7	0.0
248	2270+68.852	1	152	54.7	53.8	0.0	54.5	30	2.7	0.0
249	2274+50.809	1	152	54.5	53.8	0.0	54.5	30	2.8	0.0
250	2278+32.767	1	152	54.6	53.7	0.0	54.5	31	2.7	0.0
251	2282+14.724	1	152	57.8	54.8	0.0	57.3	32	2.9	0.0
252	2285+96.681	1	152	59.6	56.7	0.0	59.1	32	2.9	2.0
253	2289+78.638	1	152	59.7	57.8	0.0	59.5	32	2.9	0.0
254	2293+60.596	1	152	59.7	58.5	0.0	59.5	31	2.7	1.0
255	2297+42.553	1	151	59.7	58.9	0.0	59.6	32	2.8	0.0
256	2301+24.510	1	151	59.7	59.3	0.0	59.7	33	2.8	0.0
257	2305+06.468	1	151	59.3	59.3	0.0	59.3	34	2.7	0.0
258	2308+88.425	1	151	55.3	55.2	0.0	55.3	34	2.6	0.0
259	2312+70.382	1	151	54.8	54.2	0.0	54.8	34	2.5	0.0
260	2316+52.339	1	151	55.0	53.6	0.0	54.8	34	2.6	0.0
261	2320+34.297	1	151	58.3	54.7	0.0	57.8	35	2.7	1.0
262	2324+16.254	1	151	60.4	56.4	0.0	59.8	35	2.6	3.0
263	2327+98.211	1	151	61.0	57.5	0.0	60.4	34	2.5	4.0
264	2331+80.169	1	151	61.0	58.1	0.0	60.5	35	2.6	4.0
265	2335+62.126	1	151	61.1	58.5	0.0	60.7	34	2.5	2.0
266	2339+44.083	1	151	61.1	58.8	0.0	60.8	34	2.5	3.0
267	2343+26.040	1	151	61.1	59.0	0.0	60.8	34	2.5	1.0
268	2347+07.998	1	151	61.0	59.0	0.0	60.6	33	2.4	0.0
269	2350+89.955	1	151	60.8	58.9	0.0	60.5	34	2.5	0.0
270	2354+71.912	1	154	60.7	58.8	0.0	60.4	31	2.5	2.0
271	2358+53.869	1	156	60.5	58.8	0.0	60.2	32	2.6	1.0
272	2362+35.827	1	156	60.3	58.5	0.0	60.0	33	2.6	0.0
273	2366+17.784	1	156	60.0	58.2	0.0	59.7	35	2.7	0.0
274	2369+99.741	1	156	56.0	53.8	0.0	55.7	33	2.7	0.0
275	2373+81.699	1	156	54.6	51.9	0.0	54.2	33	2.7	0.0
276	2377+63.656	1	156	56.0	52.1	0.0	55.4	35	2.7	0.0
277	2381+45.613	1	156	52.5	50.3	0.0	52.2	35	2.7	0.0
278	2385+27.570	1	157	51.3	49.8	0.0	51.1	36	2.8	0.0
279	2389+09.528	1	157	50.8	49.4	0.0	50.6	36	2.8	0.0
280	2392+91.485	1	158	51.4	49.8	0.0	51.1	38	2.9	0.0
281	2396+73.442	1	159	54.1	51.6	0.0	53.7	38	2.9	0.0
282	2400+55.400	1	159	51.0	49.9	0.0	50.8	38	2.8	0.0
283	2404+37.357	1	159	50.5	49.2	0.0	50.3	40	2.9	0.0
284	2408+19.314	1	159	50.7	49.2	0.0	50.5	39	2.8	0.0

Station Number	Station	Number of Lanes	Traffic Volume (vpd)	Speed Mean Cars (mph)	Speed Mean Trucks (mph)	Speed Mean RVs (mph)	Speed Mean All (mph)	Percent Following (%)	Platoon Size	Number of Passes
285	2412+01.271	1	159	56.5	51.9	0.0	55.8	40	2.9	0.0
286	2415+83.229	1	159	58.8	54.3	0.0	58.1	40	2.9	0.0
287	2419+65.186	1	159	59.5	56.0	0.0	59.0	40	2.8	2.0
288	2423+47.143	1	159	59.8	57.1	0.0	59.3	39	2.8	3.0
289	2427+29.101	1	160	59.9	57.9	0.0	59.6	40	2.9	3.0
290	2431+11.058	1	160	59.9	58.3	0.0	59.7	40	2.9	4.0
291	2434+93.015	1	160	59.9	58.4	0.0	59.7	41	3.0	2.0
292	2438+74.972	1	160	59.6	58.1	0.0	59.4	39	2.9	0.0
293	2442+56.930	1	160	54.7	52.8	0.0	54.4	39	2.9	0.0
294	2446+38.887	1	160	53.7	51.6	0.0	53.4	38	2.8	0.0
295	2450+20.844	1	160	55.6	52.2	0.0	55.0	38	2.8	0.0
296	2454+02.801	1	160	58.4	54.4	0.0	57.8	39	2.8	0.0
297	2457+84.759	1	160	58.6	55.8	0.0	58.2	40	2.9	0.0
298	2461+66.716	1	160	58.8	56.6	0.0	58.5	39	2.9	0.0
299	2465+48.673	1	160	59.1	57.3	0.0	58.8	39	2.9	0.0
300	2469+30.631	1	160	60.4	58.0	0.0	60.0	38	2.9	0.0

Table 6 below reports spot traffic operational data collected by the simulation at each data collection station for travel in direction of decreasing stations. These data are analogous to data that would be collected by a traffic data recorder placed at the specified location on the highway during the simulation time. The data include hourly traffic volume; measured mean speed of cars, trucks, and recreational vehicles; mean and standard deviation speed for all vehicles combined; percent of vehicles following at a headway of less than 4 seconds; the average platoon size; and number of passes. A separate table is produced for each direction of travel. The data in this station summary data tables are used to create graphs.

**Table 6. Station Summary (Decreasing)**

Station Number	Station	Number of Lanes	Traffic Volume (vpd)	Speed Mean Cars (mph)	Speed Mean Trucks (mph)	Speed Mean RVs (mph)	Speed Mean All (mph)	Percent Following (%)	Platoon Size	Number of Passes
1	2469+30.631	1	91	61.9	61.1	0.0	61.8	29	2.9	0.0
2	2465+48.673	1	91	62.3	60.1	0.0	61.9	29	2.9	0.0
3	2461+66.716	1	90	61.7	60.2	0.0	61.5	28	2.8	0.0
4	2457+84.759	1	88	61.2	60.1	0.0	61.0	27	2.9	0.0
5	2454+02.801	1	88	61.2	59.7	0.0	60.9	27	2.9	0.0
6	2450+20.844	1	88	60.4	58.4	0.0	60.1	27	2.9	1.0
7	2446+38.887	1	87	56.5	54.2	0.0	56.1	29	2.8	3.0
8	2442+56.930	1	89	56.5	53.5	0.0	56.0	29	2.7	1.0
9	2438+74.972	1	90	60.1	55.2	0.0	59.3	30	2.9	1.0
10	2434+93.015	1	90	61.4	57.1	0.0	60.8	31	2.9	2.0
11	2431+11.058	1	91	61.6	58.2	0.0	61.1	31	2.8	0.0
12	2427+29.101	1	91	61.5	58.8	0.0	61.1	31	2.6	1.0
13	2423+47.143	1	90	61.4	58.9	0.0	61.0	31	2.6	2.0
14	2419+65.186	1	90	61.2	58.8	0.0	60.9	32	2.7	0.0
15	2415+83.229	1	90	61.2	59.0	0.0	60.9	31	2.6	0.0
16	2412+01.271	1	90	61.3	59.3	0.0	61.0	31	2.6	1.0

Station Number	Station	Number of Lanes	Traffic Volume (vpd)	Speed Mean Cars (mph)	Speed Mean Trucks (mph)	Speed Mean RVs (mph)	Speed Mean All (mph)	Percent Following (%)	Platoon Size	Number of Passes
17	2408+19.314	1	90	55.4	52.0	0.0	55.0	32	2.7	3.0
18	2404+37.357	1	90	54.3	51.4	0.0	53.9	28	2.7	0.0
19	2400+55.400	1	90	54.2	51.1	0.0	53.8	23	2.8	1.0
20	2396+73.442	1	90	56.2	52.3	0.0	55.6	22	2.7	3.0
21	2392+91.485	1	90	55.7	52.7	0.0	55.2	23	2.6	1.0
22	2389+09.528	1	90	53.7	51.1	0.0	53.3	22	2.5	0.0
23	2385+27.570	1	90	53.6	51.3	0.0	53.3	22	2.5	0.0
24	2381+45.613	1	90	53.8	51.3	0.0	53.5	22	2.5	1.0
25	2377+63.656	1	90	59.1	55.6	0.0	58.6	21	2.6	0.0
26	2373+81.699	1	90	56.3	53.5	0.0	55.8	21	2.6	0.0
27	2369+99.741	1	90	56.0	53.7	0.0	55.7	21	2.6	1.0
28	2366+17.784	1	90	60.5	56.4	0.0	59.9	21	2.6	1.0
29	2362+35.827	1	90	61.6	58.3	0.0	61.2	22	2.5	0.0
30	2358+53.869	1	90	61.8	59.3	0.0	61.4	22	2.5	0.0
31	2354+71.912	1	90	61.6	59.6	0.0	61.4	22	2.5	1.0
32	2350+89.955	1	90	61.4	59.7	0.0	61.2	22	2.5	2.0
33	2347+07.998	1	90	61.4	59.9	0.0	61.2	23	2.5	0.0
34	2343+26.040	1	90	61.4	59.9	0.0	61.2	23	2.5	0.0
35	2339+44.083	1	90	61.4	60.0	0.0	61.2	22	2.5	0.0
36	2335+62.126	1	90	61.4	60.1	0.0	61.2	20	2.4	1.0
37	2331+80.169	1	90	61.4	60.1	0.0	61.2	19	2.4	0.0
38	2327+98.211	1	90	61.4	59.5	0.0	61.1	19	2.4	0.0
39	2324+16.254	1	90	61.3	59.3	0.0	61.0	19	2.4	1.0
40	2320+34.297	1	90	61.0	59.0	0.0	60.8	18	2.5	0.0
41	2316+52.339	1	91	56.9	54.5	0.0	56.5	18	2.5	0.0
42	2312+70.382	1	90	56.5	54.4	0.0	56.3	18	2.5	0.0
43	2308+88.425	1	90	56.5	54.1	0.0	56.2	19	2.5	0.0
44	2305+06.468	1	90	58.6	55.3	0.0	58.2	19	2.5	0.0
45	2301+24.510	1	90	60.9	57.8	0.0	60.5	20	2.6	0.0
46	2297+42.553	1	90	60.8	58.9	0.0	60.5	20	2.6	0.0
47	2293+60.596	1	91	60.8	59.5	0.0	60.6	20	2.6	0.0
48	2289+78.638	1	91	61.0	59.5	0.0	60.8	20	2.6	0.0
49	2285+96.681	1	91	60.9	59.5	0.0	60.7	19	2.7	0.0
50	2282+14.724	1	91	61.0	59.3	0.0	60.7	16	2.5	0.0
51	2278+32.767	1	91	56.7	54.6	0.0	56.5	18	2.6	2.0
52	2274+50.809	1	91	56.5	54.3	0.0	56.2	16	2.7	0.0
53	2270+68.852	1	91	56.3	54.1	0.0	56.0	16	2.7	0.0
54	2266+86.895	1	91	56.2	53.9	0.0	55.9	15	2.8	1.0
55	2263+04.938	1	91	56.3	53.9	0.0	56.0	15	2.6	0.0
56	2259+22.980	1	91	56.3	53.0	0.0	55.8	15	2.6	0.0
57	2255+41.023	1	90	58.7	52.8	0.0	58.0	13	2.3	1.0
58	2251+59.066	1	90	60.5	53.0	0.0	59.5	14	2.3	0.0
59	2247+77.108	1	90	56.7	52.6	0.0	56.1	14	2.1	0.0
60	2243+95.151	1	90	56.7	53.1	0.0	56.3	19	2.2	1.0
61	2240+13.194	1	90	56.8	53.5	0.0	56.4	21	2.4	1.0
62	2236+31.237	1	90	57.0	53.9	0.0	56.6	21	2.4	1.0
63	2232+49.279	1	90	59.7	56.3	0.0	59.3	20	2.3	1.0
64	2228+67.322	1	90	61.4	59.3	0.0	61.1	21	2.3	0.0
65	2224+85.365	1	90	61.6	59.9	0.0	61.4	20	2.2	0.0
66	2221+03.407	1	90	61.9	60.1	0.0	61.7	20	2.2	1.0

Station Number	Station	Number of Lanes	Traffic Volume (vpd)	Speed Mean Cars (mph)	Speed Mean Trucks (mph)	Speed Mean RVs (mph)	Speed Mean All (mph)	Percent Following (%)	Platoon Size	Number of Passes
67	2217+21.450	1	90	61.9	60.3	0.0	61.6	20	2.2	0.0
68	2213+39.493	1	90	61.8	59.9	0.0	61.5	20	2.2	3.0
69	2209+57.536	1	90	61.6	59.5	0.0	61.3	20	2.2	0.0
70	2205+75.578	1	90	61.4	59.3	0.0	61.0	20	2.2	0.0
71	2201+93.621	1	90	61.4	59.4	0.0	61.2	19	2.2	0.0
72	2198+11.664	2	90	61.4	59.3	0.0	61.4	7	2.0	0.0
73	2194+29.706	2	89	62.0	59.3	0.0	61.4	6	2.0	0.0
74	2190+47.749	2	89	57.3	55.2	0.0	57.3	2	3.0	1.0
75	2186+65.792	2	89	57.3	55.2	0.0	57.3	3	2.0	4.0
76	2182+83.835	2	89	58.0	55.2	0.0	58.0	4	2.3	3.0
77	2179+01.877	2	89	62.0	57.3	0.0	61.4	8	2.2	0.0
78	2175+19.920	2	89	62.0	57.3	0.0	61.4	12	2.2	1.0
79	2171+37.963	2	89	61.4	56.6	0.0	60.7	11	2.4	0.0
80	2167+56.006	2	89	61.4	55.9	0.0	60.7	10	2.3	1.0
81	2163+74.048	2	90	62.0	57.3	0.0	61.4	10	2.3	3.0
82	2159+92.091	2	92	62.0	58.6	0.0	61.4	9	2.1	1.0
83	2156+10.134	2	93	61.4	59.3	0.0	61.4	6	2.2	1.0
84	2152+28.176	2	93	61.4	59.3	0.0	61.4	6	2.0	1.0
85	2148+46.219	2	93	61.4	59.3	0.0	61.4	8	2.0	2.0
86	2144+64.262	2	93	61.4	59.3	0.0	61.4	9	2.1	2.0
87	2140+82.305	2	93	61.4	59.3	0.0	61.4	10	2.0	1.0
88	2137+00.347	2	93	61.4	58.6	0.0	61.4	10	2.0	1.0
89	2133+18.390	2	93	61.4	58.6	0.0	61.4	11	2.3	0.0
90	2129+36.433	2	93	61.4	58.0	0.0	61.4	10	2.3	1.0
91	2125+54.475	2	93	61.4	58.0	0.0	60.7	14	2.4	2.0
92	2121+72.518	2	92	61.4	58.6	0.0	61.4	16	2.4	0.0
93	2117+90.561	1	92	61.8	59.6	0.0	61.5	15	2.6	0.0
94	2114+08.604	1	92	61.7	59.8	0.0	61.4	15	2.6	0.0
95	2110+26.646	1	92	61.6	59.8	0.0	61.4	14	2.4	0.0
96	2106+44.689	1	91	61.5	59.3	0.0	61.2	13	2.5	0.0
97	2102+62.732	1	90	61.5	59.5	0.0	61.2	14	2.4	0.0
98	2098+80.774	1	90	61.5	59.7	0.0	61.3	16	2.4	0.0
99	2094+98.817	1	90	61.5	59.9	0.0	61.3	14	2.3	0.0
100	2091+16.860	1	91	61.5	59.9	0.0	61.3	13	2.3	0.0
101	2087+34.903	1	91	61.6	59.9	0.0	61.4	13	2.3	0.0
102	2083+52.945	1	91	61.8	59.9	0.0	61.5	14	2.3	1.0
103	2079+70.988	1	91	61.6	59.9	0.0	61.4	16	2.4	0.0
104	2075+89.031	1	91	61.5	59.7	0.0	61.3	16	2.4	0.0
105	2072+07.074	1	91	61.4	58.8	0.0	61.1	16	2.4	0.0
106	2068+25.116	1	91	61.4	58.4	0.0	61.0	15	2.4	0.0
107	2064+43.159	1	91	61.4	58.2	0.0	60.9	16	2.4	0.0
108	2060+61.202	1	91	61.4	58.5	0.0	61.0	16	2.4	0.0
109	2056+79.244	1	91	61.4	58.6	0.0	61.0	16	2.4	1.0
110	2052+97.287	1	91	61.5	58.7	0.0	61.1	18	2.5	0.0
111	2049+15.330	1	91	61.4	58.7	0.0	61.0	18	2.5	0.0
112	2045+33.373	1	91	61.4	58.6	0.0	61.0	18	2.5	0.0
113	2041+51.415	1	91	61.4	58.8	0.0	61.0	19	2.4	0.0
114	2037+69.458	1	91	61.3	58.8	0.0	61.0	19	2.4	0.0
115	2033+87.501	1	91	61.4	58.7	0.0	61.1	18	2.5	0.0
116	2030+05.543	1	91	61.4	58.7	0.0	61.1	19	2.4	1.0

Station Number	Station	Number of Lanes	Traffic Volume (vpd)	Speed Mean Cars (mph)	Speed Mean Trucks (mph)	Speed Mean RVs (mph)	Speed Mean All (mph)	Percent Following (%)	Platoon Size	Number of Passes
117	2026+23.586	1	91	61.3	58.2	0.0	60.9	19	2.3	0.0
118	2022+41.629	1	91	61.1	56.3	0.0	60.4	19	2.3	1.0
119	2018+59.672	1	91	60.6	53.7	0.0	59.7	18	2.2	0.0
120	2014+77.714	1	91	60.3	51.2	0.0	59.0	18	2.2	0.0
121	2010+95.757	1	91	60.0	49.0	0.0	58.4	15	2.3	0.0
122	2007+13.800	1	91	60.5	47.5	0.0	58.6	13	2.3	0.0
123	2003+31.842	1	93	61.0	47.9	0.0	59.2	15	2.3	0.0
124	1999+49.885	1	93	61.2	49.6	0.0	59.5	15	2.3	0.0
125	1995+67.928	1	93	61.0	52.2	0.0	59.8	15	2.3	0.0
126	1991+85.971	1	93	61.0	55.3	0.0	60.1	15	2.3	0.0
127	1988+04.013	1	93	60.8	58.2	0.0	60.5	15	2.3	0.0
128	1984+22.056	1	93	61.4	59.5	0.0	61.2	15	2.3	0.0
129	1980+40.099	2	93	61.4	59.3	0.0	61.4	5	2.0	0.0
130	1976+58.142	2	93	62.0	59.3	0.0	61.4	6	2.0	2.0
131	1972+76.184	2	93	61.4	59.3	0.0	61.4	6	2.2	3.0
132	1968+94.227	2	93	62.0	59.3	0.0	61.4	6	2.2	1.0
133	1965+12.270	2	93	62.0	59.3	0.0	61.4	10	2.1	2.0
134	1961+30.312	2	93	62.0	59.3	0.0	61.4	12	2.1	2.0
135	1957+48.355	2	93	62.0	59.3	0.0	61.4	9	2.0	0.0
136	1953+66.398	2	93	62.0	59.3	0.0	61.4	9	2.0	0.0
137	1949+84.441	2	93	62.0	59.3	0.0	61.4	8	2.0	1.0
138	1946+02.483	2	93	62.0	59.3	0.0	61.4	9	2.0	0.0
139	1942+20.526	2	93	62.0	59.3	0.0	61.4	8	2.0	0.0
140	1938+38.569	2	93	62.0	59.3	0.0	61.4	8	2.2	2.0
141	1934+56.611	2	93	62.0	59.3	0.0	61.4	8	2.2	0.0
142	1930+74.654	2	93	62.0	59.3	0.0	61.4	5	2.3	0.0
143	1926+92.697	2	93	62.0	59.3	0.0	61.4	5	2.3	2.0
144	1923+10.740	2	93	62.0	59.3	0.0	61.4	6	2.2	2.0
145	1919+28.782	2	93	62.0	59.3	0.0	61.4	5	2.0	2.0
146	1915+46.825	2	92	62.0	59.3	0.0	61.4	6	2.2	1.0
147	1911+64.868	2	92	62.0	59.3	0.0	61.4	8	2.2	0.0
148	1907+82.910	2	91	61.4	59.3	0.0	61.4	8	2.2	0.0
149	1904+00.953	2	91	56.6	53.9	0.0	56.6	4	2.3	2.0
150	1900+18.996	2	90	56.6	53.9	0.0	55.9	6	2.7	0.0
151	1896+37.039	2	90	56.6	53.2	0.0	55.9	4	2.0	1.0
152	1892+55.081	2	90	58.6	52.5	0.0	57.3	6	2.0	1.0
153	1888+73.124	2	90	56.6	50.5	0.0	55.9	9	2.1	1.0
154	1884+91.167	2	90	56.6	49.1	0.0	55.2	10	2.1	1.0
155	1881+09.210	1	90	60.4	48.9	0.0	58.8	10	2.0	0.0
156	1877+27.252	1	90	60.8	48.1	0.0	59.0	9	2.0	0.0
157	1873+45.295	1	91	60.8	47.6	0.0	58.9	8	2.0	0.0
158	1869+63.338	1	91	60.7	47.0	0.0	58.7	8	2.0	1.0
159	1865+81.380	1	91	60.5	46.6	0.0	58.6	10	2.1	0.0
160	1861+99.423	1	91	60.5	46.2	0.0	58.4	9	2.1	0.0
161	1858+17.466	1	91	58.4	45.7	0.0	56.7	11	2.1	0.0
162	1854+35.509	1	90	55.9	44.8	0.0	54.3	13	2.1	0.0
163	1850+53.551	1	90	57.0	44.6	0.0	55.2	13	2.1	1.0
164	1846+71.594	1	90	55.7	44.4	0.0	54.1	11	2.3	1.0
165	1842+89.637	1	90	55.8	44.3	0.0	54.1	11	2.3	0.0
166	1839+07.679	1	90	55.9	44.1	0.0	54.2	13	2.2	1.0

Station Number	Station	Number of Lanes	Traffic Volume (vpd)	Speed Mean Cars (mph)	Speed Mean Trucks (mph)	Speed Mean RVs (mph)	Speed Mean All (mph)	Percent Following (%)	Platoon Size	Number of Passes
167	1835+25.722	1	90	58.4	44.2	0.0	56.4	13	2.0	0.0
168	1831+43.765	1	89	60.3	45.0	0.0	58.2	14	2.0	2.0
169	1827+61.808	1	89	60.6	45.1	0.0	58.6	12	2.0	1.0
170	1823+79.850	1	89	60.8	45.3	0.0	58.6	12	2.0	0.0
171	1819+97.893	1	89	60.7	45.3	0.0	58.6	15	2.3	2.0
172	1816+15.936	1	89	60.6	45.4	0.0	58.6	15	2.3	0.0
173	1812+33.979	1	89	60.6	45.4	0.0	58.6	16	2.4	0.0
174	1808+52.021	1	90	60.6	45.5	0.0	58.6	16	2.4	0.0
175	1804+70.064	1	89	56.5	44.5	0.0	54.9	16	2.2	1.0
176	1800+88.107	1	89	56.5	44.5	0.0	55.0	17	2.1	1.0
177	1797+06.149	1	89	56.5	44.5	0.0	54.9	17	2.1	3.0
178	1793+24.192	1	89	60.5	44.8	0.0	58.4	17	2.1	1.0
179	1789+42.235	1	89	60.8	44.9	0.0	58.7	17	2.1	1.0
180	1785+60.278	1	89	61.2	46.2	0.0	59.1	16	2.2	0.0
181	1781+78.320	1	89	57.3	47.4	0.0	55.9	16	2.2	0.0
182	1777+96.363	1	89	61.4	50.5	0.0	59.9	15	2.2	0.0
183	1774+14.406	1	89	61.7	52.9	0.0	60.5	15	2.2	0.0
184	1770+32.448	2	88	62.0	53.2	0.0	60.7	3	2.0	0.0
185	1766+50.491	2	88	61.4	52.5	0.0	60.7	3	2.0	0.0
186	1762+68.534	2	88	61.4	49.8	0.0	59.3	3	2.0	1.0
187	1758+86.577	2	87	60.7	47.7	0.0	59.3	2	2.0	2.0
188	1755+04.619	2	86	61.4	47.7	0.0	59.3	2	2.0	2.0
189	1751+22.662	2	87	61.4	49.8	0.0	60.0	6	2.3	1.0
190	1747+40.705	2	87	62.0	51.8	0.0	60.7	6	2.3	2.0
191	1743+58.747	2	87	62.0	54.5	0.0	60.7	8	2.2	1.0
192	1739+76.790	2	87	62.0	57.3	0.0	61.4	10	2.1	0.0
193	1735+94.833	2	87	62.0	58.6	0.0	61.4	10	2.1	0.0
194	1732+12.876	2	86	58.0	53.9	0.0	57.3	8	2.0	0.0
195	1728+30.918	2	86	57.3	53.2	0.0	56.6	6	2.0	0.0
196	1724+48.961	2	86	59.3	51.1	0.0	58.0	6	2.0	0.0
197	1720+67.004	2	87	56.6	49.1	0.0	55.9	6	2.0	1.0
198	1716+85.047	2	87	56.6	47.0	0.0	55.2	2	2.0	0.0
199	1713+03.089	2	87	58.6	46.4	0.0	56.6	2	2.0	1.0
200	1709+21.132	2	87	60.7	47.0	0.0	58.6	5	2.0	0.0
201	1705+39.175	2	87	61.4	48.4	0.0	59.3	5	2.0	1.0
202	1701+57.217	2	87	61.4	49.8	0.0	60.0	5	2.0	0.0
203	1697+75.260	2	87	61.4	50.5	0.0	60.0	3	2.0	0.0
204	1693+93.303	2	88	57.3	49.8	0.0	55.9	2	2.0	1.0
205	1690+11.346	2	90	57.3	50.5	0.0	55.9	2	2.0	0.0
206	1686+29.388	2	90	61.4	53.2	0.0	60.0	2	2.0	0.0
207	1682+47.431	2	91	60.7	54.5	0.0	59.3	7	2.0	2.0
208	1678+65.474	2	91	56.6	52.5	0.0	55.9	9	2.1	1.0
209	1674+83.516	1	91	56.9	53.5	0.0	56.4	9	2.1	0.0
210	1671+01.559	1	91	61.3	56.9	0.0	60.6	9	2.1	0.0
211	1667+19.602	1	91	57.6	55.0	0.0	57.2	7	2.0	0.0
212	1663+37.645	1	91	57.8	54.6	0.0	57.3	8	2.0	1.0
213	1659+55.687	1	91	57.8	54.1	0.0	57.3	8	2.0	0.0
214	1655+73.730	1	91	61.7	56.9	0.0	61.0	7	2.0	0.0
215	1651+91.773	1	91	62.2	58.7	0.0	61.6	7	2.0	1.0
216	1648+09.815	1	91	62.2	58.7	0.0	61.6	7	2.0	0.0



Station Number	Station	Number of Lanes	Traffic Volume (vpd)	Speed Mean Cars (mph)	Speed Mean Trucks (mph)	Speed Mean RVs (mph)	Speed Mean All (mph)	Percent Following (%)	Platoon Size	Number of Passes
217	1644+27.858	1	91	58.1	54.0	0.0	57.5	8	2.0	1.0
218	1640+45.901	1	91	58.2	54.4	0.0	57.6	7	2.0	2.0
219	1636+63.944	1	91	58.2	54.7	0.0	57.7	8	2.0	2.0
220	1632+81.986	1	91	58.1	54.6	0.0	57.5	9	2.0	0.0
221	1629+00.029	1	90	58.0	54.5	0.0	57.5	6	2.0	0.0
222	1625+18.072	1	89	61.5	57.6	0.0	60.9	6	2.0	0.0
223	1621+36.115	1	89	62.3	58.9	0.0	61.8	6	2.0	0.0
224	1617+54.157	1	89	59.9	55.6	0.0	59.3	6	2.0	0.0
225	1613+72.200	1	89	57.7	53.3	0.0	57.1	7	2.0	0.0
226	1609+90.243	1	89	57.8	53.3	0.0	57.1	8	2.0	0.0
227	1606+08.285	1	89	61.9	54.1	0.0	60.7	8	2.0	0.0
228	1602+26.328	1	89	61.6	52.4	0.0	60.2	8	2.0	0.0
229	1598+44.371	2	89	60.0	49.1	0.0	58.0	4	2.0	0.0
230	1594+62.414	2	89	59.3	46.4	0.0	57.3	4	2.0	0.0
231	1590+80.456	2	89	59.3	43.6	0.0	56.6	3	2.0	1.0
232	1586+98.499	2	90	58.6	41.6	0.0	55.9	6	2.0	3.0
233	1583+16.542	2	90	58.6	40.2	0.0	55.9	9	2.0	1.0
234	1579+34.584	2	90	58.6	38.9	0.0	55.2	9	2.0	2.0
235	1575+52.627	2	90	58.0	38.2	0.0	55.2	8	2.0	1.0
236	1571+70.670	2	89	58.6	37.5	0.0	55.2	8	2.0	1.0
237	1567+88.713	2	89	58.6	38.2	0.0	55.2	9	2.0	2.0
238	1564+06.755	2	89	59.3	40.2	0.0	56.6	8	2.0	2.0
239	1560+24.798	2	90	60.0	43.6	0.0	57.3	3	2.0	0.0
240	1556+42.841	2	90	60.7	47.0	0.0	58.6	2	2.0	1.0
241	1552+60.883	2	90	60.7	50.5	0.0	59.3	4	2.0	2.0
242	1548+78.926	2	90	60.7	52.5	0.0	59.3	12	2.1	0.0
243	1544+96.969	1	90	61.8	55.2	0.0	60.8	16	2.2	0.0
244	1541+15.012	1	90	61.8	56.9	0.0	61.0	16	2.2	0.0
245	1537+33.054	1	90	58.9	55.1	0.0	58.3	14	2.2	1.0
246	1533+51.097	1	90	57.4	53.5	0.0	56.8	14	2.2	1.0
247	1529+69.140	1	90	57.4	53.9	0.0	56.9	13	2.2	2.0
248	1525+87.183	1	91	57.1	54.1	0.0	56.7	13	2.2	1.0
249	1522+05.225	1	91	57.0	54.4	0.0	56.6	11	2.3	0.0
250	1518+23.268	1	91	60.3	55.4	0.0	59.5	12	2.2	1.0
251	1514+41.311	1	91	61.6	55.1	0.0	60.5	12	2.2	0.0
252	1510+59.353	1	91	61.1	52.6	0.0	59.8	10	2.0	1.0
253	1506+77.396	1	91	60.5	49.2	0.0	58.8	11	2.1	1.0
254	1502+95.439	1	91	61.0	47.6	0.0	59.0	11	2.1	0.0
255	1499+13.482	1	91	62.0	47.9	0.0	59.9	11	2.1	1.0
256	1495+31.524	1	91	59.7	49.2	0.0	58.1	10	2.1	0.0
257	1491+49.567	1	93	57.8	50.9	0.0	56.7	10	2.0	2.0
258	1487+67.610	1	93	57.5	53.4	0.0	56.9	9	2.0	1.0
259	1483+85.652	1	93	57.3	54.4	0.0	56.9	9	2.0	0.0
260	1480+03.695	1	93	61.0	58.6	0.0	60.7	11	2.0	0.0
261	1476+21.738	1	93	62.0	60.2	0.0	61.8	10	2.0	0.0
262	1472+39.781	1	93	62.0	60.2	0.0	61.8	10	2.0	1.0
263	1468+57.823	1	93	62.1	59.8	0.0	61.8	12	2.0	0.0
264	1464+75.866	1	93	61.8	58.2	0.0	61.3	13	2.1	1.0
265	1460+93.909	1	93	61.5	56.5	0.0	60.8	14	2.1	1.0
266	1457+11.952	1	93	61.3	55.2	0.0	60.3	15	2.2	0.0

Station Number	Station	Number of Lanes	Traffic Volume (vpd)	Speed Mean Cars (mph)	Speed Mean Trucks (mph)	Speed Mean RVs (mph)	Speed Mean All (mph)	Percent Following (%)	Platoon Size	Number of Passes
267	1453+29.994	1	93	61.6	54.3	0.0	60.5	15	2.2	0.0
268	1449+48.037	1	93	61.9	54.9	0.0	60.9	15	2.2	1.0
269	1445+66.080	1	94	62.0	55.6	0.0	61.0	14	2.1	2.0
270	1441+84.122	1	93	61.8	57.7	0.0	61.2	14	2.2	0.0
271	1438+02.165	1	93	56.9	54.1	0.0	56.4	14	2.2	0.0
272	1434+20.208	1	93	56.8	54.1	0.0	56.3	10	2.0	1.0
273	1430+38.251	1	93	56.7	54.1	0.0	56.3	10	2.0	0.0
274	1426+56.293	1	93	60.3	54.8	0.0	59.4	10	2.0	1.0
275	1422+74.336	1	93	60.5	54.2	0.0	59.5	10	2.0	0.0
276	1418+92.379	1	93	56.4	52.7	0.0	55.8	9	2.0	0.0
277	1415+10.421	1	93	56.5	52.9	0.0	55.9	10	2.0	0.0
278	1411+28.464	1	93	56.7	53.5	0.0	56.2	10	2.0	0.0
279	1407+46.507	1	93	59.4	55.6	0.0	58.8	11	2.1	1.0
280	1403+64.550	1	93	61.7	58.9	0.0	61.2	11	2.1	1.0
281	1399+82.592	1	93	61.8	59.4	0.0	61.4	11	2.1	0.0
282	1396+00.635	1	93	61.8	58.9	0.0	61.3	11	2.1	0.0
283	1392+18.678	1	93	61.8	58.2	0.0	61.2	10	2.1	1.0
284	1388+36.720	1	93	61.8	59.2	0.0	61.4	10	2.1	0.0
285	1384+54.763	1	93	61.8	59.6	0.0	61.4	11	2.1	0.0
286	1380+72.806	1	93	61.7	59.7	0.0	61.4	10	2.1	0.0
287	1376+90.849	1	93	61.8	59.7	0.0	61.4	11	2.1	0.0
288	1373+08.891	1	93	57.6	54.5	0.0	57.1	10	2.1	1.0
289	1369+26.934	1	93	57.5	54.3	0.0	57.0	10	2.1	0.0
290	1365+44.977	1	94	57.4	54.3	0.0	56.9	10	2.1	0.0
291	1361+63.020	1	94	57.3	54.3	0.0	56.9	8	2.1	0.0
292	1357+81.062	1	94	60.3	55.8	0.0	59.5	12	2.1	0.0
293	1353+99.105	1	95	56.0	52.8	0.0	55.5	12	2.1	0.0
294	1350+17.148	1	95	56.5	52.8	0.0	55.8	13	2.1	1.0
295	1346+35.190	1	95	59.4	54.8	0.0	58.6	13	2.1	0.0
296	1342+53.233	1	95	57.1	53.9	0.0	56.6	14	2.1	0.0
297	1338+71.276	1	94	56.9	53.7	0.0	56.4	14	2.1	0.0
298	1334+89.319	1	94	59.2	54.9	0.0	58.5	15	2.1	0.0
299	1331+07.361	1	94	61.3	57.1	0.0	60.6	15	2.1	0.0
300	1327+25.404	1	94	61.5	58.4	0.0	61.0	15	2.1	0.0

*Interactive Highway Safety Design Model*

**Traffic Analysis Evaluation Report**

**P2 Alignment Alternative**

January 4, 2018



## **Disclaimer**

The Interactive Highway Design Model (IHSDM) software is disseminated under the sponsorship of the Department of Transportation in the interest of information exchange. The United States Government assumes no liability for its content or use thereof. This document does not constitute a standard, specification, or regulation.

The United States Government does not endorse products or manufacturers. Trade and manufacturers' names may appear in this software and documentation only because they are considered essential to the objective of the software.

## **Limited Warranty and Limitations of Remedies**

This software product is provided "as-is," without warranty of any kind-either expressed or implied (but not limited to the implied warranties of merchantability and fitness for a particular purpose). The FHWA do not warrant that the functions contained in the software will meet the end-user's requirements or that the operation of the software will be uninterrupted and error-free.

Under no circumstances will the FHWA be liable to the end-user for any damages or claimed lost profits, lost savings, or other incidental or consequential damages rising out of the use or inability to use the software (even if these organizations have been advised of the possibility of such damages), or for any claim by any other party.

## **Notice**

The use of the IHSDM software is being done strictly on a voluntary basis. In exchange for provision of IHSDM, the user agrees that the Federal Highway Administration (FHWA), U.S. Department of Transportation and any other agency of the Federal Government shall not be responsible for any errors, damage or other liability that may result from any and all use of the software, including installation and testing of the software. The user further agrees to hold the FHWA and the Federal Government harmless from any resulting liability. The user agrees that this hold harmless provision shall flow to any person to whom or any entity to which the user provides the IHSDM software. It is the user's full responsibility to inform any person to whom or any entity to which it provides the IHSDM software of this hold harmless provision.

---

---

## Table of Contents

<b>Report Overview</b> .....	<b>1</b>
<b>Traffic Analysis Graphical Results</b> .....	<b>2</b>
<b>Simulation Input Data</b> .....	<b>7</b>
<b>Simulation Output Summary</b> .....	<b>9</b>
<b>Simulation Station Summaries</b> .....	<b>10</b>

## List of Tables

Table Simulation Parameters .....	7
Table Random Number Generator Seeds .....	7
Table Traffic Input Data .....	8
Table Section Summary .....	9
Table Station Summary (Increasing) .....	10
Table Station Summary (Decreasing) .....	16

## List of Figures

Figure Graphical Results (Increasing) .....	3
Figure Graphical Results (Decreasing) .....	5

## **Report Overview**

**Report Generated:** Jan 4, 2018 9:10 AM

**Report Template:** System: Multi-Page [System] (tam2, Oct 9, 2017 1:45 PM)

**Evaluation Date:** Thu Jan 04 09:09:33 AKST 2018

**IHSDM Version:** v13.0.0 (Sep 13, 2017)

**Traffic Analysis Module:** v1.6.0 (Mar 24, 2017)

**User Name:** RaeAnne Hebnes

**Organization Name:** Michael Baker International

**Phone:**

**E-Mail:**

**Project Title:** Parks 305 - 325 v2

**Project Comment:** Created using wizard

**Project Unit System:** U.S. Customary

**Highway Title:** Alignment P2\_1dec2017

**Highway Comment:** Alignment P2\_1dec2017

**Highway Version:** 1

**Evaluation Title:** Evaluation 5

**Evaluation Comment:** Created Thu Jan 04 09:09:15 AKST 2018

**Minimum Station:** 1327+09.000

**Maximum Station:** 2424+38.143

**Configuration Name:** Default



## **Traffic Analysis Graphical Results**

[[Graphical Results in the Engineer's Manual](#)]

Figure 1 below displays the graphical results of the Traffic Analysis Module evaluation for the increasing direction of travel.

Traffic Analysis Summary, Increasing Direction of Travel  
 Project: Parks 305 - 325 v2, Evaluation: Evaluation 5  
 Highway: Alignment P2\_1\_dec2017

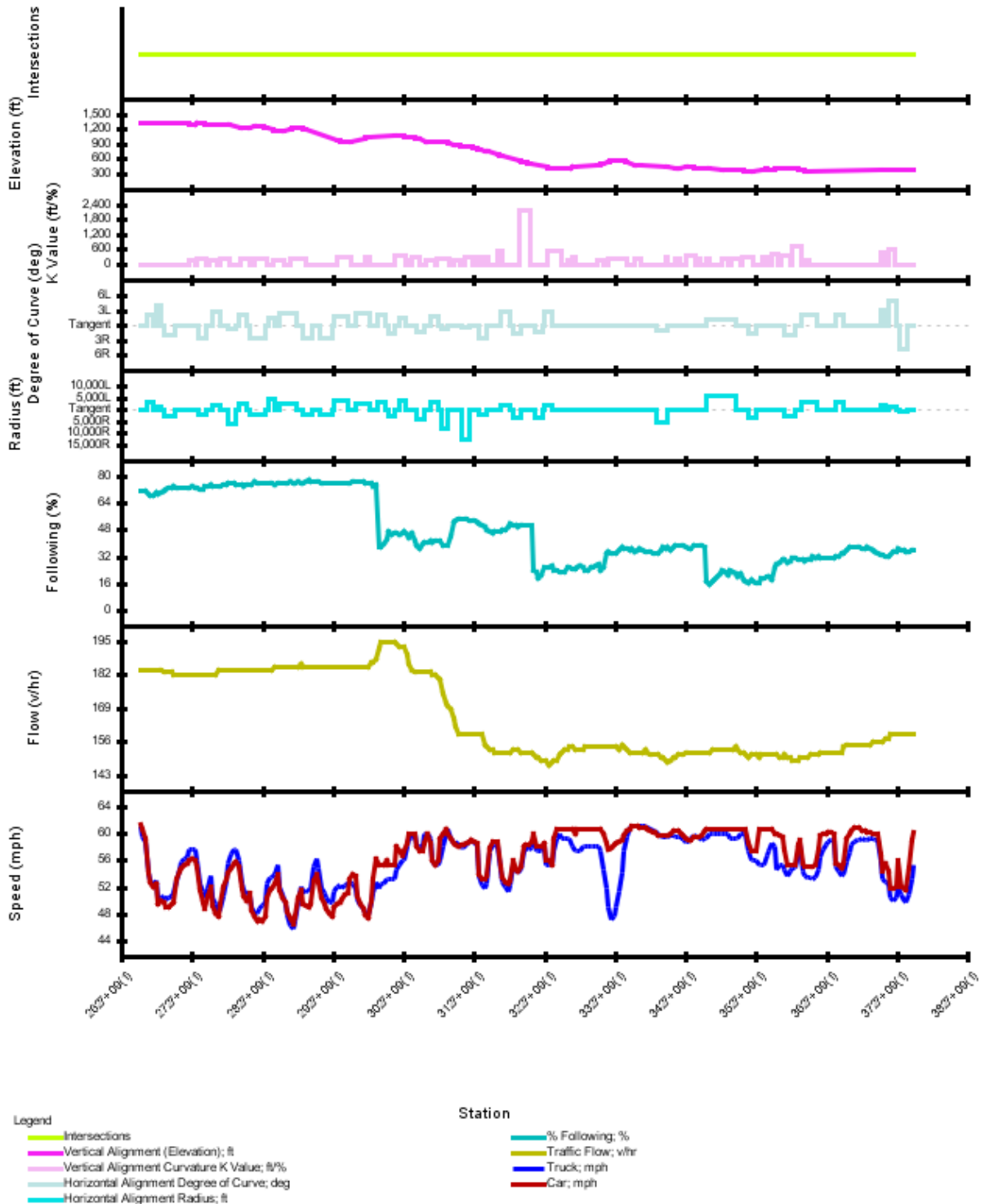

Figure 1. Graphical Results (Increasing)

Figure 2 below displays the graphical results of the Traffic Analysis Module evaluation for the decreasing direction of travel.

Traffic Analysis Summary, Decreasing Direction of Travel  
 Project: Parks 305 - 325 v2, Evaluation: Evaluation 5  
 Highway: Alignment P2\_1\_dec2017

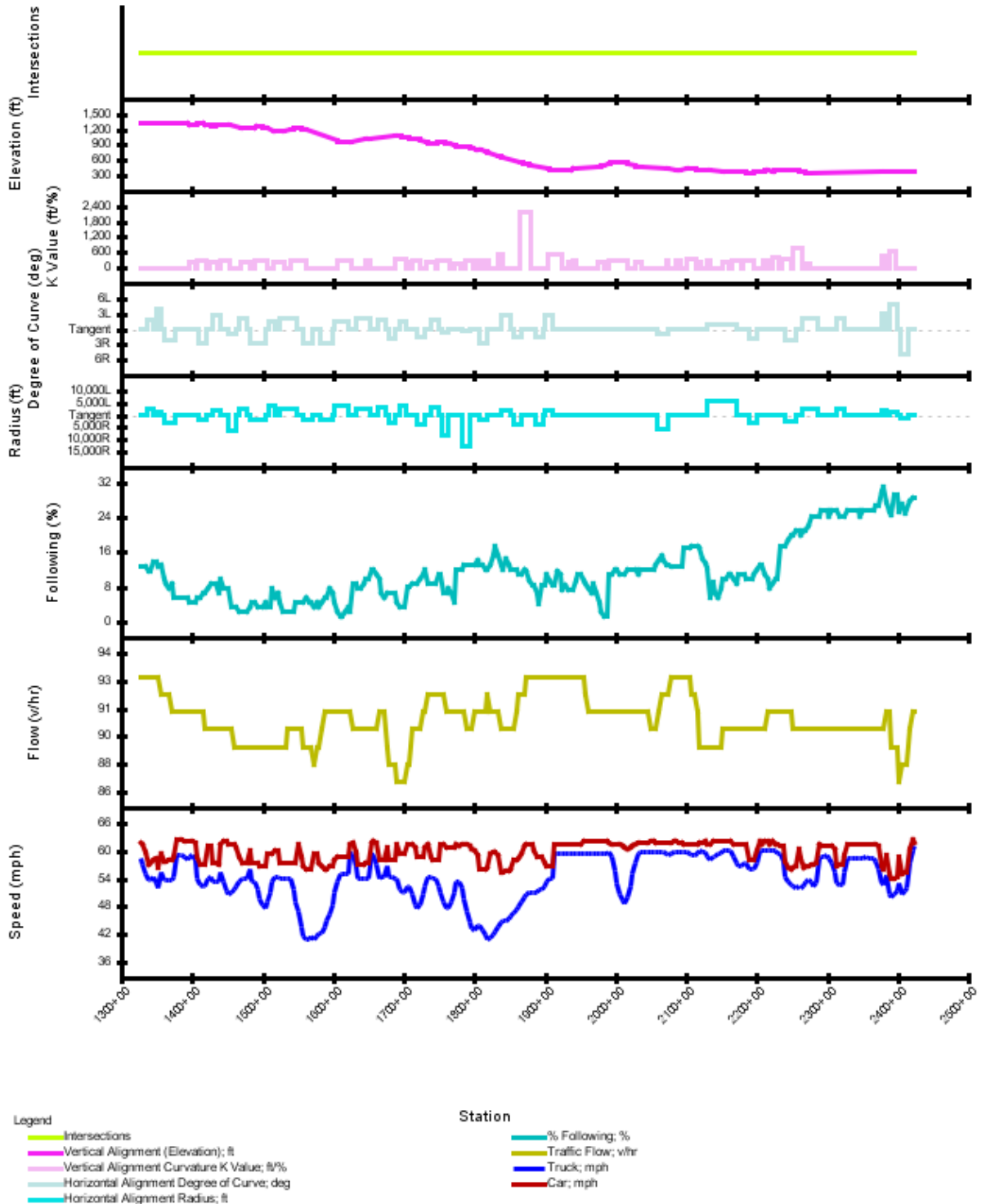

Figure 2. Graphical Results (Decreasing)



## Simulation Input Data

[Traffic Input Data in the Engineer's Manual]

**Table 1. Simulation Parameters**

Simulation Time (min)	60
Warm-up Time (min)	10
Total Time (min)	70
Computer Time (sec)	1
Test Road Length (mi)	20.7820

**Table 2. Random Number Generator Seeds**

Description	Value
Entering Traffic in Platoons / Direction of Increasing Stations	81250132
Desired Speed / Direction of Increasing Stations	70867724
Entering Traffic in Platoons / Direction of Decreasing Stations	33333334
Desired Speed / Direction of Decreasing Stations	16532240
Passing Decisions	52338126

**Table 3. Traffic Input Data**

Direction of Travel	Flow Rate (vph)	Distribution Cars (%)	Distribution Trucks (%)	Distribution RVs (%)	Mean Desired Speed Cars (mph)	Mean Desired Speed Trucks (mph)	Mean Desired Speed RVs (mph)	Desired Speed Standard Deviation Cars (mph)	Desired Speed Standard Deviation Trucks (mph)	Desired Speed Standard Deviation RVs (mph)	Entering Traffic in Platoons (%)	No Passing Zone (%)
Increasing	170	83	17	0	61.5	59.5	59.5	5.0	3.5	4.0	65	0
Decreasing	91	83	17	0	61.5	59.5	59.5	5.0	3.5	4.0	35	0



## Simulation Output Summary

[Section Summary in the Engineer's Manual]

Table 4 below includes the traffic output data table for the main road section. The table reports the actual simulated flow rate, percent time spent following, average speed, trip time, traffic delay, geometric delay, total delay, number of passes, vehicle-distance traveled, and vehicle-hours of travel. These simulation outputs are reported for each direction and both directions combined.

**Table 4. Section Summary**

Direction of Travel	Flow Rate from Simulation (vph)	Percent Time Spent Following (%)	Average Travel Speed (mph)	Trip Time (min/veh)	Traffic Delay (min/veh)	Geometric Delay (min/veh)	Total Delay (min/v eh)	Number of Passes	Distance Traveled (mi)	Total Travel Time (veh-hrs)
Increasing	167	51	55.0	22.4	1.0	0.9	1.9	495	3,443.5	62.6
Decreasing	91	12	58.2	21.4	-0.4	1.2	0.8	175	1,882.1	32.3
Combined	258	37	56.1	22.1	0.5	1.0	1.5	670	5,325.6	94.9

## Simulation Station Summaries

[Station Summary in the Engineer's Manual]

Table 5 below reports spot traffic operational data collected by the simulation at each data collection station for travel in direction of increasing stations. These data are analogous to data that would be collected by a traffic data recorder placed at the specified location on the highway during the simulation time. The data include hourly traffic volume; measured mean speed of cars, trucks, and recreational vehicles; mean and standard deviation speed for all vehicles combined; percent of vehicles following at a headway of less than 4 seconds; the average platoon size; and number of passes. A separate table is produced for each direction of travel. The data in this station summary data tables are used to create graphs.

**Table 5. Station Summary (Increasing)**

Station Number	Station	Number of Lanes	Traffic Volume (vpd)	Speed Mean Cars (mph)	Speed Mean Trucks (mph)	Speed Mean RVs (mph)	Speed Mean All (mph)	Percent Following (%)	Platoon Size	Number of Passes
1	1327+25.404	1	184	61.4	61.0	0.0	61.4	71	5.5	0.0
2	1330+92.281	1	184	60.7	59.5	0.0	60.5	71	5.5	0.0
3	1334+59.159	1	184	59.3	58.7	0.0	59.3	71	5.5	0.0
4	1338+26.036	1	184	54.2	54.2	0.0	54.2	69	4.6	0.0
5	1341+92.913	1	184	52.8	52.9	0.0	52.8	68	4.6	0.0
6	1345+59.791	1	184	52.0	52.2	0.0	52.0	68	4.6	0.0
7	1349+26.668	1	184	52.6	52.9	0.0	52.7	70	5.0	0.0
8	1352+93.546	1	184	49.4	50.2	0.0	49.5	70	4.9	0.0
9	1356+60.423	1	184	49.9	50.3	0.0	50.0	70	4.9	0.0
10	1360+27.300	1	183	49.7	50.6	0.0	49.8	71	4.9	0.0
11	1363+94.178	1	183	49.1	50.1	0.0	49.2	72	5.3	0.0
12	1367+61.055	1	183	49.1	50.3	0.0	49.3	73	5.4	0.0
13	1371+27.932	1	183	49.4	50.6	0.0	49.5	73	5.6	0.0
14	1374+94.810	1	182	49.8	51.1	0.0	50.0	74	5.6	0.0
15	1378+61.687	1	182	53.1	52.9	0.0	53.1	73	5.4	0.0
16	1382+28.565	1	182	54.3	54.6	0.0	54.3	73	5.4	0.0
17	1385+95.442	1	182	54.9	55.8	0.0	55.0	73	5.4	0.0
18	1389+62.319	1	182	55.3	56.3	0.0	55.4	73	5.4	0.0
19	1393+29.197	1	182	55.6	56.5	0.0	55.8	73	5.4	0.0
20	1396+96.074	1	182	56.0	57.5	0.0	56.2	73	5.4	0.0
21	1400+62.951	1	182	56.1	57.7	0.0	56.3	74	5.6	0.0
22	1404+29.829	1	182	56.0	57.5	0.0	56.2	73	5.4	0.0
23	1407+96.706	1	182	55.0	56.0	0.0	55.1	73	5.4	0.0
24	1411+63.584	1	182	51.5	52.6	0.0	51.6	72	5.1	0.0
25	1415+30.461	1	182	49.8	51.4	0.0	50.0	72	5.1	0.0
26	1418+97.338	1	182	48.8	50.5	0.0	49.0	74	5.5	0.0
27	1422+64.216	1	182	50.6	51.8	0.0	50.7	74	5.7	0.0
28	1426+31.093	1	182	52.1	53.7	0.0	52.3	75	5.9	0.0
29	1429+97.970	1	182	49.2	50.3	0.0	49.3	74	5.5	0.0
30	1433+64.848	1	182	48.1	49.4	0.0	48.3	74	5.5	0.0
31	1437+31.725	1	184	47.5	48.4	0.0	47.6	74	5.5	0.0
32	1440+98.603	1	184	49.4	48.8	0.0	49.2	74	5.5	0.0
33	1444+65.480	1	184	52.0	50.6	0.0	51.8	74	5.7	0.0
34	1448+32.357	1	184	53.3	53.0	0.0	53.2	75	5.9	0.0

Station Number	Station	Number of Lanes	Traffic Volume (vpd)	Speed Mean Cars (mph)	Speed Mean Trucks (mph)	Speed Mean RVs (mph)	Speed Mean All (mph)	Percent Following (%)	Platoon Size	Number of Passes
35	1451+99.235	1	184	54.2	55.4	0.0	54.3	76	6.2	0.0
36	1455+66.112	1	184	54.9	56.9	0.0	55.2	76	6.2	0.0
37	1459+32.989	1	184	55.4	57.5	0.0	55.7	76	6.0	0.0
38	1462+99.867	1	184	55.8	57.7	0.0	56.0	74	5.3	0.0
39	1466+66.744	1	184	55.0	56.0	0.0	55.1	74	5.3	0.0
40	1470+33.622	1	184	51.9	52.4	0.0	52.0	74	5.3	0.0
41	1474+00.499	1	184	50.7	51.5	0.0	50.7	74	5.3	0.0
42	1477+67.376	1	184	50.0	50.9	0.0	50.1	74	5.3	0.0
43	1481+34.254	1	184	51.2	50.7	0.0	51.1	74	5.3	0.0
44	1485+01.131	1	184	48.5	49.0	0.0	48.6	74	5.3	0.0
45	1488+68.008	1	184	47.5	48.1	0.0	47.5	77	5.5	0.0
46	1492+34.886	1	184	47.0	48.1	0.0	47.1	76	5.4	0.0
47	1496+01.763	1	184	47.1	48.7	0.0	47.3	76	5.2	0.0
48	1499+68.641	1	184	47.0	49.2	0.0	47.3	76	5.4	0.0
49	1503+35.518	1	184	47.6	49.7	0.0	47.9	76	5.2	0.0
50	1507+02.395	1	184	50.3	52.6	0.0	50.7	76	5.2	0.0
51	1510+69.273	1	184	51.5	53.5	0.0	51.8	76	5.4	0.0
52	1514+36.150	1	184	51.9	53.5	0.0	52.1	76	5.2	0.0
53	1518+03.027	1	185	52.4	54.0	0.0	52.6	75	5.2	1.0
54	1521+69.905	1	185	54.0	55.3	0.0	54.2	76	5.4	0.0
55	1525+36.782	1	185	51.5	52.0	0.0	51.6	76	5.4	0.0
56	1529+03.660	1	185	50.5	50.9	0.0	50.5	76	5.4	0.0
57	1532+70.537	1	185	49.6	49.5	0.0	49.6	76	5.4	0.0
58	1536+37.414	1	185	48.4	47.9	0.0	48.3	76	5.5	0.0
59	1540+04.292	1	185	47.3	46.3	0.0	47.1	77	5.7	0.0
60	1543+71.169	1	185	46.5	45.7	0.0	46.4	76	5.7	0.0
61	1547+38.046	1	185	47.5	46.8	0.0	47.4	76	5.7	0.0
62	1551+04.924	1	185	50.5	49.6	0.0	50.3	77	5.9	0.0
63	1554+71.801	1	186	51.6	52.1	0.0	51.7	76	5.7	0.0
64	1558+38.679	1	185	49.4	51.1	0.0	49.6	76	5.5	0.0
65	1562+05.556	1	185	49.2	51.5	0.0	49.6	77	5.7	0.0
66	1565+72.433	1	185	49.0	51.3	0.0	49.3	77	5.9	0.0
67	1569+39.311	1	185	49.5	51.6	0.0	49.8	77	5.7	0.0
68	1573+06.188	1	185	52.9	55.1	0.0	53.3	77	5.7	0.0
69	1576+73.065	1	185	53.9	56.2	0.0	54.3	77	5.7	1.0
70	1580+39.943	1	185	52.8	54.9	0.0	53.0	77	5.7	0.0
71	1584+06.820	1	185	50.5	51.7	0.0	50.6	76	5.4	0.0
72	1587+73.698	1	185	49.4	51.1	0.0	49.6	76	5.5	0.0
73	1591+40.575	1	185	48.8	50.5	0.0	49.0	76	5.5	0.0
74	1595+07.452	1	185	48.0	49.8	0.0	48.2	76	5.5	0.0
75	1598+74.330	1	185	47.7	49.8	0.0	47.9	76	5.5	0.0
76	1602+41.207	1	185	49.0	51.4	0.0	49.3	76	5.5	0.0
77	1606+08.084	1	185	49.4	52.0	0.0	49.7	76	5.4	0.0
78	1609+74.962	1	185	49.6	52.2	0.0	49.9	76	5.5	0.0
79	1613+41.839	1	185	50.1	51.9	0.0	50.3	76	5.5	0.0
80	1617+08.716	1	185	50.8	52.2	0.0	50.9	76	5.4	0.0
81	1620+75.594	1	185	51.1	52.4	0.0	51.3	76	5.4	0.0
82	1624+42.471	1	185	53.3	52.8	0.0	53.2	76	5.5	1.0
83	1628+09.349	1	185	53.9	52.4	0.0	53.7	77	5.7	1.0
84	1631+76.226	1	185	53.6	51.8	0.0	53.3	77	5.7	0.0

Station Number	Station	Number of Lanes	Traffic Volume (vpd)	Speed Mean Cars (mph)	Speed Mean Trucks (mph)	Speed Mean RVs (mph)	Speed Mean All (mph)	Percent Following (%)	Platoon Size	Number of Passes
85	1635+43.103	1	185	50.6	50.1	0.0	50.5	77	5.9	0.0
86	1639+09.981	1	185	49.4	49.2	0.0	49.4	77	5.9	0.0
87	1642+76.858	1	185	48.8	48.7	0.0	48.8	77	5.9	0.0
88	1646+43.735	1	185	47.9	48.1	0.0	47.9	76	5.7	0.0
89	1650+10.613	1	185	47.3	47.8	0.0	47.3	76	5.7	0.0
90	1653+77.490	1	187	49.9	49.6	0.0	49.8	75	5.4	0.0
91	1657+44.368	1	187	53.1	51.2	0.0	52.8	74	5.1	0.0
92	1661+11.245	1	188	56.3	52.7	0.0	55.8	74	5.2	0.0
93	1664+78.122	2	192	55.2	51.8	0.0	54.5	38	3.0	0.0
94	1668+45.000	2	195	55.2	52.5	0.0	54.5	38	3.0	5.0
95	1672+11.877	2	195	55.2	52.5	0.0	55.2	40	2.8	19.0
96	1675+78.754	2	195	55.9	53.2	0.0	55.9	43	2.7	14.0
97	1679+45.632	2	195	55.2	53.2	0.0	55.2	47	2.9	6.0
98	1683+12.509	2	195	55.2	53.2	0.0	55.2	45	2.7	8.0
99	1686+79.387	2	195	55.2	53.2	0.0	55.2	46	2.8	17.0
100	1690+46.264	2	194	58.0	54.5	0.0	57.3	46	3.0	16.0
101	1694+13.141	2	193	57.3	55.2	0.0	56.6	45	2.9	10.0
102	1697+80.019	2	193	56.6	55.9	0.0	56.6	46	3.0	12.0
103	1701+46.896	2	193	57.3	55.9	0.0	56.6	47	3.2	11.0
104	1705+13.773	2	190	58.6	58.0	0.0	58.6	45	3.0	12.0
105	1708+80.651	2	186	60.0	59.3	0.0	60.0	44	2.9	6.0
106	1712+47.528	2	184	60.0	59.3	0.0	60.0	46	3.0	5.0
107	1716+14.406	2	183	60.0	60.0	0.0	60.0	41	3.3	6.0
108	1719+81.283	2	183	58.0	58.0	0.0	58.0	38	3.2	7.0
109	1723+48.160	2	183	57.3	58.0	0.0	57.3	37	3.1	13.0
110	1727+15.038	2	183	57.3	58.0	0.0	57.3	39	3.1	8.0
111	1730+81.915	2	183	58.6	60.0	0.0	59.3	40	3.1	9.0
112	1734+48.792	2	183	60.0	60.0	0.0	60.0	40	3.2	8.0
113	1738+15.670	2	183	58.6	59.3	0.0	58.6	42	3.0	5.0
114	1741+82.547	2	182	55.9	55.9	0.0	55.9	41	3.0	8.0
115	1745+49.425	2	182	55.2	55.2	0.0	55.2	41	3.2	7.0
116	1749+16.302	2	181	55.9	55.2	0.0	55.2	41	3.3	5.0
117	1752+83.179	2	180	59.3	55.9	0.0	58.6	41	3.1	6.0
118	1756+50.057	2	175	60.0	58.0	0.0	60.0	38	3.0	7.0
119	1760+16.934	2	171	60.7	60.0	0.0	60.0	39	2.9	4.0
120	1763+83.811	2	170	60.0	60.7	0.0	60.0	39	2.9	2.0
121	1767+50.689	2	169	59.3	59.3	0.0	59.3	44	3.6	8.0
122	1771+17.566	2	165	58.6	58.6	0.0	58.6	53	4.0	8.0
123	1774+84.444	1	162	58.2	58.8	0.0	58.4	53	3.9	0.0
124	1778+51.321	1	159	58.1	58.4	0.0	58.2	55	4.1	0.0
125	1782+18.198	1	159	58.2	57.9	0.0	58.2	54	4.1	0.0
126	1785+85.076	1	159	58.4	57.8	0.0	58.3	54	4.1	0.0
127	1789+51.953	1	159	58.6	58.2	0.0	58.6	55	4.2	0.0
128	1793+18.830	1	159	58.8	58.8	0.0	58.8	54	4.0	0.0
129	1796+85.708	1	159	58.9	58.9	0.0	58.9	54	4.0	0.0
130	1800+52.585	1	159	58.8	58.6	0.0	58.8	54	4.0	0.0
131	1804+19.463	1	159	58.5	58.2	0.0	58.4	52	4.0	0.0
132	1807+86.340	1	159	54.0	53.6	0.0	53.9	52	3.9	0.0
133	1811+53.217	1	159	53.3	52.3	0.0	53.2	51	3.5	0.0
134	1815+20.095	1	155	53.2	51.8	0.0	53.0	50	3.3	0.0

Station Number	Station	Number of Lanes	Traffic Volume (vpd)	Speed Mean Cars (mph)	Speed Mean Trucks (mph)	Speed Mean RVs (mph)	Speed Mean All (mph)	Percent Following (%)	Platoon Size	Number of Passes
135	1818+86.972	1	154	53.7	52.6	0.0	53.6	48	3.5	0.0
136	1822+53.849	1	153	57.8	57.4	0.0	57.8	47	3.3	0.0
137	1826+20.727	1	153	58.7	58.2	0.0	58.6	46	3.3	0.0
138	1829+87.604	1	152	58.7	58.2	0.0	58.6	47	3.4	0.0
139	1833+54.482	1	152	58.8	58.0	0.0	58.6	47	3.4	0.0
140	1837+21.359	1	152	55.0	54.5	0.0	55.0	47	3.4	0.0
141	1840+88.236	1	152	53.5	52.8	0.0	53.4	48	3.4	0.0
142	1844+55.114	1	152	52.8	52.0	0.0	52.7	48	3.4	0.0
143	1848+21.991	1	152	52.6	51.4	0.0	52.4	50	3.4	0.0
144	1851+88.868	1	152	52.9	52.2	0.0	52.8	51	3.5	0.0
145	1855+55.746	1	153	55.9	55.3	0.0	55.8	50	3.5	0.0
146	1859+22.623	1	153	54.5	54.4	0.0	54.5	51	3.4	0.0
147	1862+89.500	1	153	54.3	54.1	0.0	54.3	50	3.4	0.0
148	1866+56.378	1	152	55.0	54.5	0.0	54.9	51	3.4	0.0
149	1870+23.255	1	152	58.0	57.3	0.0	58.0	51	3.4	0.0
150	1873+90.133	1	152	58.4	57.9	0.0	58.3	51	3.4	0.0
151	1877+57.010	1	152	58.3	57.5	0.0	58.2	51	3.4	0.0
152	1881+23.887	1	152	58.8	57.8	0.0	58.6	51	3.4	0.0
153	1884+90.765	2	151	60.0	59.3	0.0	60.0	24	2.4	0.0
154	1888+57.642	2	150	58.0	57.3	0.0	58.0	23	2.4	0.0
155	1892+24.519	2	150	58.0	57.3	0.0	58.0	19	2.2	14.0
156	1895+91.397	2	149	58.0	57.3	0.0	58.0	21	2.1	10.0
157	1899+58.274	2	149	58.6	58.0	0.0	58.6	26	2.3	3.0
158	1903+25.152	2	149	55.9	55.2	0.0	55.9	26	2.4	7.0
159	1906+92.029	2	147	55.9	55.2	0.0	55.9	25	2.4	6.0
160	1910+58.906	2	148	55.2	55.2	0.0	55.2	26	2.4	4.0
161	1914+25.784	2	149	59.3	57.3	0.0	59.3	24	2.4	0.0
162	1917+92.661	2	149	60.7	59.3	0.0	60.0	24	2.4	3.0
163	1921+59.538	2	151	60.7	60.0	0.0	60.7	22	2.3	3.0
164	1925+26.416	2	152	60.7	59.3	0.0	60.7	22	2.3	2.0
165	1928+93.293	2	153	60.7	59.3	0.0	60.7	23	2.4	1.0
166	1932+60.171	2	153	60.7	59.3	0.0	60.7	26	2.4	5.0
167	1936+27.048	2	154	60.7	59.3	0.0	60.7	26	2.5	2.0
168	1939+93.925	2	154	60.7	58.0	0.0	60.0	25	2.5	0.0
169	1943+60.803	2	153	60.0	57.3	0.0	60.0	25	2.5	2.0
170	1947+27.680	2	153	60.7	57.3	0.0	60.0	26	2.6	1.0
171	1950+94.557	2	153	60.7	57.3	0.0	60.0	26	2.5	2.0
172	1954+61.435	2	153	60.7	58.0	0.0	60.0	26	2.6	2.0
173	1958+28.312	2	154	60.7	58.0	0.0	60.0	24	2.7	1.0
174	1961+95.190	2	154	60.7	58.0	0.0	60.0	24	2.7	1.0
175	1965+62.067	2	154	60.7	58.0	0.0	60.0	26	2.7	1.0
176	1969+28.944	2	154	60.7	58.0	0.0	60.0	26	2.7	4.0
177	1972+95.822	2	154	60.7	58.0	0.0	60.0	27	2.7	2.0
178	1976+62.699	2	154	60.7	58.0	0.0	60.0	27	2.8	4.0
179	1980+29.576	2	154	60.7	57.3	0.0	60.0	24	2.8	2.0
180	1983+96.454	2	154	60.0	54.5	0.0	59.3	25	2.7	0.0
181	1987+63.331	2	154	58.6	51.8	0.0	57.3	34	2.9	4.0
182	1991+30.209	1	154	57.6	48.9	0.0	56.3	35	3.0	0.0
183	1994+97.086	1	154	57.9	47.2	0.0	56.3	34	3.1	0.0
184	1998+63.963	1	154	58.3	47.5	0.0	56.7	34	3.3	0.0

Station Number	Station	Number of Lanes	Traffic Volume (vpd)	Speed Mean Cars (mph)	Speed Mean Trucks (mph)	Speed Mean RVs (mph)	Speed Mean All (mph)	Percent Following (%)	Platoon Size	Number of Passes
185	2002+30.841	1	154	58.5	49.0	0.0	57.1	34	3.3	0.0
186	2005+97.718	1	153	58.7	51.3	0.0	57.6	36	3.3	0.0
187	2009+64.595	1	155	59.0	54.1	0.0	58.3	37	3.2	0.0
188	2013+31.473	1	154	59.7	57.3	0.0	59.3	37	3.3	0.0
189	2016+98.350	1	153	60.3	59.5	0.0	60.1	37	3.3	1.0
190	2020+65.228	1	152	60.7	60.8	0.0	60.7	36	3.3	1.0
191	2024+32.105	1	152	61.0	61.2	0.0	61.0	37	3.3	2.0
192	2027+98.982	1	152	61.2	61.2	0.0	61.2	35	3.0	2.0
193	2031+65.860	1	152	61.0	61.2	0.0	61.1	36	2.9	3.0
194	2035+32.737	1	152	60.9	61.2	0.0	60.9	37	3.0	2.0
195	2038+99.614	1	152	60.8	61.1	0.0	60.8	36	2.9	1.0
196	2042+66.492	1	153	60.8	61.0	0.0	60.8	35	2.9	1.0
197	2046+33.369	1	152	60.6	60.8	0.0	60.7	35	2.9	1.0
198	2050+00.247	1	151	60.4	60.6	0.0	60.5	35	3.0	2.0
199	2053+67.124	1	151	60.2	60.5	0.0	60.3	34	2.9	1.0
200	2057+34.001	1	151	60.1	60.3	0.0	60.1	34	2.9	0.0
201	2061+00.879	1	151	59.8	59.9	0.0	59.8	34	2.9	0.0
202	2064+67.756	1	150	59.7	59.5	0.0	59.7	36	3.0	0.0
203	2068+34.633	1	150	59.8	59.4	0.0	59.7	37	3.1	0.0
204	2072+01.511	1	149	59.8	59.5	0.0	59.7	37	3.1	0.0
205	2075+68.388	1	148	59.8	59.5	0.0	59.7	38	3.2	0.0
206	2079+35.266	1	149	60.0	59.7	0.0	59.9	36	3.2	1.0
207	2083+02.143	1	150	60.4	59.6	0.0	60.3	38	3.2	0.0
208	2086+69.020	1	150	60.5	59.4	0.0	60.3	39	3.1	1.0
209	2090+35.898	1	151	60.3	59.5	0.0	60.1	38	3.0	4.0
210	2094+02.775	1	151	59.9	59.4	0.0	59.9	38	3.0	1.0
211	2097+69.652	1	151	59.6	59.0	0.0	59.5	38	3.0	0.0
212	2101+36.530	1	152	59.2	58.8	0.0	59.1	38	3.0	0.0
213	2105+03.407	1	152	59.0	58.8	0.0	59.0	37	3.0	0.0
214	2108+70.285	1	152	59.1	59.3	0.0	59.2	37	3.0	0.0
215	2112+37.162	1	152	59.4	59.7	0.0	59.5	38	3.1	0.0
216	2116+04.039	1	152	59.5	59.5	0.0	59.5	38	3.1	1.0
217	2119+70.917	1	152	59.5	59.4	0.0	59.5	38	3.1	2.0
218	2123+37.794	1	152	59.6	59.0	0.0	59.5	38	3.1	0.0
219	2127+04.671	1	152	60.3	59.3	0.0	60.1	38	3.1	0.0
220	2130+71.549	2	152	60.7	59.3	0.0	60.7	17	2.4	0.0
221	2134+38.426	2	152	60.7	60.0	0.0	60.7	16	2.3	0.0
222	2138+05.303	2	153	60.7	60.0	0.0	60.7	18	2.3	5.0
223	2141+72.181	2	153	60.7	60.0	0.0	60.7	18	2.3	6.0
224	2145+39.058	2	153	60.7	60.0	0.0	60.7	20	2.4	5.0
225	2149+05.936	2	153	60.7	60.0	0.0	60.7	22	2.3	4.0
226	2152+72.813	2	153	60.7	60.0	0.0	60.7	24	2.4	4.0
227	2156+39.690	2	153	60.7	60.0	0.0	60.7	23	2.5	5.0
228	2160+06.568	2	153	60.7	60.0	0.0	60.7	21	2.6	2.0
229	2163+73.445	2	153	60.7	59.3	0.0	60.7	24	2.7	4.0
230	2167+40.322	2	153	60.7	59.3	0.0	60.7	23	2.6	3.0
231	2171+07.200	2	154	60.7	59.3	0.0	60.7	22	2.5	2.0
232	2174+74.077	2	153	60.7	59.3	0.0	60.7	20	2.5	2.0
233	2178+40.955	2	152	60.7	60.0	0.0	60.7	22	2.5	2.0
234	2182+07.832	2	152	60.7	60.0	0.0	60.7	18	2.5	5.0

Station Number	Station	Number of Lanes	Traffic Volume (vpd)	Speed Mean Cars (mph)	Speed Mean Trucks (mph)	Speed Mean RVs (mph)	Speed Mean All (mph)	Percent Following (%)	Platoon Size	Number of Passes
235	2185+74.709	2	151	60.7	60.0	0.0	60.7	17	2.4	4.0
236	2189+41.587	2	150	58.6	57.3	0.0	58.0	17	2.6	3.0
237	2193+08.464	2	151	57.3	55.9	0.0	57.3	18	2.4	3.0
238	2196+75.341	2	151	57.3	55.9	0.0	57.3	17	2.5	3.0
239	2200+42.219	2	151	57.3	55.9	0.0	57.3	16	2.3	5.0
240	2204+09.096	2	150	60.7	55.2	0.0	60.0	16	2.3	3.0
241	2207+75.974	2	151	60.7	55.2	0.0	60.0	19	2.7	3.0
242	2211+42.851	2	151	60.7	55.2	0.0	60.0	19	2.5	2.0
243	2215+09.728	2	151	60.7	56.6	0.0	60.0	20	2.8	3.0
244	2218+76.606	2	151	60.7	57.3	0.0	60.0	20	2.7	1.0
245	2222+43.483	2	151	60.7	58.6	0.0	60.0	18	2.7	1.0
246	2226+10.360	2	151	60.0	58.0	0.0	60.0	25	3.4	1.0
247	2229+77.238	2	151	60.0	54.5	0.0	59.3	28	3.1	4.0
248	2233+44.115	1	150	59.8	55.2	0.0	59.1	29	3.0	12.0
249	2237+10.993	1	150	59.5	55.3	0.0	58.8	30	3.0	0.0
250	2240+77.870	1	151	57.5	54.5	0.0	57.1	30	3.0	0.0
251	2244+44.747	1	150	55.3	53.7	0.0	55.0	29	3.0	0.0
252	2248+11.625	1	150	55.2	54.3	0.0	55.1	29	3.2	0.0
253	2251+78.502	1	149	55.2	54.7	0.0	55.1	31	3.3	0.0
254	2255+45.379	1	149	55.2	54.8	0.0	55.2	31	3.3	0.0
255	2259+12.257	1	149	58.4	57.1	0.0	58.2	30	3.3	0.0
256	2262+79.134	1	150	59.0	58.2	0.0	58.8	30	3.3	0.0
257	2266+46.012	1	150	55.4	54.3	0.0	55.2	30	3.3	0.0
258	2270+12.889	1	150	55.1	53.7	0.0	54.9	29	3.2	0.0
259	2273+79.766	1	150	55.0	53.5	0.0	54.8	30	3.3	0.0
260	2277+46.644	1	151	55.1	53.4	0.0	54.8	30	3.2	0.0
261	2281+13.521	1	151	55.1	53.3	0.0	54.8	32	3.1	0.0
262	2284+80.398	1	151	55.2	53.4	0.0	55.0	31	3.1	0.0
263	2288+47.276	1	151	57.7	54.5	0.0	57.2	32	3.2	0.0
264	2292+14.153	1	152	59.8	56.5	0.0	59.3	32	3.2	1.0
265	2295+81.031	1	152	59.9	57.7	0.0	59.5	32	3.2	0.0
266	2299+47.908	1	152	60.0	58.4	0.0	59.7	32	3.2	0.0
267	2303+14.785	1	152	60.1	58.7	0.0	59.9	32	3.2	0.0
268	2306+81.663	1	152	60.1	58.9	0.0	59.9	32	3.1	1.0
269	2310+48.540	1	152	59.9	59.0	0.0	59.8	32	3.1	0.0
270	2314+15.417	1	152	55.6	55.0	0.0	55.6	32	3.0	0.0
271	2317+82.295	1	152	55.2	54.3	0.0	55.0	32	2.9	0.0
272	2321+49.172	1	152	54.8	53.6	0.0	54.6	34	3.0	0.0
273	2325+16.050	1	154	55.4	53.9	0.0	55.2	34	2.9	0.0
274	2328+82.927	1	155	59.3	55.8	0.0	58.7	36	2.9	0.0
275	2332+49.804	1	155	59.9	57.1	0.0	59.5	37	2.9	1.0
276	2336+16.682	1	155	60.5	58.2	0.0	60.1	38	3.0	2.0
277	2339+83.559	1	155	60.8	58.8	0.0	60.5	38	3.0	3.0
278	2343+50.436	1	155	60.9	59.0	0.0	60.6	37	2.9	6.0
279	2347+17.314	1	155	60.8	59.1	0.0	60.5	37	2.9	2.0
280	2350+84.191	1	155	60.5	59.2	0.0	60.3	37	2.9	1.0
281	2354+51.069	1	155	60.4	59.0	0.0	60.2	37	2.9	0.0
282	2358+17.946	1	155	60.2	59.1	0.0	60.1	37	2.9	1.0
283	2361+84.823	1	155	60.1	59.3	0.0	59.9	37	2.9	3.0
284	2365+51.701	1	156	59.9	59.2	0.0	59.9	36	3.1	0.0



Station Number	Station	Number of Lanes	Traffic Volume (vpd)	Speed Mean Cars (mph)	Speed Mean Trucks (mph)	Speed Mean RVs (mph)	Speed Mean All (mph)	Percent Following (%)	Platoon Size	Number of Passes
285	2369+18.578	1	156	59.9	59.0	0.0	59.7	35	3.1	0.0
286	2372+85.455	1	156	59.9	59.0	0.0	59.7	34	3.0	0.0
287	2376+52.333	1	156	57.0	55.9	0.0	56.8	33	3.2	0.0
288	2380+19.210	1	156	54.3	53.1	0.0	54.1	33	3.2	0.0
289	2383+86.087	1	157	55.4	52.8	0.0	55.0	32	3.2	0.0
290	2387+52.965	1	157	54.3	52.4	0.0	54.0	32	3.2	0.0
291	2391+19.842	1	159	51.8	50.4	0.0	51.6	33	3.1	0.0
292	2394+86.720	1	159	51.8	50.0	0.0	51.5	35	3.3	0.0
293	2398+53.597	1	159	52.0	50.5	0.0	51.8	35	3.3	2.0
294	2402+20.474	1	159	56.0	52.0	0.0	55.4	37	3.5	4.0
295	2405+87.352	1	159	52.0	50.9	0.0	51.9	36	3.4	2.0
296	2409+54.229	1	159	51.7	50.0	0.0	51.4	36	3.3	0.0
297	2413+21.106	1	159	51.6	49.6	0.0	51.3	35	3.4	0.0
298	2416+87.984	1	159	54.9	50.8	0.0	54.2	35	3.5	0.0
299	2420+54.861	1	159	58.9	53.3	0.0	58.0	36	3.5	0.0
300	2424+21.739	1	159	60.2	55.3	0.0	59.4	36	3.5	0.0

Table 6 below reports spot traffic operational data collected by the simulation at each data collection station for travel in direction of decreasing stations. These data are analogous to data that would be collected by a traffic data recorder placed at the specified location on the highway during the simulation time. The data include hourly traffic volume; measured mean speed of cars, trucks, and recreational vehicles; mean and standard deviation speed for all vehicles combined; percent of vehicles following at a headway of less than 4 seconds; the average platoon size; and number of passes. A separate table is produced for each direction of travel. The data in this station summary data tables are used to create graphs.

**Table 6. Station Summary (Decreasing)**

Station Number	Station	Number of Lanes	Traffic Volume (vpd)	Speed Mean Cars (mph)	Speed Mean Trucks (mph)	Speed Mean RVs (mph)	Speed Mean All (mph)	Percent Following (%)	Platoon Size	Number of Passes
1	2424+21.739	1	91	61.9	61.1	0.0	61.8	29	2.9	0.0
2	2420+54.861	1	91	62.4	60.1	0.0	62.0	29	2.9	0.0
3	2416+87.984	1	90	60.5	57.5	0.0	60.1	28	2.8	0.0
4	2413+21.106	1	88	55.5	52.0	0.0	55.0	26	2.6	1.0
5	2409+54.229	1	88	55.4	51.2	0.0	54.8	25	2.6	3.0
6	2405+87.352	1	88	55.2	50.7	0.0	54.5	27	2.5	2.0
7	2402+20.474	1	87	58.8	53.0	0.0	57.9	25	2.5	3.0
8	2398+53.597	1	89	54.5	51.4	0.0	54.0	29	2.7	0.0
9	2394+86.720	1	89	54.1	50.5	0.0	53.6	29	2.7	1.0
10	2391+19.842	1	89	54.1	50.0	0.0	53.5	25	2.5	0.0
11	2387+52.965	1	91	55.2	50.7	0.0	54.5	25	2.4	4.0
12	2383+86.087	1	91	59.0	54.7	0.0	58.4	28	2.5	0.0
13	2380+19.210	1	90	56.0	52.8	0.0	55.5	31	2.8	1.0
14	2376+52.333	1	90	56.8	53.0	0.0	56.3	30	2.7	0.0
15	2372+85.455	1	90	61.0	56.0	0.0	60.3	27	2.6	2.0
16	2369+18.578	1	90	61.4	57.8	0.0	60.9	27	2.6	0.0

Station Number	Station	Number of Lanes	Traffic Volume (vpd)	Speed Mean Cars (mph)	Speed Mean Trucks (mph)	Speed Mean RVs (mph)	Speed Mean All (mph)	Percent Following (%)	Platoon Size	Number of Passes
17	2365+51.701	1	90	61.4	58.4	0.0	61.0	26	2.5	0.0
18	2361+84.823	1	90	61.4	58.3	0.0	61.0	26	2.5	0.0
19	2358+17.946	1	90	61.4	58.4	0.0	61.0	26	2.5	1.0
20	2354+51.069	1	90	61.6	58.6	0.0	61.2	26	2.5	1.0
21	2350+84.191	1	90	61.4	58.4	0.0	61.0	26	2.5	0.0
22	2347+17.314	1	90	61.4	58.5	0.0	61.0	24	2.5	0.0
23	2343+50.436	1	90	61.5	58.3	0.0	61.0	26	2.5	1.0
24	2339+83.559	1	90	61.6	58.3	0.0	61.1	26	2.5	0.0
25	2336+16.682	1	90	61.6	58.5	0.0	61.2	26	2.5	1.0
26	2332+49.804	1	90	61.6	58.4	0.0	61.2	26	2.5	1.0
27	2328+82.927	1	90	61.6	58.4	0.0	61.2	26	2.5	0.0
28	2325+16.050	1	90	59.1	55.3	0.0	58.6	24	2.5	0.0
29	2321+49.172	1	90	57.2	52.6	0.0	56.5	24	2.5	1.0
30	2317+82.295	1	90	56.9	52.7	0.0	56.3	24	2.6	1.0
31	2314+15.417	1	90	56.7	53.0	0.0	56.2	26	2.5	0.0
32	2310+48.540	1	90	60.3	55.3	0.0	59.7	26	2.5	0.0
33	2306+81.663	1	90	61.0	57.3	0.0	60.5	26	2.5	0.0
34	2303+14.785	1	90	61.2	58.3	0.0	60.8	24	2.6	0.0
35	2299+47.908	1	90	61.2	59.0	0.0	60.9	26	2.5	1.0
36	2295+81.031	1	90	61.1	58.6	0.0	60.8	26	2.5	0.0
37	2292+14.153	1	90	61.2	58.7	0.0	60.9	26	2.5	0.0
38	2288+47.276	1	90	61.3	58.3	0.0	60.9	24	2.4	0.0
39	2284+80.398	1	90	57.4	52.9	0.0	56.7	24	2.4	2.0
40	2281+13.521	1	90	57.1	52.5	0.0	56.5	24	2.4	2.0
41	2277+46.644	1	90	57.1	53.2	0.0	56.5	24	2.6	0.0
42	2273+79.766	1	90	56.8	53.6	0.0	56.3	22	2.5	0.0
43	2270+12.889	1	90	56.7	53.3	0.0	56.3	21	2.6	1.0
44	2266+46.012	1	90	56.5	52.5	0.0	56.0	21	2.6	0.0
45	2262+79.134	1	90	58.4	52.0	0.0	57.5	20	2.6	0.0
46	2259+12.257	1	90	60.4	52.3	0.0	59.3	21	2.7	0.0
47	2255+45.379	1	90	56.6	52.0	0.0	56.0	21	2.7	1.0
48	2251+78.502	1	90	56.3	52.4	0.0	55.8	20	2.6	1.0
49	2248+11.625	1	91	56.2	52.8	0.0	55.7	20	2.6	0.0
50	2244+44.747	1	91	56.5	53.4	0.0	56.0	19	2.5	0.0
51	2240+77.870	1	91	57.7	54.4	0.0	57.3	18	2.6	2.0
52	2237+10.993	1	91	61.0	57.9	0.0	60.5	18	2.6	0.0
53	2233+44.115	1	91	61.2	59.4	0.0	60.9	18	2.6	0.0
54	2229+77.238	2	91	61.4	59.3	0.0	61.4	10	2.1	0.0
55	2226+10.360	2	91	61.4	60.0	0.0	61.4	10	2.0	0.0
56	2222+43.483	2	91	62.0	60.0	0.0	61.4	9	2.0	0.0
57	2218+76.606	2	91	61.4	60.0	0.0	61.4	8	2.2	1.0
58	2215+09.728	2	91	62.0	60.0	0.0	61.4	10	2.0	3.0
59	2211+42.851	2	90	62.0	60.0	0.0	61.4	11	2.0	5.0
60	2207+75.974	2	90	61.4	60.0	0.0	61.4	13	2.1	0.0
61	2204+09.096	2	90	62.0	60.0	0.0	61.4	13	2.2	0.0
62	2200+42.219	2	90	60.0	57.3	0.0	60.0	12	2.1	0.0
63	2196+75.341	2	90	58.0	55.9	0.0	58.0	11	2.1	0.0
64	2193+08.464	2	90	58.0	55.9	0.0	58.0	10	2.1	3.0
65	2189+41.587	2	90	58.0	55.9	0.0	58.0	10	2.1	0.0
66	2185+74.709	2	90	61.4	57.3	0.0	60.7	10	2.0	2.0

Station Number	Station	Number of Lanes	Traffic Volume (vpd)	Speed Mean Cars (mph)	Speed Mean Trucks (mph)	Speed Mean RVs (mph)	Speed Mean All (mph)	Percent Following (%)	Platoon Size	Number of Passes
67	2182+07.832	2	90	61.4	57.3	0.0	61.4	11	2.0	1.0
68	2178+40.955	2	90	61.4	56.6	0.0	60.7	11	2.1	2.0
69	2174+74.077	2	90	61.4	56.6	0.0	60.7	11	2.3	0.0
70	2171+07.200	2	90	61.4	57.3	0.0	61.4	9	2.3	1.0
71	2167+40.322	2	90	61.4	58.6	0.0	61.4	10	2.5	1.0
72	2163+73.445	2	90	62.0	60.0	0.0	61.4	11	2.3	1.0
73	2160+06.568	2	90	62.0	60.0	0.0	61.4	11	2.4	0.0
74	2156+39.690	2	90	62.0	60.0	0.0	61.4	10	2.5	0.0
75	2152+72.813	2	90	62.0	60.0	0.0	61.4	10	2.5	0.0
76	2149+05.936	2	89	62.0	59.3	0.0	61.4	8	2.4	1.0
77	2145+39.058	2	89	62.0	59.3	0.0	61.4	6	2.3	1.0
78	2141+72.181	2	89	62.0	58.6	0.0	61.4	7	2.2	1.0
79	2138+05.303	2	89	62.0	58.6	0.0	61.4	9	2.1	1.0
80	2134+38.426	2	89	61.4	58.0	0.0	61.4	6	2.7	0.0
81	2130+71.549	2	89	61.4	58.6	0.0	61.4	12	2.6	1.0
82	2127+04.671	1	89	62.0	59.6	0.0	61.6	14	2.5	0.0
83	2123+37.794	1	89	61.8	59.9	0.0	61.6	15	2.4	0.0
84	2119+70.917	1	89	61.8	60.1	0.0	61.6	17	2.4	0.0
85	2116+04.039	1	91	61.6	59.5	0.0	61.3	18	2.3	0.0
86	2112+37.162	1	92	61.4	59.0	0.0	61.1	17	2.3	0.0
87	2108+70.285	1	92	61.6	59.0	0.0	61.3	17	2.3	2.0
88	2105+03.407	1	93	61.6	59.5	0.0	61.3	17	2.3	1.0
89	2101+36.530	1	93	61.6	59.8	0.0	61.4	17	2.3	0.0
90	2097+69.652	1	93	61.6	59.9	0.0	61.4	17	2.3	0.0
91	2094+02.775	1	93	61.8	59.9	0.0	61.5	13	2.1	0.0
92	2090+35.898	1	93	61.9	59.9	0.0	61.6	13	2.1	1.0
93	2086+69.020	1	93	62.0	59.9	0.0	61.7	13	2.1	0.0
94	2083+02.143	1	93	62.0	59.7	0.0	61.7	13	2.1	2.0
95	2079+35.266	1	93	61.9	59.5	0.0	61.6	13	2.1	0.0
96	2075+68.388	1	92	61.9	59.2	0.0	61.5	13	2.1	0.0
97	2072+01.511	1	92	61.8	59.3	0.0	61.5	13	2.1	0.0
98	2068+34.633	1	92	61.8	59.6	0.0	61.5	14	2.1	0.0
99	2064+67.756	1	92	61.8	59.7	0.0	61.6	15	2.1	0.0
100	2061+00.879	1	91	61.9	59.7	0.0	61.6	14	2.1	1.0
101	2057+34.001	1	90	61.8	59.7	0.0	61.6	13	2.1	1.0
102	2053+67.124	1	90	62.0	59.8	0.0	61.6	12	2.1	1.0
103	2050+00.247	1	90	62.0	59.9	0.0	61.6	12	2.1	1.0
104	2046+33.369	1	91	61.9	59.9	0.0	61.6	12	2.1	0.0
105	2042+66.492	1	91	61.8	59.9	0.0	61.6	12	2.1	0.0
106	2038+99.614	1	91	61.8	59.9	0.0	61.6	12	2.1	0.0
107	2035+32.737	1	91	61.8	59.9	0.0	61.6	12	2.1	0.0
108	2031+65.860	1	91	61.8	59.4	0.0	61.5	11	2.1	0.0
109	2027+98.982	1	91	61.6	57.4	0.0	61.0	12	2.1	1.0
110	2024+32.105	1	91	61.0	54.9	0.0	60.1	12	2.1	0.0
111	2020+65.228	1	91	60.7	52.4	0.0	59.5	12	2.1	0.0
112	2016+98.350	1	91	60.3	50.1	0.0	58.9	12	2.1	1.0
113	2013+31.473	1	91	60.8	48.8	0.0	59.1	11	2.3	0.0
114	2009+64.595	1	91	61.2	49.2	0.0	59.5	11	2.3	0.0
115	2005+97.718	1	91	61.4	50.8	0.0	59.9	11	2.3	0.0
116	2002+30.841	1	91	61.4	53.0	0.0	60.2	12	2.2	0.0

Station Number	Station	Number of Lanes	Traffic Volume (vpd)	Speed Mean Cars (mph)	Speed Mean Trucks (mph)	Speed Mean RVs (mph)	Speed Mean All (mph)	Percent Following (%)	Platoon Size	Number of Passes
117	1998+63.963	1	91	61.5	55.8	0.0	60.7	12	2.2	0.0
118	1994+97.086	1	91	61.6	58.6	0.0	61.1	11	2.3	0.0
119	1991+30.209	1	91	61.8	59.7	0.0	61.6	11	2.3	0.0
120	1987+63.331	2	91	62.0	59.3	0.0	61.4	1	2.0	0.0
121	1983+96.454	2	91	62.0	59.3	0.0	61.4	1	2.0	1.0
122	1980+29.576	2	91	62.0	59.3	0.0	61.4	2	2.0	0.0
123	1976+62.699	2	91	62.0	59.3	0.0	61.4	4	2.0	1.0
124	1972+95.822	2	91	62.0	59.3	0.0	61.4	7	2.0	1.0
125	1969+28.944	2	91	62.0	59.3	0.0	61.4	9	2.1	1.0
126	1965+62.067	2	91	62.0	59.3	0.0	61.4	7	2.0	0.0
127	1961+95.190	2	91	62.0	59.3	0.0	61.4	8	2.0	0.0
128	1958+28.312	2	92	62.0	59.3	0.0	61.4	9	2.0	1.0
129	1954+61.435	2	93	62.0	59.3	0.0	61.4	10	2.0	2.0
130	1950+94.557	2	93	61.4	59.3	0.0	61.4	11	2.0	0.0
131	1947+27.680	2	93	61.4	59.3	0.0	61.4	11	2.0	0.0
132	1943+60.803	2	93	61.4	59.3	0.0	61.4	10	2.0	1.0
133	1939+93.925	2	93	61.4	59.3	0.0	61.4	8	2.0	0.0
134	1936+27.048	2	93	61.4	59.3	0.0	61.4	8	2.0	1.0
135	1932+60.171	2	93	61.4	59.3	0.0	61.4	8	2.0	2.0
136	1928+93.293	2	93	61.4	59.3	0.0	61.4	9	2.0	1.0
137	1925+26.416	2	93	61.4	59.3	0.0	61.4	8	2.0	0.0
138	1921+59.538	2	93	61.4	59.3	0.0	61.4	11	2.0	1.0
139	1917+92.661	2	93	61.4	59.3	0.0	61.4	12	2.0	1.0
140	1914+25.784	2	93	61.4	59.3	0.0	61.4	9	2.0	2.0
141	1910+58.906	2	93	56.6	53.9	0.0	56.6	9	2.0	0.0
142	1906+92.029	2	93	56.6	53.9	0.0	56.6	10	2.0	2.0
143	1903+25.152	2	93	56.6	53.2	0.0	55.9	11	2.0	3.0
144	1899+58.274	2	93	57.3	52.5	0.0	56.6	9	2.0	0.0
145	1895+91.397	2	93	58.6	51.8	0.0	58.0	9	2.0	0.0
146	1892+24.519	2	93	58.6	51.8	0.0	58.0	4	2.0	0.0
147	1888+57.642	2	93	58.6	51.1	0.0	57.3	6	2.0	0.0
148	1884+90.765	2	93	60.0	51.1	0.0	59.3	9	2.1	0.0
149	1881+23.887	1	93	61.5	51.1	0.0	60.1	9	2.1	0.0
150	1877+57.010	1	93	61.4	50.9	0.0	60.0	10	2.1	0.0
151	1873+90.133	1	93	61.3	50.5	0.0	59.8	12	2.2	0.0
152	1870+23.255	1	92	61.2	50.0	0.0	59.6	12	2.2	0.0
153	1866+56.378	1	92	59.4	48.9	0.0	57.9	11	2.3	1.0
154	1862+89.500	1	92	58.4	47.9	0.0	56.9	11	2.3	0.0
155	1859+22.623	1	91	58.1	47.3	0.0	56.5	12	2.2	1.0
156	1855+55.746	1	90	58.2	46.7	0.0	56.5	12	2.1	0.0
157	1851+88.868	1	90	56.2	45.8	0.0	54.7	12	2.1	0.0
158	1848+21.991	1	90	55.7	45.3	0.0	54.2	13	2.1	0.0
159	1844+55.114	1	90	55.6	45.1	0.0	54.1	14	2.3	2.0
160	1840+88.236	1	90	55.3	44.9	0.0	53.8	12	2.4	1.0
161	1837+21.359	1	90	55.4	44.5	0.0	53.9	13	2.5	0.0
162	1833+54.482	1	91	59.2	43.6	0.0	56.9	15	2.6	1.0
163	1829+87.604	1	91	59.7	42.5	0.0	57.2	18	2.3	1.0
164	1826+20.727	1	91	59.6	41.8	0.0	57.1	15	2.4	2.0
165	1822+53.849	1	91	59.5	41.3	0.0	56.9	13	2.3	1.0
166	1818+86.972	1	92	56.4	41.0	0.0	54.2	12	2.4	0.0

Station Number	Station	Number of Lanes	Traffic Volume (vpd)	Speed Mean Cars (mph)	Speed Mean Trucks (mph)	Speed Mean RVs (mph)	Speed Mean All (mph)	Percent Following (%)	Platoon Size	Number of Passes
167	1815+20.095	1	91	55.9	42.0	0.0	53.9	12	2.4	1.0
168	1811+53.217	1	91	56.0	43.0	0.0	54.1	13	2.3	0.0
169	1807+86.340	1	91	56.0	43.8	0.0	54.3	13	2.3	1.0
170	1804+19.463	1	91	59.1	43.8	0.0	56.9	14	2.3	0.0
171	1800+52.585	1	91	60.1	43.0	0.0	57.6	13	2.3	2.0
172	1796+85.708	1	90	60.3	43.4	0.0	58.1	13	2.3	0.0
173	1793+18.830	1	90	61.0	44.6	0.0	58.8	13	2.3	0.0
174	1789+51.953	1	90	61.3	46.9	0.0	59.4	13	2.3	0.0
175	1785+85.076	1	91	61.4	49.8	0.0	59.9	13	2.3	2.0
176	1782+18.198	1	91	61.3	52.0	0.0	60.1	12	2.4	0.0
177	1778+51.321	1	91	61.2	53.5	0.0	60.1	12	2.4	0.0
178	1774+84.444	1	91	61.3	53.5	0.0	60.3	12	2.4	0.0
179	1771+17.566	2	91	60.7	51.1	0.0	60.0	4	2.3	0.0
180	1767+50.689	2	91	60.7	49.1	0.0	59.3	7	2.2	0.0
181	1763+83.811	2	91	60.7	47.7	0.0	58.6	8	2.2	0.0
182	1760+16.934	2	91	60.7	47.7	0.0	59.3	7	2.2	1.0
183	1756+50.057	2	92	61.4	49.1	0.0	59.3	6	2.2	3.0
184	1752+83.179	2	92	61.4	51.1	0.0	60.0	11	2.0	2.0
185	1749+16.302	2	92	58.0	52.5	0.0	57.3	11	2.0	0.0
186	1745+49.425	2	92	58.0	53.9	0.0	57.3	9	2.0	4.0
187	1741+82.547	2	92	58.0	53.9	0.0	57.3	9	2.0	1.0
188	1738+15.670	2	92	58.6	54.5	0.0	58.0	9	2.0	2.0
189	1734+48.792	2	92	61.4	54.5	0.0	60.0	9	2.1	3.0
190	1730+81.915	2	91	60.7	52.5	0.0	60.0	12	2.1	2.0
191	1727+15.038	2	91	58.6	50.5	0.0	58.0	11	2.1	1.0
192	1723+48.160	2	90	58.6	48.4	0.0	57.3	10	2.1	0.0
193	1719+81.283	2	90	58.6	47.7	0.0	57.3	9	2.1	0.0
194	1716+14.406	2	90	60.7	48.4	0.0	59.3	9	2.1	1.0
195	1712+47.528	2	90	61.4	50.5	0.0	60.0	9	2.1	0.0
196	1708+80.651	2	88	61.4	52.5	0.0	60.7	8	2.2	0.0
197	1705+13.773	2	88	61.4	52.5	0.0	60.0	8	2.0	0.0
198	1701+46.896	2	87	59.3	51.1	0.0	58.0	3	2.0	0.0
199	1697+80.019	2	87	59.3	51.1	0.0	58.0	3	2.0	1.0
200	1694+13.141	2	87	59.3	51.8	0.0	58.0	3	2.0	0.0
201	1690+46.264	2	87	61.4	53.9	0.0	60.7	5	2.0	0.0
202	1686+79.387	2	88	58.0	53.9	0.0	57.3	7	2.0	2.0
203	1683+12.509	2	88	58.0	54.5	0.0	57.3	7	2.0	0.0
204	1679+45.632	2	88	58.0	54.5	0.0	57.3	7	2.0	0.0
205	1675+78.754	2	89	60.7	56.6	0.0	60.0	7	2.0	1.0
206	1672+11.877	2	91	58.0	54.5	0.0	57.3	6	2.0	0.0
207	1668+45.000	2	91	58.0	54.5	0.0	57.3	7	2.0	1.0
208	1664+78.122	2	91	58.0	53.9	0.0	57.3	10	2.0	1.0
209	1661+11.245	1	90	61.8	57.0	0.0	61.0	11	2.0	0.0
210	1657+44.368	1	90	62.0	59.0	0.0	61.5	12	2.0	0.0
211	1653+77.490	1	90	61.9	59.3	0.0	61.5	12	2.0	0.0
212	1650+10.613	1	90	57.5	54.2	0.0	56.9	10	2.0	1.0
213	1646+43.735	1	90	57.4	54.2	0.0	56.9	10	2.0	0.0
214	1642+76.858	1	90	57.2	54.2	0.0	56.7	9	2.0	0.0
215	1639+09.981	1	90	57.1	54.2	0.0	56.7	8	2.0	0.0
216	1635+43.103	1	90	57.2	54.2	0.0	56.7	8	2.0	0.0

Station Number	Station	Number of Lanes	Traffic Volume (vpd)	Speed Mean Cars (mph)	Speed Mean Trucks (mph)	Speed Mean RVs (mph)	Speed Mean All (mph)	Percent Following (%)	Platoon Size	Number of Passes
217	1631+76.226	1	90	59.7	56.8	0.0	59.3	9	2.1	0.0
218	1628+09.349	1	90	61.8	59.4	0.0	61.4	9	2.1	0.0
219	1624+42.471	2	91	61.4	59.3	0.0	61.4	2	2.0	0.0
220	1620+75.594	2	91	58.6	55.2	0.0	58.0	3	2.0	0.0
221	1617+08.716	2	91	58.6	55.2	0.0	58.0	2	2.0	1.0
222	1613+41.839	2	91	58.6	55.2	0.0	58.0	1	2.0	1.0
223	1609+74.962	2	91	58.6	55.2	0.0	58.0	1	2.0	1.0
224	1606+08.084	2	91	58.6	53.2	0.0	58.0	2	2.0	2.0
225	1602+41.207	2	91	58.0	51.1	0.0	57.3	4	2.0	2.0
226	1598+74.330	2	91	56.6	48.4	0.0	55.2	7	2.0	0.0
227	1595+07.452	2	91	56.6	46.4	0.0	54.5	8	2.0	0.0
228	1591+40.575	2	91	55.9	45.0	0.0	54.5	6	2.0	1.0
229	1587+73.698	2	91	55.9	43.6	0.0	54.5	6	2.0	0.0
230	1584+06.820	2	90	56.6	42.3	0.0	53.9	4	2.0	0.0
231	1580+39.943	2	89	57.3	42.3	0.0	55.2	3	2.0	0.0
232	1576+73.065	2	89	59.3	41.6	0.0	56.6	4	2.0	2.0
233	1573+06.188	2	88	59.3	40.9	0.0	56.6	3	2.0	3.0
234	1569+39.311	2	89	55.9	41.6	0.0	53.9	4	2.0	0.0
235	1565+72.433	2	89	55.9	40.9	0.0	53.9	4	2.0	0.0
236	1562+05.556	2	89	55.9	40.9	0.0	53.9	6	2.3	2.0
237	1558+38.679	2	89	56.6	41.6	0.0	53.9	4	2.3	1.0
238	1554+71.801	2	90	58.6	43.6	0.0	56.6	4	2.0	0.0
239	1551+04.924	2	90	61.4	47.0	0.0	59.3	4	2.0	0.0
240	1547+38.046	2	90	57.3	49.1	0.0	55.9	4	2.0	0.0
241	1543+71.169	2	90	57.3	51.8	0.0	56.6	2	2.0	1.0
242	1540+04.292	2	90	57.3	53.9	0.0	56.6	2	2.0	0.0
243	1536+37.414	2	90	57.3	53.9	0.0	56.6	2	2.0	2.0
244	1532+70.537	2	89	57.3	53.9	0.0	56.6	2	2.0	3.0
245	1529+03.660	2	89	57.3	53.9	0.0	56.6	2	2.0	1.0
246	1525+36.782	2	89	57.3	53.9	0.0	56.6	4	2.0	1.0
247	1521+69.905	2	89	60.0	54.5	0.0	59.3	7	2.0	0.0
248	1518+03.027	2	89	60.0	54.5	0.0	59.3	6	2.0	1.0
249	1514+36.150	2	89	59.3	53.2	0.0	58.6	8	2.0	0.0
250	1510+69.273	2	89	59.3	51.1	0.0	58.0	3	2.0	0.0
251	1507+02.395	2	89	59.3	49.1	0.0	58.0	3	2.0	1.0
252	1503+35.518	2	89	56.6	47.7	0.0	55.2	4	2.0	0.0
253	1499+68.641	2	89	56.6	48.4	0.0	55.2	3	2.0	1.0
254	1496+01.763	2	89	56.6	49.8	0.0	55.9	3	2.0	0.0
255	1492+34.886	2	89	57.3	51.8	0.0	55.9	3	2.0	0.0
256	1488+68.008	2	89	57.3	53.2	0.0	56.6	4	2.0	1.0
257	1485+01.131	2	89	57.3	53.2	0.0	56.6	4	2.0	0.0
258	1481+34.254	2	89	60.0	55.9	0.0	59.3	3	2.0	0.0
259	1477+67.376	2	89	57.3	53.9	0.0	57.3	2	2.0	0.0
260	1474+00.499	2	89	57.3	53.9	0.0	56.6	2	2.0	0.0
261	1470+33.622	2	89	57.3	53.9	0.0	56.6	2	2.0	0.0
262	1466+66.744	2	89	58.6	53.2	0.0	58.0	2	2.0	0.0
263	1462+99.867	2	89	60.7	52.5	0.0	59.3	3	2.0	2.0
264	1459+32.989	2	89	61.4	51.8	0.0	60.0	3	2.0	1.0
265	1455+66.112	2	90	61.4	51.1	0.0	59.3	3	2.0	1.0
266	1451+99.235	2	90	61.4	50.5	0.0	60.0	8	2.0	1.0

Station Number	Station	Number of Lanes	Traffic Volume (vpd)	Speed Mean Cars (mph)	Speed Mean Trucks (mph)	Speed Mean RVs (mph)	Speed Mean All (mph)	Percent Following (%)	Platoon Size	Number of Passes
267	1448+32.357	1	90	62.0	51.5	0.0	60.3	8	2.0	1.0
268	1444+65.480	1	90	62.2	53.3	0.0	60.8	8	2.0	0.0
269	1440+98.603	1	90	61.5	55.3	0.0	60.5	10	2.0	0.0
270	1437+31.725	1	90	57.2	53.5	0.0	56.6	7	2.0	0.0
271	1433+64.848	1	90	57.3	53.5	0.0	56.7	9	2.0	0.0
272	1429+97.970	1	90	57.3	53.5	0.0	56.7	9	2.0	1.0
273	1426+31.093	1	90	61.0	54.5	0.0	59.9	9	2.0	0.0
274	1422+64.216	1	90	61.2	54.1	0.0	60.1	8	2.0	1.0
275	1418+97.338	1	90	57.1	52.5	0.0	56.4	7	2.0	0.0
276	1415+30.461	1	91	57.0	52.2	0.0	56.3	7	2.0	0.0
277	1411+63.584	1	91	56.9	52.8	0.0	56.3	6	2.0	0.0
278	1407+96.706	1	91	58.8	54.2	0.0	58.0	6	2.0	0.0
279	1404+29.829	1	91	61.9	58.0	0.0	61.3	4	2.0	0.0
280	1400+62.951	1	91	62.0	59.0	0.0	61.5	4	2.0	0.0
281	1396+96.074	1	91	62.0	58.9	0.0	61.5	4	2.0	0.0
282	1393+29.197	1	91	62.2	58.0	0.0	61.5	6	2.0	0.0
283	1389+62.319	1	91	62.2	58.8	0.0	61.6	6	2.0	0.0
284	1385+95.442	1	91	62.3	59.0	0.0	61.8	6	2.0	1.0
285	1382+28.565	1	91	62.3	59.0	0.0	61.7	6	2.0	0.0
286	1378+61.687	1	91	62.3	59.0	0.0	61.7	6	2.0	0.0
287	1374+94.810	1	91	58.6	54.3	0.0	58.0	6	2.0	1.0
288	1371+27.932	1	91	58.1	53.7	0.0	57.3	9	2.1	0.0
289	1367+61.055	1	92	58.1	53.7	0.0	57.4	8	2.2	1.0
290	1363+94.178	1	92	57.9	53.7	0.0	57.2	9	2.1	0.0
291	1360+27.300	1	92	57.6	53.7	0.0	57.0	10	2.1	0.0
292	1356+60.423	1	92	59.5	55.3	0.0	58.8	13	2.1	0.0
293	1352+93.546	1	93	56.3	52.0	0.0	55.6	13	2.1	1.0
294	1349+26.668	1	93	58.3	52.9	0.0	57.4	14	2.1	0.0
295	1345+59.791	1	93	58.2	54.3	0.0	57.5	14	2.1	0.0
296	1341+92.913	1	93	57.4	53.7	0.0	56.8	12	2.0	0.0
297	1338+26.036	1	93	57.2	53.7	0.0	56.7	12	2.0	0.0
298	1334+59.159	1	93	59.8	54.9	0.0	59.0	13	2.0	0.0
299	1330+92.281	1	93	61.6	57.2	0.0	60.9	13	2.0	0.0
300	1327+25.404	1	93	61.8	58.3	0.0	61.3	13	2.0	0.0



*Interactive Highway Safety Design Model*

**Traffic Analysis Evaluation Report**

**P2\_6 Alignment Alternative**

January 5, 2018



## **Disclaimer**

The Interactive Highway Design Model (IHSDM) software is disseminated under the sponsorship of the Department of Transportation in the interest of information exchange. The United States Government assumes no liability for its content or use thereof. This document does not constitute a standard, specification, or regulation.

The United States Government does not endorse products or manufacturers. Trade and manufacturers' names may appear in this software and documentation only because they are considered essential to the objective of the software.

## **Limited Warranty and Limitations of Remedies**

This software product is provided "as-is," without warranty of any kind-either expressed or implied (but not limited to the implied warranties of merchantability and fitness for a particular purpose). The FHWA do not warrant that the functions contained in the software will meet the end-user's requirements or that the operation of the software will be uninterrupted and error-free.

Under no circumstances will the FHWA be liable to the end-user for any damages or claimed lost profits, lost savings, or other incidental or consequential damages rising out of the use or inability to use the software (even if these organizations have been advised of the possibility of such damages), or for any claim by any other party.

## **Notice**

The use of the IHSDM software is being done strictly on a voluntary basis. In exchange for provision of IHSDM, the user agrees that the Federal Highway Administration (FHWA), U.S. Department of Transportation and any other agency of the Federal Government shall not be responsible for any errors, damage or other liability that may result from any and all use of the software, including installation and testing of the software. The user further agrees to hold the FHWA and the Federal Government harmless from any resulting liability. The user agrees that this hold harmless provision shall flow to any person to whom or any entity to which the user provides the IHSDM software. It is the user's full responsibility to inform any person to whom or any entity to which it provides the IHSDM software of this hold harmless provision.

---

---

## Table of Contents

<b>Report Overview</b> .....	<b>1</b>
<b>Traffic Analysis Graphical Results</b> .....	<b>2</b>
<b>Simulation Input Data</b> .....	<b>7</b>
<b>Simulation Output Summary</b> .....	<b>9</b>
<b>Simulation Station Summaries</b> .....	<b>10</b>

## List of Tables

Table Simulation Parameters .....	7
Table Random Number Generator Seeds .....	7
Table Traffic Input Data .....	8
Table Section Summary .....	9
Table Station Summary (Increasing) .....	10
Table Station Summary (Decreasing) .....	16

## List of Figures

Figure Graphical Results (Increasing) .....	3
Figure Graphical Results (Decreasing) .....	5

## Report Overview

**Report Generated:** Jan 5, 2018 1:29 PM

**Report Template:** System: Multi-Page [System] (tam2, Oct 9, 2017 1:45 PM)

**Evaluation Date:** Fri Jan 05 13:28:11 AKST 2018

**IHSDM Version:** v13.0.0 (Sep 13, 2017)

**Traffic Analysis Module:** v1.6.0 (Mar 24, 2017)

**User Name:** RaeAnne Hebnes

**Organization Name:** Michael Baker International

**Phone:**

**E-Mail:**

**Project Title:** Parks 305 - 325 v2

**Project Comment:** Created using wizard

**Project Unit System:** U.S. Customary

**Highway Title:** Alignment P2\_6\_1dec2017

**Highway Comment:** Alignment P2\_1dec2017 with 6% max grade

**Highway Version:** 1

**Evaluation Title:** Evaluation 15

**Evaluation Comment:** Created Fri Jan 05 13:27:37 AKST 2018

**Minimum Station:** 0.000

**Maximum Station:** 2424+38.143(1)

**Configuration Name:** Default

## **Traffic Analysis Graphical Results**

[[Graphical Results in the Engineer's Manual](#)]

Figure 1 below displays the graphical results of the Traffic Analysis Module evaluation for the increasing direction of travel.

Traffic Analysis Summary, Increasing Direction of Travel  
 Project: Parks 305 - 325 v2, Evaluation: Evaluation 15  
 Highway: Alignment P2\_6\_1 dec2017

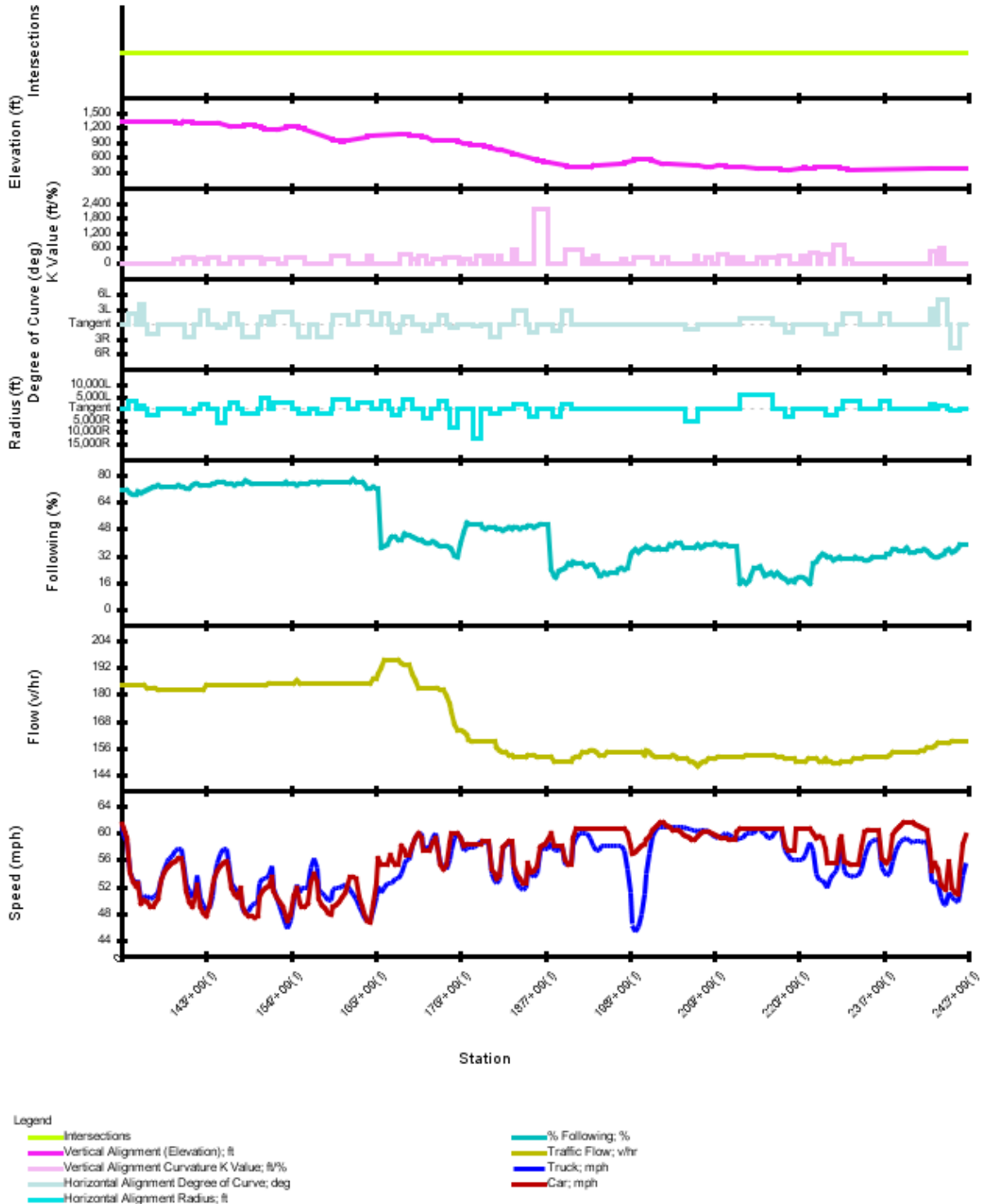

Figure 1. Graphical Results (Increasing)



Figure 2 below displays the graphical results of the Traffic Analysis Module evaluation for the decreasing direction of travel.

Traffic Analysis Summary, Decreasing Direction of Travel  
 Project: Parks 305 - 325 v2, Evaluation: Evaluation 15  
 Highway: Alignment P2\_6\_1 dec2017

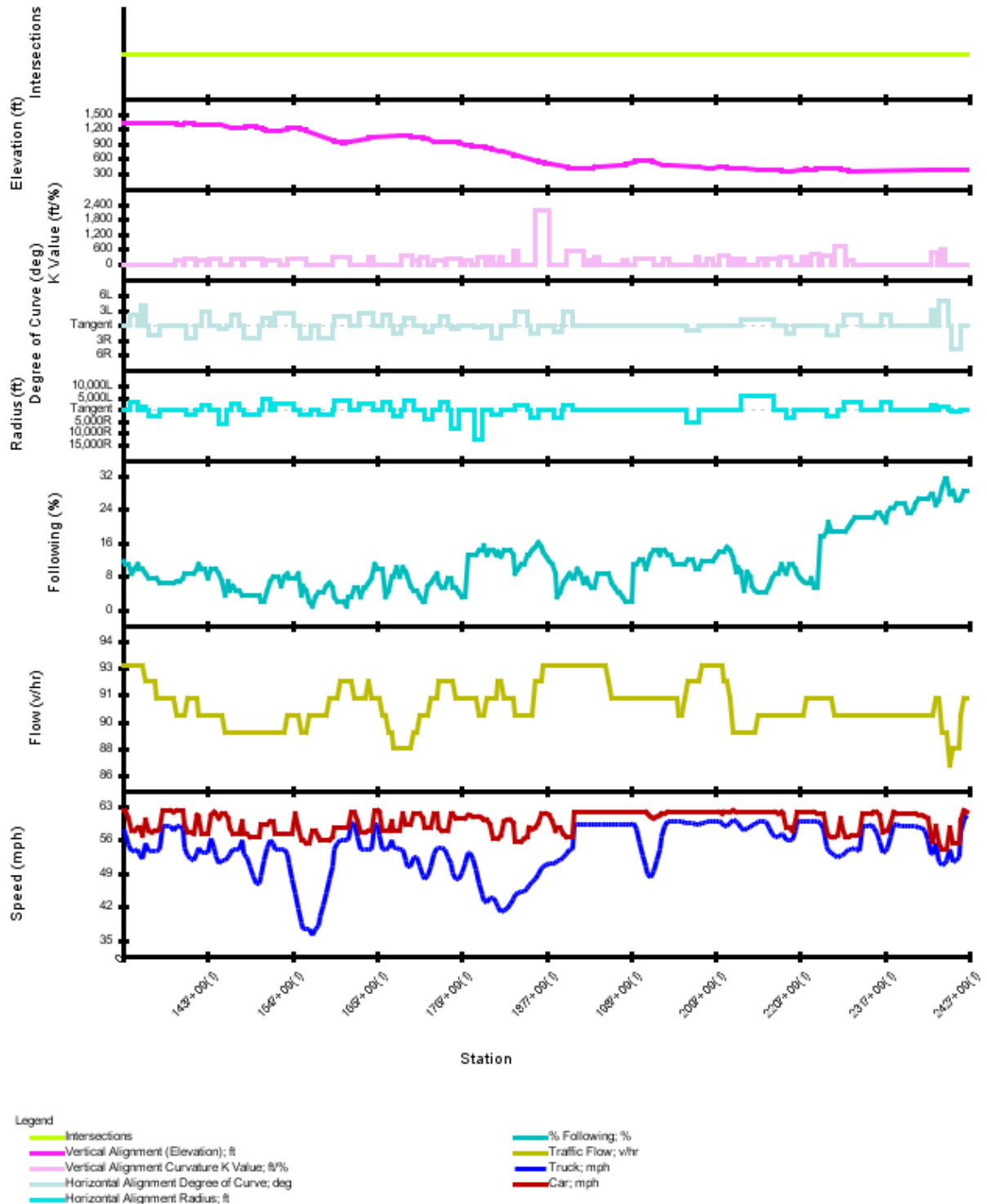

Figure 2. Graphical Results (Decreasing)



## Simulation Input Data

[Traffic Input Data in the Engineer's Manual]

**Table 1. Simulation Parameters**

Simulation Time (min)	60
Warm-up Time (min)	10
Total Time (min)	70
Computer Time (sec)	1
Test Road Length (mi)	20.7820

**Table 2. Random Number Generator Seeds**

Description	Value
Entering Traffic in Platoons / Direction of Increasing Stations	81250132
Desired Speed / Direction of Increasing Stations	70867724
Entering Traffic in Platoons / Direction of Decreasing Stations	33333334
Desired Speed / Direction of Decreasing Stations	16532240
Passing Decisions	52338126

**Table 3. Traffic Input Data**

Direction of Travel	Flow Rate (vph)	Distribution Cars (%)	Distribution Trucks (%)	Distribution RVs (%)	Mean Desired Speed Cars (mph)	Mean Desired Speed Trucks (mph)	Mean Desired Speed RVs (mph)	Desired Speed Standard Deviation Cars (mph)	Desired Speed Standard Deviation Trucks (mph)	Desired Speed Standard Deviation RVs (mph)	Entering Traffic in Platoons (%)	No Passing Zone (%)
Increasing	170	83	17	0	61.5	59.5	59.5	5.0	3.5	4.0	65	0
Decreasing	91	83	17	0	61.5	59.5	59.5	5.0	3.5	4.0	35	0

## Simulation Output Summary

[Section Summary in the Engineer's Manual]

Table 4 below includes the traffic output data table for the main road section. The table reports the actual simulated flow rate, percent time spent following, average speed, trip time, traffic delay, geometric delay, total delay, number of passes, vehicle-distance traveled, and vehicle-hours of travel. These simulation outputs are reported for each direction and both directions combined.

**Table 4. Section Summary**

Direction of Travel	Flow Rate from Simulation (vph)	Percent Time Spent Following (%)	Average Travel Speed (mph)	Trip Time (min/veh)	Traffic Delay (min/veh)	Geometric Delay (min/veh)	Total Delay (min/v eh)	Number of Passes	Distance Traveled (mi)	Total Travel Time (veh-hrs)
Increasing	167	50	55.0	22.5	1.0	0.9	1.9	509	3,442.6	62.6
Decreasing	91	11	58.3	21.4	-0.4	1.2	0.8	173	1,883.7	32.3
Combined	258	36	56.2	22.1	0.5	1.0	1.5	682	5,326.3	94.9

## Simulation Station Summaries

[Station Summary in the Engineer's Manual]

Table 5 below reports spot traffic operational data collected by the simulation at each data collection station for travel in direction of increasing stations. These data are analogous to data that would be collected by a traffic data recorder placed at the specified location on the highway during the simulation time. The data include hourly traffic volume; measured mean speed of cars, trucks, and recreational vehicles; mean and standard deviation speed for all vehicles combined; percent of vehicles following at a headway of less than 4 seconds; the average platoon size; and number of passes. A separate table is produced for each direction of travel. The data in this station summary data tables are used to create graphs.

**Table 5. Station Summary (Increasing)**

Station Number	Station	Number of Lanes	Traffic Volume (vpd)	Speed Mean Cars (mph)	Speed Mean Trucks (mph)	Speed Mean RVs (mph)	Speed Mean All (mph)	Percent Following (%)	Platoon Size	Number of Passes
1	1327+25.404(1)	1	184	61.4	61.0	0.0	61.4	71	5.5	0.0
2	1330+92.281(1)	1	184	60.7	59.5	0.0	60.5	71	5.5	0.0
3	1334+59.159(1)	1	184	59.3	58.7	0.0	59.3	71	5.5	0.0
4	1338+26.036(1)	1	184	54.2	54.2	0.0	54.2	69	4.6	0.0
5	1341+92.913(1)	1	184	52.8	52.9	0.0	52.8	68	4.6	0.0
6	1345+59.791(1)	1	184	52.0	52.2	0.0	52.0	68	4.6	0.0
7	1349+26.668(1)	1	184	52.6	52.9	0.0	52.7	70	5.0	0.0
8	1352+93.546(1)	1	184	49.4	50.2	0.0	49.5	70	4.9	0.0
9	1356+60.423(1)	1	184	49.9	50.3	0.0	50.0	70	4.9	0.0
10	1360+27.300(1)	1	183	49.7	50.6	0.0	49.8	71	4.9	0.0
11	1363+94.178(1)	1	183	49.1	50.1	0.0	49.2	72	5.3	0.0
12	1367+61.055(1)	1	183	49.1	50.3	0.0	49.3	73	5.4	0.0
13	1371+27.932(1)	1	183	49.4	50.6	0.0	49.6	73	5.6	0.0
14	1374+94.810(1)	1	182	50.1	51.0	0.0	50.3	74	5.6	0.0
15	1378+61.687(1)	1	182	53.0	52.9	0.0	53.0	73	5.4	0.0
16	1382+28.565(1)	1	182	54.1	54.6	0.0	54.2	73	5.4	0.0
17	1385+95.442(1)	1	182	54.8	55.8	0.0	55.0	73	5.4	0.0
18	1389+62.319(1)	1	182	55.0	56.3	0.0	55.2	73	5.4	0.0
19	1393+29.197(1)	1	182	55.4	56.5	0.0	55.6	73	5.4	0.0
20	1396+96.074(1)	1	182	55.8	57.4	0.0	56.0	73	5.4	0.0
21	1400+62.951(1)	1	182	56.1	57.7	0.0	56.3	74	5.6	0.0
22	1404+29.829(1)	1	182	56.1	57.5	0.0	56.3	73	5.4	0.0
23	1407+96.706(1)	1	182	55.1	56.0	0.0	55.2	73	5.4	0.0
24	1411+63.584(1)	1	182	51.4	52.6	0.0	51.5	72	5.3	0.0
25	1415+30.461(1)	1	182	49.8	51.4	0.0	50.0	72	5.3	0.0
26	1418+97.338(1)	1	182	48.9	50.5	0.0	49.1	74	5.7	0.0
27	1422+64.216(1)	1	182	50.7	51.8	0.0	50.8	75	5.9	0.0
28	1426+31.093(1)	1	182	52.2	53.7	0.0	52.4	75	5.9	0.0
29	1429+97.970(1)	1	182	49.0	50.3	0.0	49.2	74	5.5	0.0
30	1433+64.848(1)	1	182	48.0	49.3	0.0	48.1	74	5.5	0.0
31	1437+31.725(1)	1	184	47.5	48.5	0.0	47.6	74	5.5	0.0
32	1440+98.603(1)	1	184	49.3	48.8	0.0	49.2	74	5.5	0.0
33	1444+65.480(1)	1	184	52.0	50.6	0.0	51.8	74	5.7	0.0
34	1448+32.357(1)	1	184	53.3	53.0	0.0	53.3	75	5.9	0.0



Station Number	Station	Number of Lanes	Traffic Volume (vpd)	Speed Mean Cars (mph)	Speed Mean Trucks (mph)	Speed Mean RVs (mph)	Speed Mean All (mph)	Percent Following (%)	Platoon Size	Number of Passes
35	1451+99.235(1)	1	184	54.3	55.4	0.0	54.5	76	6.2	0.0
36	1455+66.112(1)	1	184	55.0	56.9	0.0	55.2	76	6.2	0.0
37	1459+32.989(1)	1	184	55.4	57.5	0.0	55.6	76	6.0	0.0
38	1462+99.867(1)	1	184	55.8	57.7	0.0	56.0	74	5.3	0.0
39	1466+66.744(1)	1	184	54.8	56.0	0.0	55.0	74	5.3	0.0
40	1470+33.622(1)	1	184	51.9	52.4	0.0	52.0	74	5.3	0.0
41	1474+00.499(1)	1	184	50.9	51.7	0.0	51.0	74	5.3	0.0
42	1477+67.376(1)	1	184	50.5	51.3	0.0	50.6	74	5.3	0.0
43	1481+34.254(1)	1	184	51.7	50.8	0.0	51.6	74	5.3	2.0
44	1485+01.131(1)	1	184	49.2	48.8	0.0	49.1	75	5.5	0.0
45	1488+68.008(1)	1	184	48.0	48.0	0.0	48.0	77	5.7	0.0
46	1492+34.886(1)	1	184	47.6	48.3	0.0	47.7	76	5.5	0.0
47	1496+01.763(1)	1	184	47.6	49.2	0.0	47.8	75	5.3	0.0
48	1499+68.641(1)	1	184	47.3	49.4	0.0	47.6	75	5.3	0.0
49	1503+35.518(1)	1	184	47.7	49.8	0.0	48.0	75	5.3	0.0
50	1507+02.395(1)	1	184	50.3	52.4	0.0	50.5	75	5.3	0.0
51	1510+69.273(1)	1	184	51.4	53.2	0.0	51.6	75	5.3	0.0
52	1514+36.150(1)	1	184	51.8	53.3	0.0	52.0	75	5.3	0.0
53	1518+03.027(1)	1	185	52.0	53.6	0.0	52.2	75	5.3	0.0
54	1521+69.905(1)	1	185	53.5	55.0	0.0	53.7	75	5.3	0.0
55	1525+36.782(1)	1	185	51.4	51.7	0.0	51.4	75	5.5	0.0
56	1529+03.660(1)	1	185	50.5	50.5	0.0	50.5	75	5.3	0.0
57	1532+70.537(1)	1	185	49.7	49.1	0.0	49.6	75	5.3	0.0
58	1536+37.414(1)	1	185	48.9	47.7	0.0	48.8	75	5.5	0.0
59	1540+04.292(1)	1	185	47.7	46.2	0.0	47.5	76	5.7	0.0
60	1543+71.169(1)	1	185	47.0	45.7	0.0	46.8	75	5.6	0.0
61	1547+38.046(1)	1	185	47.9	47.0	0.0	47.8	75	5.6	0.0
62	1551+04.924(1)	1	185	50.7	49.6	0.0	50.6	75	5.6	0.0
63	1554+71.801(1)	1	186	51.9	52.3	0.0	52.0	74	5.5	0.0
64	1558+38.679(1)	1	185	49.4	51.0	0.0	49.6	75	5.5	0.0
65	1562+05.556(1)	1	185	49.1	51.7	0.0	49.4	75	5.5	0.0
66	1565+72.433(1)	1	185	49.1	51.8	0.0	49.4	75	5.5	0.0
67	1569+39.311(1)	1	185	49.4	51.8	0.0	49.6	75	5.5	0.0
68	1573+06.188(1)	1	185	52.7	54.9	0.0	53.0	76	5.7	0.0
69	1576+73.065(1)	1	185	54.0	56.3	0.0	54.3	76	5.7	0.0
70	1580+39.943(1)	1	185	52.7	54.9	0.0	53.0	76	5.7	0.0
71	1584+06.820(1)	1	185	50.1	51.5	0.0	50.3	75	5.5	0.0
72	1587+73.698(1)	1	185	49.2	51.1	0.0	49.5	76	5.5	0.0
73	1591+40.575(1)	1	185	48.8	50.7	0.0	49.0	76	5.5	0.0
74	1595+07.452(1)	1	185	48.1	50.0	0.0	48.4	76	5.5	0.0
75	1598+74.330(1)	1	185	47.9	49.9	0.0	48.1	76	5.5	0.0
76	1602+41.207(1)	1	185	49.1	51.5	0.0	49.4	76	5.5	0.0
77	1606+08.084(1)	1	185	49.3	51.9	0.0	49.6	76	5.5	0.0
78	1609+74.962(1)	1	185	49.8	51.9	0.0	50.0	76	5.5	0.0
79	1613+41.839(1)	1	185	50.5	52.0	0.0	50.7	76	5.5	0.0
80	1617+08.716(1)	1	185	51.2	52.2	0.0	51.3	76	5.4	0.0
81	1620+75.594(1)	1	185	51.8	52.2	0.0	51.9	76	5.4	0.0
82	1624+42.471(1)	1	185	53.5	51.6	0.0	53.3	76	5.5	1.0
83	1628+09.349(1)	1	185	53.5	50.9	0.0	53.1	77	5.9	1.0
84	1631+76.226(1)	1	185	53.1	50.2	0.0	52.8	76	5.7	1.0

Station Number	Station	Number of Lanes	Traffic Volume (vpd)	Speed Mean Cars (mph)	Speed Mean Trucks (mph)	Speed Mean RVs (mph)	Speed Mean All (mph)	Percent Following (%)	Platoon Size	Number of Passes
85	1635+43.103(1)	1	185	50.3	48.9	0.0	50.1	76	5.5	0.0
86	1639+09.981(1)	1	185	49.1	48.0	0.0	49.0	76	5.7	0.0
87	1642+76.858(1)	1	185	48.1	47.3	0.0	48.0	75	5.3	0.0
88	1646+43.735(1)	1	185	47.0	46.8	0.0	47.0	72	4.9	0.0
89	1650+10.613(1)	1	185	46.7	46.8	0.0	46.7	72	4.9	0.0
90	1653+77.490(1)	1	187	49.4	48.5	0.0	49.3	73	5.0	0.0
91	1657+44.368(1)	1	187	52.6	50.3	0.0	52.3	72	4.8	0.0
92	1661+11.245(1)	1	189	56.2	52.0	0.0	55.6	72	5.0	0.0
93	1664+78.122(1)	2	192	55.2	51.1	0.0	54.5	36	2.9	0.0
94	1668+45.000(1)	2	195	55.2	51.8	0.0	55.2	37	3.0	6.0
95	1672+11.877(1)	2	195	55.2	52.5	0.0	55.2	38	2.8	18.0
96	1675+78.754(1)	2	195	56.6	52.5	0.0	55.9	43	2.8	16.0
97	1679+45.632(1)	2	195	55.9	52.5	0.0	55.2	43	2.8	14.0
98	1683+12.509(1)	2	195	55.2	53.2	0.0	55.2	44	2.7	11.0
99	1686+79.387(1)	2	195	55.2	53.2	0.0	55.2	42	2.7	13.0
100	1690+46.264(1)	2	194	58.0	53.9	0.0	57.3	42	2.8	13.0
101	1694+13.141(1)	2	193	57.3	55.2	0.0	56.6	45	2.9	12.0
102	1697+80.019(1)	2	193	56.6	55.9	0.0	56.6	44	2.9	9.0
103	1701+46.896(1)	2	193	56.6	55.9	0.0	56.6	44	3.0	13.0
104	1705+13.773(1)	2	189	58.0	58.0	0.0	58.0	43	2.9	8.0
105	1708+80.651(1)	2	186	59.3	59.3	0.0	59.3	42	2.9	6.0
106	1712+47.528(1)	2	183	60.0	60.0	0.0	60.0	41	3.1	7.0
107	1716+14.406(1)	2	183	59.3	60.0	0.0	59.3	42	3.2	6.0
108	1719+81.283(1)	2	183	57.3	57.3	0.0	57.3	40	3.2	7.0
109	1723+48.160(1)	2	183	57.3	58.0	0.0	57.3	39	3.3	7.0
110	1727+15.038(1)	2	183	57.3	57.3	0.0	57.3	40	3.1	8.0
111	1730+81.915(1)	2	183	58.6	59.3	0.0	58.6	40	3.1	9.0
112	1734+48.792(1)	2	183	59.3	60.0	0.0	59.3	40	3.1	4.0
113	1738+15.670(1)	2	183	58.0	58.6	0.0	58.0	38	2.8	11.0
114	1741+82.547(1)	2	182	55.2	55.2	0.0	55.2	37	2.8	9.0
115	1745+49.425(1)	2	182	54.5	55.2	0.0	54.5	37	2.9	8.0
116	1749+16.302(1)	2	179	55.2	54.5	0.0	55.2	37	3.0	10.0
117	1752+83.179(1)	2	176	58.6	55.9	0.0	58.6	37	2.9	3.0
118	1756+50.057(1)	2	172	60.0	57.3	0.0	59.3	36	3.0	9.0
119	1760+16.934(1)	2	167	60.0	59.3	0.0	60.0	32	2.8	5.0
120	1763+83.811(1)	2	164	60.0	60.0	0.0	60.0	31	2.8	6.0
121	1767+50.689(1)	2	164	59.3	59.3	0.0	59.3	40	3.0	4.0
122	1771+17.566(1)	2	163	58.0	57.3	0.0	58.0	46	3.3	8.0
123	1774+84.444(1)	1	162	58.2	57.6	0.0	58.1	51	3.7	2.0
124	1778+51.321(1)	1	160	58.2	57.9	0.0	58.2	51	3.7	0.0
125	1782+18.198(1)	1	159	58.3	57.8	0.0	58.2	51	3.7	0.0
126	1785+85.076(1)	1	159	58.3	57.9	0.0	58.2	51	3.7	0.0
127	1789+51.953(1)	1	159	58.4	58.2	0.0	58.4	51	3.7	0.0
128	1793+18.830(1)	1	159	58.4	58.7	0.0	58.4	50	3.7	0.0
129	1796+85.708(1)	1	159	58.7	58.7	0.0	58.7	49	3.8	0.0
130	1800+52.585(1)	1	159	58.8	58.6	0.0	58.7	48	3.6	0.0
131	1804+19.463(1)	1	159	58.8	58.5	0.0	58.7	49	3.6	0.0
132	1807+86.340(1)	1	159	54.5	53.8	0.0	54.3	49	3.6	0.0
133	1811+53.217(1)	1	159	53.8	52.8	0.0	53.7	49	3.4	0.0
134	1815+20.095(1)	1	156	53.3	52.6	0.0	53.2	48	3.3	0.0

Station Number	Station	Number of Lanes	Traffic Volume (vpd)	Speed Mean Cars (mph)	Speed Mean Trucks (mph)	Speed Mean RVs (mph)	Speed Mean All (mph)	Percent Following (%)	Platoon Size	Number of Passes
135	1818+86.972(1)	1	155	53.6	53.0	0.0	53.5	48	3.5	0.0
136	1822+53.849(1)	1	154	57.8	57.5	0.0	57.8	47	3.4	0.0
137	1826+20.727(1)	1	154	58.4	58.3	0.0	58.4	48	3.5	1.0
138	1829+87.604(1)	1	153	58.7	58.4	0.0	58.6	49	3.7	0.0
139	1833+54.482(1)	1	153	58.7	58.2	0.0	58.6	48	3.7	0.0
140	1837+21.359(1)	1	152	55.2	54.3	0.0	55.1	49	3.9	0.0
141	1840+88.236(1)	1	152	53.9	52.6	0.0	53.7	49	3.9	0.0
142	1844+55.114(1)	1	152	53.3	51.8	0.0	53.0	48	3.8	0.0
143	1848+21.991(1)	1	152	52.4	51.5	0.0	52.3	49	3.7	0.0
144	1851+88.868(1)	1	152	52.6	51.7	0.0	52.5	49	3.7	0.0
145	1855+55.746(1)	1	153	55.4	54.5	0.0	55.3	50	3.6	0.0
146	1859+22.623(1)	1	153	54.2	53.9	0.0	54.1	50	3.6	0.0
147	1862+89.500(1)	1	153	54.3	53.5	0.0	54.2	49	3.7	0.0
148	1866+56.378(1)	1	152	55.0	53.9	0.0	54.8	50	3.7	0.0
149	1870+23.255(1)	1	152	57.8	57.2	0.0	57.7	51	3.7	1.0
150	1873+90.133(1)	1	152	58.1	57.8	0.0	58.1	51	3.7	0.0
151	1877+57.010(1)	1	152	58.2	57.6	0.0	58.2	51	3.7	0.0
152	1881+23.887(1)	1	152	58.9	57.6	0.0	58.7	51	3.7	0.0
153	1884+90.765(1)	2	152	60.0	58.6	0.0	60.0	24	2.6	0.0
154	1888+57.642(1)	2	150	58.0	57.3	0.0	58.0	20	2.3	0.0
155	1892+24.519(1)	2	150	58.0	57.3	0.0	58.0	19	2.3	6.0
156	1895+91.397(1)	2	150	58.0	57.3	0.0	58.0	23	2.5	10.0
157	1899+58.274(1)	2	150	58.0	58.0	0.0	58.0	23	2.5	5.0
158	1903+25.152(1)	2	150	55.9	55.2	0.0	55.9	25	2.6	9.0
159	1906+92.029(1)	2	150	55.2	55.2	0.0	55.2	27	2.6	2.0
160	1910+58.906(1)	2	150	55.2	55.2	0.0	55.2	27	2.5	8.0
161	1914+25.784(1)	2	151	59.3	58.0	0.0	59.3	28	2.5	4.0
162	1917+92.661(1)	2	152	60.7	59.3	0.0	60.7	28	2.6	3.0
163	1921+59.538(1)	2	152	60.7	60.0	0.0	60.7	28	2.7	1.0
164	1925+26.416(1)	2	154	60.7	60.0	0.0	60.7	27	2.6	5.0
165	1928+93.293(1)	2	154	60.7	60.0	0.0	60.7	25	2.4	5.0
166	1932+60.171(1)	2	154	60.7	60.0	0.0	60.7	25	2.3	3.0
167	1936+27.048(1)	2	155	60.7	59.3	0.0	60.7	26	2.5	3.0
168	1939+93.925(1)	2	155	60.7	58.0	0.0	60.0	26	2.5	2.0
169	1943+60.803(1)	2	154	60.7	57.3	0.0	60.0	23	2.3	2.0
170	1947+27.680(1)	2	153	60.7	57.3	0.0	60.0	20	2.4	4.0
171	1950+94.557(1)	2	153	60.7	58.0	0.0	60.0	20	2.4	2.0
172	1954+61.435(1)	2	153	60.7	58.0	0.0	60.0	22	2.6	0.0
173	1958+28.312(1)	2	154	60.7	58.0	0.0	60.0	21	2.6	2.0
174	1961+95.190(1)	2	154	60.7	58.0	0.0	60.0	22	2.5	5.0
175	1965+62.067(1)	2	154	60.7	58.0	0.0	60.0	21	2.6	1.0
176	1969+28.944(1)	2	154	60.7	58.0	0.0	60.7	21	2.6	3.0
177	1972+95.822(1)	2	154	60.7	58.0	0.0	60.7	23	2.6	4.0
178	1976+62.699(1)	2	154	60.7	58.0	0.0	60.7	25	2.6	0.0
179	1980+29.576(1)	2	154	60.7	57.3	0.0	60.0	24	2.4	0.0
180	1983+96.454(1)	2	154	60.0	54.5	0.0	58.6	25	2.7	3.0
181	1987+63.331(1)	2	154	58.0	51.1	0.0	56.6	32	2.8	8.0
182	1991+30.209(1)	1	154	56.9	46.2	0.0	55.3	34	3.0	7.0
183	1994+97.086(1)	1	154	57.1	45.2	0.0	55.3	36	3.3	1.0
184	1998+63.963(1)	1	154	57.5	46.0	0.0	55.8	34	3.0	0.0

Station Number	Station	Number of Lanes	Traffic Volume (vpd)	Speed Mean Cars (mph)	Speed Mean Trucks (mph)	Speed Mean RVs (mph)	Speed Mean All (mph)	Percent Following (%)	Platoon Size	Number of Passes
185	2002+30.841(1)	1	154	58.0	47.9	0.0	56.5	36	3.2	0.0
186	2005+97.718(1)	1	153	58.4	50.8	0.0	57.3	37	3.1	0.0
187	2009+64.595(1)	1	155	58.9	53.9	0.0	58.2	37	2.9	0.0
188	2013+31.473(1)	1	154	59.5	56.8	0.0	59.1	37	3.0	0.0
189	2016+98.350(1)	1	153	60.3	59.5	0.0	60.1	36	3.0	0.0
190	2020+65.228(1)	1	152	60.8	60.5	0.0	60.8	36	3.1	1.0
191	2024+32.105(1)	1	152	61.3	60.8	0.0	61.2	37	3.1	3.0
192	2027+98.982(1)	1	152	61.6	60.8	0.0	61.5	36	3.1	2.0
193	2031+65.860(1)	1	152	61.6	60.8	0.0	61.4	36	3.0	4.0
194	2035+32.737(1)	1	152	61.2	60.8	0.0	61.1	36	3.0	1.0
195	2038+99.614(1)	1	152	60.8	60.8	0.0	60.8	38	3.1	2.0
196	2042+66.492(1)	1	153	60.5	60.8	0.0	60.5	38	3.1	2.0
197	2046+33.369(1)	1	152	60.5	60.8	0.0	60.5	40	3.1	1.0
198	2050+00.247(1)	1	151	60.3	60.8	0.0	60.3	40	3.3	1.0
199	2053+67.124(1)	1	151	60.1	60.8	0.0	60.1	39	3.3	0.0
200	2057+34.001(1)	1	151	59.8	60.8	0.0	59.9	37	3.1	0.0
201	2061+00.879(1)	1	151	59.5	60.7	0.0	59.7	36	3.0	0.0
202	2064+67.756(1)	1	150	59.2	60.6	0.0	59.4	37	3.0	0.0
203	2068+34.633(1)	1	150	58.9	60.5	0.0	59.1	37	3.0	0.0
204	2072+01.511(1)	1	149	59.0	60.3	0.0	59.3	37	3.0	0.0
205	2075+68.388(1)	1	148	59.4	60.2	0.0	59.5	38	3.0	0.0
206	2079+35.266(1)	1	149	59.9	60.3	0.0	59.9	37	3.0	0.0
207	2083+02.143(1)	1	150	60.1	60.5	0.0	60.1	37	3.0	2.0
208	2086+69.020(1)	1	150	60.2	60.5	0.0	60.2	39	3.0	5.0
209	2090+35.898(1)	1	151	60.1	60.1	0.0	60.1	38	2.9	2.0
210	2094+02.775(1)	1	151	59.9	59.7	0.0	59.9	38	2.9	1.0
211	2097+69.652(1)	1	151	59.6	59.5	0.0	59.6	39	3.0	0.0
212	2101+36.530(1)	1	152	59.4	59.3	0.0	59.3	38	2.9	1.0
213	2105+03.407(1)	1	152	59.3	59.5	0.0	59.3	38	3.0	0.0
214	2108+70.285(1)	1	152	59.3	59.8	0.0	59.4	38	2.9	0.0
215	2112+37.162(1)	1	152	59.2	59.9	0.0	59.3	38	2.9	0.0
216	2116+04.039(1)	1	152	59.0	59.8	0.0	59.2	38	3.0	0.0
217	2119+70.917(1)	1	152	59.0	59.5	0.0	59.0	38	3.0	0.0
218	2123+37.794(1)	1	152	59.1	59.1	0.0	59.1	38	3.0	0.0
219	2127+04.671(1)	1	152	60.2	59.0	0.0	60.0	38	3.1	0.0
220	2130+71.549(1)	2	152	60.7	59.3	0.0	60.7	15	2.2	0.0
221	2134+38.426(1)	2	152	60.7	59.3	0.0	60.7	17	2.3	1.0
222	2138+05.303(1)	2	153	60.7	60.0	0.0	60.7	16	2.3	5.0
223	2141+72.181(1)	2	153	60.7	60.0	0.0	60.7	18	2.4	6.0
224	2145+39.058(1)	2	153	60.7	60.0	0.0	60.7	20	2.4	5.0
225	2149+05.936(1)	2	153	60.7	60.0	0.0	60.7	25	2.4	2.0
226	2152+72.813(1)	2	153	60.7	60.7	0.0	60.7	25	2.4	2.0
227	2156+39.690(1)	2	153	60.7	60.7	0.0	60.7	26	2.5	3.0
228	2160+06.568(1)	2	153	60.7	60.0	0.0	60.7	22	2.5	5.0
229	2163+73.445(1)	2	153	60.7	60.0	0.0	60.7	20	2.3	2.0
230	2167+40.322(1)	2	153	60.7	59.3	0.0	60.7	21	2.3	2.0
231	2171+07.200(1)	2	153	60.7	59.3	0.0	60.7	22	2.3	5.0
232	2174+74.077(1)	2	153	60.7	60.0	0.0	60.7	20	2.3	1.0
233	2178+40.955(1)	2	152	60.7	60.7	0.0	60.7	22	2.5	3.0
234	2182+07.832(1)	2	152	60.7	60.7	0.0	60.7	20	2.5	2.0

Station Number	Station	Number of Lanes	Traffic Volume (vpd)	Speed Mean Cars (mph)	Speed Mean Trucks (mph)	Speed Mean RVs (mph)	Speed Mean All (mph)	Percent Following (%)	Platoon Size	Number of Passes
235	2185+74.709(1)	2	152	60.7	60.0	0.0	60.7	19	2.5	4.0
236	2189+41.587(1)	2	151	58.0	57.3	0.0	58.0	18	2.6	4.0
237	2193+08.464(1)	2	151	57.3	56.6	0.0	57.3	17	2.5	3.0
238	2196+75.341(1)	2	151	57.3	55.9	0.0	56.6	17	2.4	1.0
239	2200+42.219(1)	2	151	57.3	55.9	0.0	57.3	17	2.3	4.0
240	2204+09.096(1)	2	150	60.7	55.9	0.0	60.0	18	2.3	6.0
241	2207+75.974(1)	2	150	60.7	55.9	0.0	60.0	19	2.3	0.0
242	2211+42.851(1)	2	150	60.7	55.9	0.0	60.0	19	2.3	5.0
243	2215+09.728(1)	2	150	60.7	56.6	0.0	60.0	18	2.4	3.0
244	2218+76.606(1)	2	151	60.7	58.0	0.0	60.7	17	2.3	1.0
245	2222+43.483(1)	2	151	60.7	58.6	0.0	60.0	15	2.4	0.0
246	2226+10.360(1)	2	151	60.0	57.3	0.0	60.0	27	2.8	4.0
247	2229+77.238(1)	2	151	59.3	53.9	0.0	58.6	28	2.6	1.0
248	2233+44.115(1)	1	150	59.4	53.0	0.0	58.4	31	2.8	2.0
249	2237+10.993(1)	1	150	59.3	53.0	0.0	58.4	33	3.0	0.0
250	2240+77.870(1)	1	151	57.5	52.2	0.0	56.7	32	3.0	0.0
251	2244+44.747(1)	1	150	55.5	51.8	0.0	54.9	31	3.0	0.0
252	2248+11.625(1)	1	150	55.5	53.1	0.0	55.2	31	3.2	0.0
253	2251+78.502(1)	1	149	55.5	53.9	0.0	55.2	30	3.1	0.0
254	2255+45.379(1)	1	149	55.6	54.3	0.0	55.4	30	3.0	0.0
255	2259+12.257(1)	1	149	59.0	57.1	0.0	58.8	31	3.1	0.0
256	2262+79.134(1)	1	150	59.5	58.4	0.0	59.3	30	3.0	0.0
257	2266+46.012(1)	1	150	55.7	54.3	0.0	55.5	30	3.0	0.0
258	2270+12.889(1)	1	150	55.4	53.7	0.0	55.2	30	3.0	0.0
259	2273+79.766(1)	1	150	55.2	53.6	0.0	55.0	30	2.8	0.0
260	2277+46.644(1)	1	151	55.2	53.5	0.0	54.9	30	2.8	0.0
261	2281+13.521(1)	1	151	55.2	53.7	0.0	55.0	31	2.7	0.0
262	2284+80.398(1)	1	151	55.3	53.6	0.0	55.0	30	2.7	0.0
263	2288+47.276(1)	1	151	57.8	54.5	0.0	57.3	30	2.7	0.0
264	2292+14.153(1)	1	152	60.1	56.5	0.0	59.5	30	2.7	0.0
265	2295+81.031(1)	1	152	60.4	57.8	0.0	60.0	30	2.7	1.0
266	2299+47.908(1)	1	152	60.5	58.7	0.0	60.2	30	2.7	1.0
267	2303+14.785(1)	1	152	60.5	58.8	0.0	60.3	31	2.7	0.0
268	2306+81.663(1)	1	152	60.5	59.0	0.0	60.3	32	2.7	0.0
269	2310+48.540(1)	1	152	60.5	59.1	0.0	60.3	32	2.7	0.0
270	2314+15.417(1)	1	152	56.3	54.8	0.0	56.0	31	2.7	0.0
271	2317+82.295(1)	1	152	55.8	54.2	0.0	55.5	32	2.7	0.0
272	2321+49.172(1)	1	152	55.6	53.6	0.0	55.3	33	2.7	0.0
273	2325+16.050(1)	1	153	56.2	53.8	0.0	55.8	33	2.8	0.0
274	2328+82.927(1)	1	154	59.8	55.8	0.0	59.2	36	2.7	0.0
275	2332+49.804(1)	1	154	60.3	57.3	0.0	59.8	36	2.7	3.0
276	2336+16.682(1)	1	154	60.8	58.3	0.0	60.3	35	2.6	1.0
277	2339+83.559(1)	1	154	61.2	58.7	0.0	60.8	35	2.6	3.0
278	2343+50.436(1)	1	154	61.6	59.0	0.0	61.2	35	2.6	2.0
279	2347+17.314(1)	1	154	61.6	59.3	0.0	61.2	36	2.6	1.0
280	2350+84.191(1)	1	154	61.6	58.7	0.0	61.1	34	2.5	2.0
281	2354+51.069(1)	1	154	61.5	58.5	0.0	61.0	34	2.6	3.0
282	2358+17.946(1)	1	154	61.4	58.7	0.0	61.0	34	2.6	0.0
283	2361+84.823(1)	1	154	61.2	58.8	0.0	60.8	35	2.7	4.0
284	2365+51.701(1)	1	155	60.9	58.8	0.0	60.5	35	2.7	1.0

Station Number	Station	Number of Lanes	Traffic Volume (vpd)	Speed Mean Cars (mph)	Speed Mean Trucks (mph)	Speed Mean RVs (mph)	Speed Mean All (mph)	Percent Following (%)	Platoon Size	Number of Passes
285	2369+18.578(1)	1	155	60.6	58.5	0.0	60.3	36	2.8	0.0
286	2372+85.455(1)	1	156	60.4	58.7	0.0	60.1	35	2.8	0.0
287	2376+52.333(1)	1	156	57.3	55.6	0.0	57.0	33	2.7	0.0
288	2380+19.210(1)	1	156	54.4	52.8	0.0	54.1	32	2.8	0.0
289	2383+86.087(1)	1	157	55.6	52.8	0.0	55.2	31	2.8	0.0
290	2387+52.965(1)	1	158	54.5	52.5	0.0	54.3	32	2.7	0.0
291	2391+19.842(1)	1	158	52.2	50.3	0.0	51.8	32	2.9	0.0
292	2394+86.720(1)	1	158	51.8	49.2	0.0	51.4	33	2.9	0.0
293	2398+53.597(1)	1	158	51.6	49.2	0.0	51.2	35	3.1	0.0
294	2402+20.474(1)	1	158	55.7	51.0	0.0	55.0	35	3.1	0.0
295	2405+87.352(1)	1	159	51.7	50.5	0.0	51.5	34	3.2	0.0
296	2409+54.229(1)	1	159	51.2	50.0	0.0	51.0	35	3.1	0.0
297	2413+21.106(1)	1	159	50.9	49.8	0.0	50.7	36	3.1	0.0
298	2416+87.984(1)	1	159	54.1	50.9	0.0	53.6	39	3.2	0.0
299	2420+54.861(1)	1	159	58.3	53.6	0.0	57.5	39	3.2	0.0
300	2424+21.739(1)	1	159	59.8	55.6	0.0	59.1	39	3.2	0.0

Table 6 below reports spot traffic operational data collected by the simulation at each data collection station for travel in direction of decreasing stations. These data are analogous to data that would be collected by a traffic data recorder placed at the specified location on the highway during the simulation time. The data include hourly traffic volume; measured mean speed of cars, trucks, and recreational vehicles; mean and standard deviation speed for all vehicles combined; percent of vehicles following at a headway of less than 4 seconds; the average platoon size; and number of passes. A separate table is produced for each direction of travel. The data in this station summary data tables are used to create graphs.

**Table 6. Station Summary (Decreasing)**

Station Number	Station	Number of Lanes	Traffic Volume (vpd)	Speed Mean Cars (mph)	Speed Mean Trucks (mph)	Speed Mean RVs (mph)	Speed Mean All (mph)	Percent Following (%)	Platoon Size	Number of Passes
1	2424+21.739(1)	1	91	61.9	61.1	0.0	61.8	29	2.9	0.0
2	2420+54.861(1)	1	91	62.3	60.1	0.0	62.0	29	2.9	0.0
3	2416+87.984(1)	1	90	60.3	57.5	0.0	59.9	27	2.6	0.0
4	2413+21.106(1)	1	88	55.2	52.3	0.0	54.7	26	2.6	1.0
5	2409+54.229(1)	1	88	55.2	51.9	0.0	54.6	26	2.6	2.0
6	2405+87.352(1)	1	88	55.2	51.5	0.0	54.6	28	2.6	5.0
7	2402+20.474(1)	1	87	58.6	53.9	0.0	57.8	28	2.6	1.0
8	2398+53.597(1)	1	89	54.2	51.8	0.0	53.8	32	2.9	0.0
9	2394+86.720(1)	1	89	53.9	51.0	0.0	53.5	32	2.8	1.0
10	2391+19.842(1)	1	89	53.9	50.7	0.0	53.4	29	2.6	0.0
11	2387+52.965(1)	1	91	55.2	51.4	0.0	54.7	26	2.6	4.0
12	2383+86.087(1)	1	91	58.9	55.3	0.0	58.4	25	2.5	0.0
13	2380+19.210(1)	1	90	55.8	53.0	0.0	55.4	28	2.7	1.0
14	2376+52.333(1)	1	90	56.7	53.0	0.0	56.1	28	2.7	1.0
15	2372+85.455(1)	1	90	60.7	56.0	0.0	60.0	27	2.7	0.0
16	2369+18.578(1)	1	90	61.0	57.9	0.0	60.6	27	2.7	0.0

Station Number	Station	Number of Lanes	Traffic Volume (vpd)	Speed Mean Cars (mph)	Speed Mean Trucks (mph)	Speed Mean RVs (mph)	Speed Mean All (mph)	Percent Following (%)	Platoon Size	Number of Passes
17	2365+51.701(1)	1	90	61.1	58.6	0.0	60.8	27	2.7	0.0
18	2361+84.823(1)	1	90	61.2	58.6	0.0	60.8	27	2.7	0.0
19	2358+17.946(1)	1	90	61.4	58.8	0.0	61.0	26	2.6	0.0
20	2354+51.069(1)	1	90	61.4	58.9	0.0	61.1	24	2.6	1.0
21	2350+84.191(1)	1	90	61.4	59.0	0.0	61.1	23	2.5	0.0
22	2347+17.314(1)	1	90	61.4	59.0	0.0	61.0	23	2.5	1.0
23	2343+50.436(1)	1	90	61.4	58.8	0.0	61.0	26	2.6	0.0
24	2339+83.559(1)	1	90	61.4	58.9	0.0	61.1	26	2.6	1.0
25	2336+16.682(1)	1	90	61.5	59.0	0.0	61.2	26	2.6	0.0
26	2332+49.804(1)	1	90	61.6	59.2	0.0	61.2	26	2.6	0.0
27	2328+82.927(1)	1	90	61.7	59.2	0.0	61.3	24	2.6	0.0
28	2325+16.050(1)	1	90	59.6	56.7	0.0	59.2	24	2.6	3.0
29	2321+49.172(1)	1	90	58.0	54.3	0.0	57.5	23	2.6	1.0
30	2317+82.295(1)	1	90	57.8	53.8	0.0	57.2	21	2.6	2.0
31	2314+15.417(1)	1	90	57.6	53.4	0.0	57.0	22	2.5	2.0
32	2310+48.540(1)	1	90	61.2	55.8	0.0	60.4	23	2.5	1.0
33	2306+81.663(1)	1	90	61.8	57.7	0.0	61.2	23	2.3	0.0
34	2303+14.785(1)	1	90	61.7	58.6	0.0	61.3	22	2.3	0.0
35	2299+47.908(1)	1	90	61.6	59.3	0.0	61.3	22	2.3	1.0
36	2295+81.031(1)	1	90	61.4	58.9	0.0	61.1	22	2.3	0.0
37	2292+14.153(1)	1	90	61.4	59.0	0.0	61.1	22	2.3	0.0
38	2288+47.276(1)	1	90	61.5	59.0	0.0	61.2	22	2.3	0.0
39	2284+80.398(1)	1	90	57.4	53.7	0.0	56.9	22	2.4	2.0
40	2281+13.521(1)	1	90	57.0	53.9	0.0	56.5	22	2.4	1.0
41	2277+46.644(1)	1	90	56.9	54.4	0.0	56.5	22	2.4	1.0
42	2273+79.766(1)	1	90	56.9	54.2	0.0	56.5	21	2.5	0.0
43	2270+12.889(1)	1	90	56.8	54.1	0.0	56.4	20	2.4	1.0
44	2266+46.012(1)	1	90	56.7	53.3	0.0	56.2	19	2.3	0.0
45	2262+79.134(1)	1	90	58.6	52.7	0.0	57.8	19	2.4	0.0
46	2259+12.257(1)	1	90	60.7	52.8	0.0	59.7	19	2.4	1.0
47	2255+45.379(1)	1	90	56.9	52.5	0.0	56.3	19	2.4	0.0
48	2251+78.502(1)	1	90	56.6	52.8	0.0	56.1	19	2.4	1.0
49	2248+11.625(1)	1	91	56.7	53.3	0.0	56.3	19	2.4	0.0
50	2244+44.747(1)	1	91	56.9	53.8	0.0	56.5	21	2.5	1.0
51	2240+77.870(1)	1	91	57.9	54.7	0.0	57.5	19	2.4	1.0
52	2237+10.993(1)	1	91	61.4	58.2	0.0	61.0	18	2.5	0.0
53	2233+44.115(1)	1	91	61.4	59.7	0.0	61.2	18	2.5	0.0
54	2229+77.238(1)	2	91	61.4	60.0	0.0	61.4	6	2.3	0.0
55	2226+10.360(1)	2	91	62.0	60.0	0.0	61.4	6	2.0	0.0
56	2222+43.483(1)	2	91	62.0	60.0	0.0	61.4	8	2.0	0.0
57	2218+76.606(1)	2	91	62.0	60.0	0.0	61.4	7	2.2	2.0
58	2215+09.728(1)	2	91	62.0	60.0	0.0	61.4	7	2.0	3.0
59	2211+42.851(1)	2	90	62.0	60.0	0.0	61.4	7	2.0	1.0
60	2207+75.974(1)	2	90	62.0	60.0	0.0	61.4	8	2.2	3.0
61	2204+09.096(1)	2	90	62.0	60.0	0.0	61.4	9	2.3	1.0
62	2200+42.219(1)	2	90	60.0	58.0	0.0	60.0	10	2.1	0.0
63	2196+75.341(1)	2	90	58.0	55.9	0.0	58.0	11	2.1	1.0
64	2193+08.464(1)	2	90	58.6	55.9	0.0	58.0	11	2.1	0.0
65	2189+41.587(1)	2	90	58.6	55.9	0.0	58.0	9	2.1	1.0
66	2185+74.709(1)	2	90	61.4	57.3	0.0	61.4	10	2.0	2.0



Station Number	Station	Number of Lanes	Traffic Volume (vpd)	Speed Mean Cars (mph)	Speed Mean Trucks (mph)	Speed Mean RVs (mph)	Speed Mean All (mph)	Percent Following (%)	Platoon Size	Number of Passes
67	2182+07.832(1)	2	90	62.0	57.3	0.0	61.4	11	2.0	0.0
68	2178+40.955(1)	2	90	61.4	56.6	0.0	60.7	9	2.0	1.0
69	2174+74.077(1)	2	90	62.0	56.6	0.0	61.4	9	2.0	0.0
70	2171+07.200(1)	2	90	62.0	57.3	0.0	61.4	8	2.0	0.0
71	2167+40.322(1)	2	90	62.0	58.6	0.0	61.4	6	2.0	1.0
72	2163+73.445(1)	2	90	62.0	60.0	0.0	61.4	4	2.0	0.0
73	2160+06.568(1)	2	90	62.0	60.0	0.0	61.4	4	2.0	0.0
74	2156+39.690(1)	2	90	62.0	60.0	0.0	61.4	4	2.0	0.0
75	2152+72.813(1)	2	90	62.0	60.0	0.0	61.4	4	2.0	2.0
76	2149+05.936(1)	2	89	62.0	59.3	0.0	61.4	4	2.3	1.0
77	2145+39.058(1)	2	89	62.0	59.3	0.0	61.4	6	2.3	0.0
78	2141+72.181(1)	2	89	62.0	58.6	0.0	61.4	8	2.2	1.0
79	2138+05.303(1)	2	89	62.0	58.6	0.0	61.4	9	2.1	0.0
80	2134+38.426(1)	2	89	62.0	58.0	0.0	61.4	4	2.3	0.0
81	2130+71.549(1)	2	89	62.0	58.6	0.0	61.4	9	2.6	0.0
82	2127+04.671(1)	1	89	62.0	59.6	0.0	61.6	10	2.5	0.0
83	2123+37.794(1)	1	89	61.9	59.9	0.0	61.6	9	2.6	0.0
84	2119+70.917(1)	1	89	62.1	60.1	0.0	61.8	12	2.4	0.0
85	2116+04.039(1)	1	91	62.0	59.5	0.0	61.7	14	2.3	0.0
86	2112+37.162(1)	1	92	61.9	59.0	0.0	61.5	15	2.4	2.0
87	2108+70.285(1)	1	92	61.7	59.0	0.0	61.3	14	2.3	1.0
88	2105+03.407(1)	1	93	61.6	59.5	0.0	61.4	14	2.3	0.0
89	2101+36.530(1)	1	93	61.8	59.9	0.0	61.5	14	2.3	1.0
90	2097+69.652(1)	1	93	61.8	59.9	0.0	61.6	13	2.2	0.0
91	2094+02.775(1)	1	93	61.9	59.9	0.0	61.6	12	2.1	0.0
92	2090+35.898(1)	1	93	62.0	59.9	0.0	61.7	12	2.1	2.0
93	2086+69.020(1)	1	93	61.9	59.9	0.0	61.6	12	2.1	0.0
94	2083+02.143(1)	1	93	61.8	59.7	0.0	61.5	12	2.1	0.0
95	2079+35.266(1)	1	93	61.7	59.5	0.0	61.4	12	2.1	0.0
96	2075+68.388(1)	1	92	61.7	59.2	0.0	61.4	10	2.1	0.0
97	2072+01.511(1)	1	92	61.8	59.3	0.0	61.4	10	2.1	0.0
98	2068+34.633(1)	1	92	61.8	59.5	0.0	61.5	12	2.1	0.0
99	2064+67.756(1)	1	92	61.8	59.7	0.0	61.5	12	2.1	0.0
100	2061+00.879(1)	1	92	61.8	59.7	0.0	61.6	12	2.1	0.0
101	2057+34.001(1)	1	91	61.9	59.7	0.0	61.6	11	2.1	2.0
102	2053+67.124(1)	1	90	61.9	59.8	0.0	61.6	11	2.1	0.0
103	2050+00.247(1)	1	90	62.0	59.9	0.0	61.6	11	2.1	0.0
104	2046+33.369(1)	1	91	61.9	59.9	0.0	61.6	11	2.1	1.0
105	2042+66.492(1)	1	91	61.9	59.9	0.0	61.6	11	2.1	0.0
106	2038+99.614(1)	1	91	61.8	59.9	0.0	61.6	13	2.1	0.0
107	2035+32.737(1)	1	91	61.8	59.8	0.0	61.5	13	2.1	0.0
108	2031+65.860(1)	1	91	61.6	58.8	0.0	61.2	14	2.1	0.0
109	2027+98.982(1)	1	91	61.5	56.7	0.0	60.8	14	2.1	0.0
110	2024+32.105(1)	1	91	61.2	54.1	0.0	60.1	13	2.1	2.0
111	2020+65.228(1)	1	91	60.8	51.7	0.0	59.5	14	2.1	0.0
112	2016+98.350(1)	1	91	60.5	49.5	0.0	58.9	14	2.1	0.0
113	2013+31.473(1)	1	91	60.9	48.2	0.0	59.1	13	2.1	1.0
114	2009+64.595(1)	1	91	61.4	48.7	0.0	59.6	11	2.1	0.0
115	2005+97.718(1)	1	91	61.7	50.4	0.0	60.1	10	2.1	0.0
116	2002+30.841(1)	1	91	61.8	52.6	0.0	60.5	12	2.1	1.0

Station Number	Station	Number of Lanes	Traffic Volume (vpd)	Speed Mean Cars (mph)	Speed Mean Trucks (mph)	Speed Mean RVs (mph)	Speed Mean All (mph)	Percent Following (%)	Platoon Size	Number of Passes
117	1998+63.963(1)	1	91	61.8	55.5	0.0	60.9	12	2.1	0.0
118	1994+97.086(1)	1	91	61.8	58.4	0.0	61.3	11	2.1	0.0
119	1991+30.209(1)	1	91	62.0	59.5	0.0	61.6	11	2.1	0.0
120	1987+63.331(1)	2	91	62.0	59.3	0.0	61.4	2	2.0	0.0
121	1983+96.454(1)	2	91	62.0	59.3	0.0	61.4	2	2.0	0.0
122	1980+29.576(1)	2	91	62.0	59.3	0.0	61.4	2	2.0	0.0
123	1976+62.699(1)	2	91	62.0	59.3	0.0	61.4	3	2.0	2.0
124	1972+95.822(1)	2	91	62.0	59.3	0.0	61.4	4	2.0	0.0
125	1969+28.944(1)	2	91	62.0	59.3	0.0	61.4	4	2.0	1.0
126	1965+62.067(1)	2	91	62.0	59.3	0.0	61.4	6	2.0	2.0
127	1961+95.190(1)	2	91	62.0	59.3	0.0	61.4	7	2.0	1.0
128	1958+28.312(1)	2	92	62.0	59.3	0.0	61.4	9	2.1	1.0
129	1954+61.435(1)	2	93	62.0	59.3	0.0	61.4	9	2.1	1.0
130	1950+94.557(1)	2	93	62.0	59.3	0.0	61.4	9	2.1	0.0
131	1947+27.680(1)	2	93	62.0	59.3	0.0	61.4	9	2.1	0.0
132	1943+60.803(1)	2	93	62.0	59.3	0.0	61.4	9	2.1	0.0
133	1939+93.925(1)	2	93	62.0	59.3	0.0	61.4	5	2.0	0.0
134	1936+27.048(1)	2	93	62.0	59.3	0.0	61.4	5	2.0	1.0
135	1932+60.171(1)	2	93	62.0	59.3	0.0	61.4	6	2.0	1.0
136	1928+93.293(1)	2	93	62.0	59.3	0.0	61.4	8	2.0	1.0
137	1925+26.416(1)	2	93	62.0	59.3	0.0	61.4	6	2.0	0.0
138	1921+59.538(1)	2	93	62.0	59.3	0.0	61.4	9	2.0	2.0
139	1917+92.661(1)	2	93	62.0	59.3	0.0	61.4	10	2.0	0.0
140	1914+25.784(1)	2	93	62.0	59.3	0.0	61.4	8	2.0	1.0
141	1910+58.906(1)	2	93	56.6	53.9	0.0	56.6	8	2.0	1.0
142	1906+92.029(1)	2	93	56.6	53.9	0.0	56.6	9	2.1	0.0
143	1903+25.152(1)	2	93	56.6	53.2	0.0	55.9	8	2.0	1.0
144	1899+58.274(1)	2	93	57.3	52.5	0.0	56.6	6	2.0	0.0
145	1895+91.397(1)	2	93	58.6	51.8	0.0	58.0	4	2.0	0.0
146	1892+24.519(1)	2	93	58.6	51.8	0.0	58.0	3	2.0	1.0
147	1888+57.642(1)	2	93	58.0	51.1	0.0	57.3	9	2.0	1.0
148	1884+90.765(1)	2	93	60.0	51.1	0.0	58.6	11	2.0	0.0
149	1881+23.887(1)	1	93	61.3	51.1	0.0	59.9	12	2.2	0.0
150	1877+57.010(1)	1	93	61.4	50.9	0.0	59.9	13	2.2	0.0
151	1873+90.133(1)	1	93	61.4	50.5	0.0	59.9	14	2.4	1.0
152	1870+23.255(1)	1	92	61.4	50.0	0.0	59.8	15	2.4	0.0
153	1866+56.378(1)	1	92	59.5	48.9	0.0	58.0	16	2.4	2.0
154	1862+89.500(1)	1	92	58.6	47.9	0.0	57.1	15	2.2	0.0
155	1859+22.623(1)	1	90	58.4	47.3	0.0	56.7	14	2.1	2.0
156	1855+55.746(1)	1	90	58.6	46.7	0.0	56.9	13	2.1	0.0
157	1851+88.868(1)	1	90	56.8	45.9	0.0	55.2	13	2.1	1.0
158	1848+21.991(1)	1	90	56.3	45.3	0.0	54.7	11	2.1	0.0
159	1844+55.114(1)	1	90	55.8	45.1	0.0	54.3	11	2.1	1.0
160	1840+88.236(1)	1	90	55.6	44.9	0.0	54.1	10	2.1	1.0
161	1837+21.359(1)	1	90	55.8	44.5	0.0	54.1	9	2.0	0.0
162	1833+54.482(1)	1	91	59.5	43.6	0.0	57.3	13	2.1	0.0
163	1829+87.604(1)	1	91	60.1	42.5	0.0	57.5	14	2.1	1.0
164	1826+20.727(1)	1	91	60.1	41.8	0.0	57.5	14	2.1	4.0
165	1822+53.849(1)	1	91	59.9	41.3	0.0	57.2	14	2.1	0.0
166	1818+86.972(1)	1	92	56.9	41.0	0.0	54.6	13	2.1	0.0

Station Number	Station	Number of Lanes	Traffic Volume (vpd)	Speed Mean Cars (mph)	Speed Mean Trucks (mph)	Speed Mean RVs (mph)	Speed Mean All (mph)	Percent Following (%)	Platoon Size	Number of Passes
167	1815+20.095(1)	1	92	56.2	42.0	0.0	54.2	14	2.1	1.0
168	1811+53.217(1)	1	91	56.4	43.0	0.0	54.5	13	2.1	0.0
169	1807+86.340(1)	1	91	56.3	43.8	0.0	54.5	14	2.1	1.0
170	1804+19.463(1)	1	91	59.4	43.8	0.0	57.1	14	2.1	1.0
171	1800+52.585(1)	1	91	60.1	43.0	0.0	57.6	13	2.1	1.0
172	1796+85.708(1)	1	90	60.1	43.4	0.0	58.0	16	2.2	0.0
173	1793+18.830(1)	1	90	60.6	44.6	0.0	58.5	14	2.2	0.0
174	1789+51.953(1)	1	90	60.8	46.9	0.0	59.0	14	2.2	0.0
175	1785+85.076(1)	1	91	61.0	49.8	0.0	59.5	13	2.1	1.0
176	1782+18.198(1)	1	91	61.0	52.0	0.0	59.9	13	2.1	0.0
177	1778+51.321(1)	1	91	61.2	53.5	0.0	60.1	13	2.1	0.0
178	1774+84.444(1)	1	91	61.3	53.5	0.0	60.3	13	2.1	0.0
179	1771+17.566(1)	2	91	60.7	51.1	0.0	59.3	3	2.0	0.0
180	1767+50.689(1)	2	91	60.7	49.1	0.0	59.3	3	2.0	1.0
181	1763+83.811(1)	2	91	60.7	47.7	0.0	58.6	4	2.0	2.0
182	1760+16.934(1)	2	91	60.7	47.7	0.0	59.3	6	2.0	2.0
183	1756+50.057(1)	2	92	61.4	49.1	0.0	59.3	5	2.0	2.0
184	1752+83.179(1)	2	92	61.4	51.1	0.0	60.0	8	2.0	0.0
185	1749+16.302(1)	2	92	58.0	52.5	0.0	57.3	8	2.0	1.0
186	1745+49.425(1)	2	92	58.0	53.9	0.0	57.3	5	2.0	1.0
187	1741+82.547(1)	2	92	58.0	54.5	0.0	57.3	5	2.0	0.0
188	1738+15.670(1)	2	92	58.6	54.5	0.0	58.0	6	2.0	2.0
189	1734+48.792(1)	2	91	61.4	54.5	0.0	60.7	9	2.0	1.0
190	1730+81.915(1)	2	91	61.4	53.2	0.0	60.0	8	2.0	1.0
191	1727+15.038(1)	2	91	58.6	50.5	0.0	58.0	7	2.0	1.0
192	1723+48.160(1)	2	90	58.6	48.4	0.0	57.3	6	2.0	0.0
193	1719+81.283(1)	2	90	58.6	47.7	0.0	57.3	2	2.0	0.0
194	1716+14.406(1)	2	90	60.7	48.4	0.0	59.3	2	2.0	0.0
195	1712+47.528(1)	2	90	61.4	50.5	0.0	60.0	3	2.0	2.0
196	1708+80.651(1)	2	89	61.4	52.5	0.0	60.0	4	2.0	0.0
197	1705+13.773(1)	2	89	61.4	52.5	0.0	60.7	4	2.0	1.0
198	1701+46.896(1)	2	88	59.3	50.5	0.0	58.0	6	2.0	1.0
199	1697+80.019(1)	2	88	59.3	50.5	0.0	58.0	8	2.0	0.0
200	1694+13.141(1)	2	88	59.3	51.8	0.0	58.0	9	2.1	0.0
201	1690+46.264(1)	2	88	61.4	53.9	0.0	60.7	10	2.1	0.0
202	1686+79.387(1)	2	88	58.0	53.9	0.0	57.3	8	2.0	1.0
203	1683+12.509(1)	2	88	58.0	54.5	0.0	57.3	10	2.0	0.0
204	1679+45.632(1)	2	88	58.0	54.5	0.0	57.3	8	2.0	1.0
205	1675+78.754(1)	2	89	60.0	55.9	0.0	59.3	8	2.0	2.0
206	1672+11.877(1)	2	89	58.0	54.5	0.0	57.3	4	2.0	0.0
207	1668+45.000(1)	2	90	58.0	53.9	0.0	57.3	3	2.0	1.0
208	1664+78.122(1)	2	90	58.0	53.9	0.0	57.3	10	2.0	1.0
209	1661+11.245(1)	1	91	61.9	57.1	0.0	61.2	10	2.0	0.0
210	1657+44.368(1)	1	91	62.3	59.1	0.0	61.8	10	2.0	0.0
211	1653+77.490(1)	1	91	62.2	59.4	0.0	61.8	11	2.0	0.0
212	1650+10.613(1)	1	91	57.8	54.2	0.0	57.3	8	2.0	1.0
213	1646+43.735(1)	1	92	57.8	54.2	0.0	57.3	6	2.0	0.0
214	1642+76.858(1)	1	91	57.5	54.2	0.0	57.1	6	2.0	0.0
215	1639+09.981(1)	1	91	57.5	54.2	0.0	57.0	6	2.0	0.0
216	1635+43.103(1)	1	91	57.5	54.2	0.0	57.0	3	2.0	0.0

Station Number	Station	Number of Lanes	Traffic Volume (vpd)	Speed Mean Cars (mph)	Speed Mean Trucks (mph)	Speed Mean RVs (mph)	Speed Mean All (mph)	Percent Following (%)	Platoon Size	Number of Passes
217	1631+76.226(1)	1	91	60.0	56.8	0.0	59.5	6	2.0	0.0
218	1628+09.349(1)	1	91	62.0	59.6	0.0	61.6	6	2.0	0.0
219	1624+42.471(1)	2	92	62.0	59.3	0.0	61.4	3	2.0	0.0
220	1620+75.594(1)	2	92	58.6	55.9	0.0	58.6	3	2.0	0.0
221	1617+08.716(1)	2	92	58.6	55.9	0.0	58.6	1	2.0	0.0
222	1613+41.839(1)	2	92	58.6	55.9	0.0	58.6	2	2.0	0.0
223	1609+74.962(1)	2	92	58.6	55.9	0.0	58.6	2	2.0	2.0
224	1606+08.084(1)	2	91	58.6	55.2	0.0	58.0	2	2.0	0.0
225	1602+41.207(1)	2	91	58.6	53.9	0.0	58.0	3	2.0	2.0
226	1598+74.330(1)	2	91	56.6	50.5	0.0	55.9	6	2.0	1.0
227	1595+07.452(1)	2	91	55.9	47.7	0.0	54.5	7	2.0	1.0
228	1591+40.575(1)	2	90	55.9	45.0	0.0	54.5	6	2.0	0.0
229	1587+73.698(1)	2	90	55.9	42.3	0.0	53.9	4	2.0	0.0
230	1584+06.820(1)	2	90	55.9	40.2	0.0	53.2	4	2.0	0.0
231	1580+39.943(1)	2	90	56.6	38.2	0.0	53.9	4	2.0	0.0
232	1576+73.065(1)	2	90	58.0	37.5	0.0	54.5	3	2.0	2.0
233	1573+06.188(1)	2	90	58.0	36.1	0.0	55.2	1	2.0	2.0
234	1569+39.311(1)	2	90	55.2	37.5	0.0	52.5	2	2.0	0.0
235	1565+72.433(1)	2	89	55.2	37.5	0.0	52.5	4	2.0	2.0
236	1562+05.556(1)	2	89	55.9	37.5	0.0	52.5	6	2.0	1.0
237	1558+38.679(1)	2	89	55.9	38.9	0.0	53.2	3	2.0	0.0
238	1554+71.801(1)	2	90	58.6	41.6	0.0	55.9	9	2.1	1.0
239	1551+04.924(1)	2	90	61.4	45.0	0.0	58.6	8	2.0	2.0
240	1547+38.046(1)	2	90	57.3	47.7	0.0	55.9	8	2.0	1.0
241	1543+71.169(1)	2	90	57.3	51.1	0.0	56.6	8	2.0	0.0
242	1540+04.292(1)	2	90	57.3	53.2	0.0	56.6	9	2.0	3.0
243	1536+37.414(1)	2	89	57.3	53.9	0.0	56.6	8	2.0	0.0
244	1532+70.537(1)	2	89	57.3	53.9	0.0	56.6	6	2.0	2.0
245	1529+03.660(1)	2	89	57.3	53.9	0.0	56.6	8	2.0	2.0
246	1525+36.782(1)	2	89	57.3	53.9	0.0	56.6	8	2.0	0.0
247	1521+69.905(1)	2	89	60.0	55.2	0.0	59.3	8	2.0	0.0
248	1518+03.027(1)	2	89	60.0	55.9	0.0	59.3	7	2.0	0.0
249	1514+36.150(1)	2	89	59.3	54.5	0.0	58.6	4	2.0	1.0
250	1510+69.273(1)	2	89	59.3	51.8	0.0	58.0	2	2.0	0.0
251	1507+02.395(1)	2	89	59.3	48.4	0.0	57.3	2	2.0	0.0
252	1503+35.518(1)	2	89	56.6	47.0	0.0	55.2	3	2.0	1.0
253	1499+68.641(1)	2	89	56.6	47.0	0.0	55.2	3	2.0	1.0
254	1496+01.763(1)	2	89	56.6	48.4	0.0	55.2	3	2.0	0.0
255	1492+34.886(1)	2	89	56.6	50.5	0.0	55.9	3	2.0	0.0
256	1488+68.008(1)	2	89	57.3	52.5	0.0	56.6	3	2.0	0.0
257	1485+01.131(1)	2	89	57.3	53.2	0.0	56.6	3	2.0	1.0
258	1481+34.254(1)	2	89	60.0	55.9	0.0	59.3	3	2.0	0.0
259	1477+67.376(1)	2	89	57.3	53.9	0.0	56.6	4	2.0	1.0
260	1474+00.499(1)	2	89	57.3	53.9	0.0	56.6	4	2.0	1.0
261	1470+33.622(1)	2	89	57.3	53.9	0.0	56.6	6	2.0	0.0
262	1466+66.744(1)	2	89	58.6	53.2	0.0	57.3	4	2.0	0.0
263	1462+99.867(1)	2	89	60.7	52.5	0.0	59.3	7	2.0	1.0
264	1459+32.989(1)	2	89	61.4	51.8	0.0	60.0	3	2.0	0.0
265	1455+66.112(1)	2	90	61.4	51.8	0.0	59.3	7	2.0	2.0
266	1451+99.235(1)	2	90	60.7	51.1	0.0	59.3	9	2.0	0.0

Station Number	Station	Number of Lanes	Traffic Volume (vpd)	Speed Mean Cars (mph)	Speed Mean Trucks (mph)	Speed Mean RVs (mph)	Speed Mean All (mph)	Percent Following (%)	Platoon Size	Number of Passes
267	1448+32.357(1)	1	90	61.6	52.6	0.0	60.2	10	2.1	0.0
268	1444+65.480(1)	1	90	61.9	54.3	0.0	60.7	10	2.1	0.0
269	1440+98.603(1)	1	90	61.3	56.3	0.0	60.5	10	2.1	0.0
270	1437+31.725(1)	1	90	57.3	53.5	0.0	56.7	8	2.2	0.0
271	1433+64.848(1)	1	90	57.3	53.5	0.0	56.7	10	2.1	1.0
272	1429+97.970(1)	1	90	57.2	53.5	0.0	56.7	10	2.1	0.0
273	1426+31.093(1)	1	90	61.0	54.5	0.0	60.0	11	2.3	0.0
274	1422+64.216(1)	1	91	61.2	53.4	0.0	59.9	10	2.3	0.0
275	1418+97.338(1)	1	91	57.4	51.8	0.0	56.5	9	2.3	0.0
276	1415+30.461(1)	1	91	57.6	52.1	0.0	56.7	9	2.3	2.0
277	1411+63.584(1)	1	91	57.7	52.8	0.0	56.9	9	2.3	1.0
278	1407+96.706(1)	1	90	59.3	54.3	0.0	58.4	9	2.3	0.0
279	1404+29.829(1)	1	90	62.2	58.2	0.0	61.5	8	2.4	1.0
280	1400+62.951(1)	1	90	62.1	59.0	0.0	61.6	7	2.5	0.0
281	1396+96.074(1)	1	90	62.1	58.9	0.0	61.6	7	2.5	0.0
282	1393+29.197(1)	1	91	62.0	58.0	0.0	61.4	7	2.5	0.0
283	1389+62.319(1)	1	91	62.1	58.8	0.0	61.6	7	2.5	0.0
284	1385+95.442(1)	1	91	62.1	59.0	0.0	61.6	7	2.5	0.0
285	1382+28.565(1)	1	91	62.1	59.0	0.0	61.6	7	2.5	0.0
286	1378+61.687(1)	1	91	62.1	59.0	0.0	61.6	7	2.5	0.0
287	1374+94.810(1)	1	91	58.4	54.1	0.0	57.7	7	2.5	0.0
288	1371+27.932(1)	1	91	57.8	53.7	0.0	57.1	8	2.4	0.0
289	1367+61.055(1)	1	92	57.8	53.7	0.0	57.1	8	2.2	0.0
290	1363+94.178(1)	1	92	57.6	53.7	0.0	56.9	8	2.2	0.0
291	1360+27.300(1)	1	92	57.9	53.7	0.0	57.2	8	2.2	0.0
292	1356+60.423(1)	1	92	60.1	55.4	0.0	59.3	9	2.1	1.0
293	1352+93.546(1)	1	93	57.0	52.0	0.0	56.3	10	2.1	1.0
294	1349+26.668(1)	1	93	58.7	53.0	0.0	57.8	10	2.1	1.0
295	1345+59.791(1)	1	93	58.6	54.0	0.0	57.9	11	2.1	0.0
296	1341+92.913(1)	1	93	58.0	53.7	0.0	57.3	10	2.1	0.0
297	1338+26.036(1)	1	93	57.9	53.7	0.0	57.2	9	2.1	0.0
298	1334+59.159(1)	1	93	60.4	55.0	0.0	59.5	11	2.0	0.0
299	1330+92.281(1)	1	93	62.1	57.2	0.0	61.3	11	2.0	0.0
300	1327+25.404(1)	1	93	62.2	58.3	0.0	61.6	12	2.0	0.0

## **Appendix B. DOT&PF Crash Data**

ACCNUM	CDSTRTE	ROADNAME	ACCMPT	YEAR	ACCDATE	NUMVEH	ACCSEVERITY	TOTINJ	EVETYPE	EVELOC	WEATHER	SURFACECOND	LIGHT	DIRECTION	IHSDM_TYPE	LAT_DD	LONG_DD	MP	UID	Accident	Label
200801033	170000	PARKS HIGHWAY	269.715	2008	20080205	1	NON-INCAPACITATING/POSSIBLE INJURY	1	CROSS MEDIAN/CENTERLINE	ROADWAY	CLEAR	ICE	DAYLIGHT	SOUTH	SINGLE VEHICLE	64.56975704	-149.1082649	305	7	2	Injury
200801479	170000	PARKS HIGHWAY	278.314	2008	20080220	1	PROPERTY DAMAGE ONLY	0	DITCH	ROADWAY	CLEAR	ICE	DAYLIGHT	SOUTH	SINGLE VEHICLE	64.6599999	-148.9575469	314	18	1	Property Damage Only
200801508	170000	PARKS HIGHWAY	279.588	2008	20080221	1	NON-INCAPACITATING/POSSIBLE INJURY	1	DITCH	ROADWAY	CLOUDY	ICE	DARK - ROADWAY NOT LIGHTED	NORTH	SINGLE VEHICLE	64.67024911	-148.9228788	316	23	2	Injury
200810214	170000	PARKS HIGHWAY	278.314	2008	20081107	1	PROPERTY DAMAGE ONLY	0	RAN OFF ROAD	ROADWAY	CLEAR	ICE	DAYLIGHT	SOUTH	SINGLE VEHICLE	64.6599999	-148.9575469	314	33	1	Property Damage Only
200810224	170000	PARKS HIGHWAY	273.079	2008	20081107	1	INCAPACITATING INJURY	1	DITCH	ROADWAY	CLEAR	DRY	OTHER	NORTH	SINGLE VEHICLE	64.60921095	-149.0828319	309	5	3	Injury
200812553	170000	PARKS HIGHWAY	276.328	2008	20081211	1	PROPERTY DAMAGE ONLY	0	ANIMAL	ROADWAY	CLEAR	ICE	DARK - UNKNOWN LIGHTING	NORTH	SINGLE VEHICLE	64.64055654	-149.0067678	312	25	1	Property Damage Only
200853411	170000	PARKS HIGHWAY	280.291	2008	20080824	1	PROPERTY DAMAGE ONLY	0	MOOSE	ROADWAY	CLEAR	DRY	TWILIGHT	NORTH	SINGLE VEHICLE	64.67583162	-148.903332	316	4	1	Property Damage Only
200853518	170000	PARKS HIGHWAY	277.316	2008	20080907	1	PROPERTY DAMAGE ONLY	0	MOOSE	ROADWAY	CLOUDY	DRY	TWILIGHT	SOUTH	SINGLE VEHICLE	64.65022681	-148.9822935	313	6	1	Property Damage Only
200901673	170000	PARKS HIGHWAY	278.314	2009	20090127	2	PROPERTY DAMAGE ONLY	0	VEH - ANGLE	ROADWAY	CLEAR	ICE	DARK - ROADWAY NOT LIGHTED	NORTH	MULTI VEHICLE	64.6599999	-148.9575469	314	11	1	Property Damage Only
200905268	170000	PARKS HIGHWAY	270.366	2009	20090411	1	NON-INCAPACITATING/POSSIBLE INJURY	1	RAN OFF ROAD	ROADWAY	CLEAR	DRY	DAYLIGHT	SOUTH	SINGLE VEHICLE	64.57668268	-149.1189308	306	29	2	Injury
200906368	170000	PARKS HIGHWAY	283.364	2009	20090309	1	PROPERTY DAMAGE ONLY	0	DITCH	ROADWAY	CLEAR	ICE	DAYLIGHT	NORTH	SINGLE VEHICLE	64.6976245	-148.8169438	319	21	1	Property Damage Only
200962157	170000	PARKS HIGHWAY	285.397	2009	20091125	1	INCAPACITATING INJURY	2	DITCH	ROADWAY	CLOUDY	ICE	DAYLIGHT	SOUTH	SINGLE VEHICLE	64.69743795	-148.7583653	321	30	3	Injury
200962159	170000	PARKS HIGHWAY	285.194	2009	20091127	1	PROPERTY DAMAGE ONLY	0	DITCH	ROADWAY	CLOUDY	ICE	TWILIGHT	SOUTH	SINGLE VEHICLE	64.69693579	-148.7647914	321	32	1	Property Damage Only
200962746	170000	PARKS HIGHWAY	269.715	2009	20091117	1	PROPERTY DAMAGE ONLY	0	DITCH	ROADWAY	CLEAR	DRY	DARK - ROADWAY NOT LIGHTED	NORTH	SINGLE VEHICLE	64.56975704	-149.1082649	305	1	1	Property Damage Only
200962747	170000	PARKS HIGHWAY	281.364	2009	20091209	1	NON-INCAPACITATING/POSSIBLE INJURY	1	DITCH	ROADWAY	CLOUDY	ICE	DAYLIGHT	NORTH	SINGLE VEHICLE	64.68015263	-148.870193	317	17	2	Injury
200962748	170000	PARKS HIGHWAY	285.297	2009	20091208	1	PROPERTY DAMAGE ONLY	0	DITCH	ROADWAY	CLOUDY	ICE	DARK - ROADWAY NOT LIGHTED	SOUTH	SINGLE VEHICLE	64.69681039	-148.7613877	321	10	1	Property Damage Only
201092050	170000	PARKS HIGHWAY	285.297	2010	20100212	2	PROPERTY DAMAGE ONLY	0	DITCH	ROADWAY	CLOUDY	ICE	DAYLIGHT	SOUTH	MULTI VEHICLE	64.69681039	-148.7613877	321	22	1	Property Damage Only
201092051	170000	PARKS HIGHWAY	274.401	2010	20101213	1	PROPERTY DAMAGE ONLY	0	MOOSE	ROADWAY	BLOWING, SAND, SOIL, DIRT, SNOW	ICE	DARK - ROADWAY NOT LIGHTED	NORTH	SINGLE VEHICLE	64.62552311	-149.0606105	310	9	1	Property Damage Only
201092067	170000	PARKS HIGHWAY	284.294	2010	20100218	1	NON-INCAPACITATING/POSSIBLE INJURY	2	RAN OFF ROAD	ROADWAY	SNOW	DRY	DARK - ROADWAY NOT LIGHTED	NORTH	SINGLE VEHICLE	64.70347408	-148.7897602	320	15	2	Injury
201092356	170000	PARKS HIGHWAY	283.592	2010	20101017	2	PROPERTY DAMAGE ONLY	0	PARKED VEHICLE	ROADSIDE	CLEAR	ICE	DARK - ROADWAY NOT LIGHTED	SOUTH	MULTI VEHICLE	64.69981625	-148.8112231	320	3	1	Property Damage Only
201092702	170000	PARKS HIGHWAY	270.766	2010	20100630	1	INCAPACITATING INJURY	3	BICYCLIST	SHOULDER	CLOUDY	DRY	DAYLIGHT	SOUTH	VEHICLE BICYCLE	64.58246335	-149.1188239	307	37	3	Injury
201093370	170000	PARKS HIGHWAY	274.861	2010	20100219	2	PROPERTY DAMAGE ONLY	0	VEH - ANGLE	ROADWAY	CLOUDY	ICE	DARK - ROADWAY NOT LIGHTED	NORTH	MULTI VEHICLE	64.6301287	-149.0496101	311	31	1	Property Damage Only
201093371	170000	PARKS HIGHWAY	288.023	2010	20100605	1	NON-INCAPACITATING/POSSIBLE INJURY	1	TREE	ROADSIDE	CLOUDY	WET	DAYLIGHT	NORTH	SINGLE VEHICLE	64.70285469	-148.679949	324	2	2	Injury
201093372	170000	PARKS HIGHWAY	288.327	2010	20101017	1	PROPERTY DAMAGE ONLY	0	DITCH	ROADWAY	CLEAR	ICE	DAYLIGHT	NORTH	SINGLE VEHICLE	64.70399958	-148.6700711	324	13	1	Property Damage Only
201093394	170000	PARKS HIGHWAY	285.497	2010	20100108	1	PROPERTY DAMAGE ONLY	0	DITCH	ROADWAY	CLOUDY	ICE	DAYLIGHT	NORTH	SINGLE VEHICLE	64.6979034	-148.7552068	321	8	1	Property Damage Only
201100628	170000	PARKS HIGHWAY	272.402	2011	20110418	1	NON-INCAPACITATING/POSSIBLE INJURY	1	CROSS MEDIAN/CENTERLINE	ROADWAY	CLEAR	DRY	DAYLIGHT	NORTH	SINGLE VEHICLE	64.60335402	-149.100327	308	16	2	Injury
201100629	170000	PARKS HIGHWAY	285.297	2011	20110102	1	NON-INCAPACITATING/POSSIBLE INJURY	2	RAN OFF ROAD	ROADWAY	CLOUDY	ICE	DAYLIGHT	SOUTH	SINGLE VEHICLE	64.69681039	-148.7613877	321	38	2	Injury
201101173	170000	PARKS HIGHWAY	281.364	2011	20111110	1	PROPERTY DAMAGE ONLY	0	RAN OFF ROAD	ROADSIDE	SNOW	ICE	DAYLIGHT	SOUTH	SINGLE VEHICLE	64.68015263	-148.870193	317	34	1	Property Damage Only
201103399	170000	PARKS HIGHWAY	287.22	2011	20110507	1	PROPERTY DAMAGE ONLY	0	RAN OFF ROAD	SHOULDER	CLEAR	DRY	UNKNOWN	NORTH	SINGLE VEHICLE	64.69871206	-148.7048339	323	20	1	Property Damage Only
201103422	170000	PARKS HIGHWAY	271.384	2011	20110927	1	PROPERTY DAMAGE ONLY	0	MOOSE	ROADWAY	CLEAR	DRY	DARK - ROADWAY NOT LIGHTED	SOUTH	SINGLE VEHICLE	64.59136436	-149.1181454	307	35	1	Property Damage Only
201105041	170000	PARKS HIGHWAY	281.454	2011	20110125	1	PROPERTY DAMAGE ONLY	0	RAN OFF ROAD	ROADSIDE	CLEAR	ICE	DARK - ROADWAY NOT LIGHTED	SOUTH	SINGLE VEHICLE	64.68092509	-148.8677531	317	12	1	Property Damage Only
201200018	170000	PARKS HIGHWAY	272.902	2012	20120307	2	NON-INCAPACITATING/POSSIBLE INJURY	1	VEH - ANGLE	ROADWAY	SNOW	SNOW	DAYLIGHT	NORTH	MULTI VEHICLE	64.60721544	-149.0865513	309	24	2	Injury
201200019	170000	PARKS HIGHWAY	285.297	2012	20120208	1	NON-INCAPACITATING/POSSIBLE INJURY	1	GUARDRAIL FACE	ROADWAY	CLEAR	ICE	DARK - UNKNOWN LIGHTING	SOUTH	SINGLE VEHICLE	64.69681039	-148.7613877	321	14	2	Injury
201203510	170000	PARKS HIGHWAY	274.861	2012	20120319	1	PROPERTY DAMAGE ONLY	0	MOOSE	ROADWAY	CLEAR	DRY	DARK - ROADWAY NOT LIGHTED	SOUTH	SINGLE VEHICLE	64.6301287	-149.0496101	311	26	1	Property Damage Only
201204733	170000	PARKS HIGHWAY	273.455	2012	20120916	1	PROPERTY DAMAGE ONLY	0	MOOSE	ROADWAY	RAIN	WET	DARK - ROADWAY NOT LIGHTED	SOUTH	SINGLE VEHICLE	64.61345017	-149.0749302	309	28	1	Property Damage Only
201205046	170000	PARKS HIGHWAY	275.34	2012	20121228	1	PROPERTY DAMAGE ONLY	0	MOOSE	ROADWAY	SNOW	ICE	DARK - ROADWAY NOT LIGHTED	SOUTH	SINGLE VEHICLE	64.63335341	-149.0353387	311	19	1	Property Damage Only
201270936	170000	PARKS HIGHWAY	275.543	2012	20120104	1	PROPERTY DAMAGE ONLY	0	MOOSE	ROADWAY	SNOW	SNOW	DARK - ROADWAY NOT LIGHTED	NORTH	SINGLE VEHICLE	64.63470655	-149.0292422	311	36	1	Property Damage Only
201271296	170000	PARKS HIGHWAY	289.33	2012	20120115	1	PROPERTY DAMAGE ONLY	0	DITCH	ROADWAY	CLEAR	ICE	DAYLIGHT	NORTH	SINGLE VEHICLE	64.70665057	-148.6378311	325	27	1	Property Damage Only
201302946	170000	PARKS HIGHWAY	287.9035	2013	20130217	1	NO APPARENT INJURY	0	GUARDRAIL FACE	ON ROADSIDE	SNOW	ICE/FROST	DUSK	NOT APPLICABLE	SINGLE VEHICLE	64.70234344	-148.6838027	324	64	1	Property Damage Only
201303402	170000	PARKS HIGHWAY	285.5539	2013	20130515	1	SUSPECTED MINOR INJURY	5	OVERTURN/ROLLOVER	ON SHOULDER	NO ADDITIONAL ATMOSPHERIC CONDITIONS	ICE/FROST	DAYLIGHT	NOT APPLICABLE	SINGLE VEHICLE	64.69779863	-148.7533111	321	63	2	Injury
201303404	170000	PARKS HWY	286.2893	2013	20130512	1	NO APPARENT INJURY	0	GUARDRAIL FACE	ON ROADSIDE	SNOW	SNOW	DAYLIGHT	NOT APPLICABLE	SINGLE VEHICLE	64.70198989	-148.7332732	322	61	1	Property Damage Only
201303742	170000	PARKS HIGHWAY	278.7944	2013	20130630	2	SUSPECTED MINOR INJURY	2	MOTOR VEHICLE IN-TRANSPORT	ON ROADWAY	NO ADDITIONAL ATMOSPHERIC CONDITIONS	DRY	DAYLIGHT	SOUTH	MULTI VEHICLE	64.66469987	-148.9456263	315	66	2	Injury
201305204	170000	PARKS HIGHWAY	274.7517	2013	20131220	1	NO APPARENT INJURY	0	OVERTURN/ROLLOVER	OUTSIDE TRAFFICWAY	NO ADDITIONAL ATMOSPHERIC CONDITIONS	ICE/FROST	DAWN	NOT APPLICABLE	SINGLE VEHICLE	64.62922482	-149.0526227	311	65	1	Property Damage Only
201347917	170000	PARKS HIGHWAY	273.5439	2013	20130617	1	POSSIBLE INJURY	1	DITCH	OUTSIDE TRAFFICWAY	CLEAR	DRY	DAYLIGHT	NORTH	SINGLE VEHICLE	64.61445413	-149.073068	310	62	2	Injury
201437075	170000	PARKS HIGHWAY	281.068	2014	20140310	1	NO APPARENT INJURY	0	SNOW BANK	ON ROADWAY	CLOUDY	ICE/FROST	DARK-NOT LIGHTED	NOT APPLICABLE	SINGLE VEHICLE	64.67780943	-148.8784588	317	56	1	Property Damage Only
201448411	170000	PARKS HIGHWAY	286.0794	2014	20140719	1	NO APPARENT INJURY	0	TREE (STANDING ONLY)	ON ROADWAY	RAIN	WET	DAWN	NOT APPLICABLE	SINGLE VEHICLE	64.6999094	-148.7383785	322	55	1	Property Damage Only
201455023	170000	PARKS HIGHWAY	266.2656	2014	20140917	1	NO APPARENT INJURY	0	LIVE ANIMAL	ON ROADWAY	CLOUDY	DRY	DARK-UNKNOWN LIGHTING	SOUTH	SINGLE VEHICLE	64.52489105	-149.0675876	302	43	1	Property Damage Only
201462539	170000	PARKS HIGHWAY	287.0127	2014	20140310	1	NO APPARENT INJURY	0	SNOW BANK	ON SHOULDER	CLEAR	ICE/FROST	DAYLIGHT	SOUTH	SINGLE VEHICLE	64.69895286	-148.7115453	323	53	1	Property Damage Only
201462652	170000	PARKS HIGHWAY	272.919	2014	20140609	2	NO APPARENT INJURY	0	MOTOR VEHICLE IN-TRANSPORT	ON ROADWAY	CLEAR	DRY	DAYLIGHT	NOT APPLICABLE	MULTI VEHICLE	64.60741841	-149.0861757	309	41	1	Property Damage Only
201463351	170000	PARKS HIGHWAY	270.6721	2014	20140710	1	NO APPARENT INJURY	0	LIVE ANIMAL	ON ROADWAY	CLOUDY	DRY	DUSK	NORTH	SINGLE VEHICLE	64.58111175	-149.1188593	306	59	1	Property Damage Only
201464124	170000	PARKS HIGHWAY	285.0797	2014	20140201	1	NO APPARENT INJURY	0	GUARDRAIL FACE	ON ROADSIDE	CLOUDY	ICE/FROST	DAWN	SOUTH	SINGLE VEHICLE	64.69807067	-148.76748	321	47	1	Property Damage Only
201464302	170000	PARKS HIGHWAY	272.2717	2014	20140206	2	SUSPECTED MINOR INJURY	1	MOTOR VEHICLE IN-TRANSPORT	ON ROADWAY	BLOWING SNOW	SNOW	DAYLIGHT	NORTH	MULTI VEHICLE	64.60249199	-149.104213	308	49	2	Injury
201464382	170000	PARK																			



## **Appendix C. IHSDM CPM Reports**

*Interactive Highway Safety Design Model*

**Crash Prediction Evaluation Report**

**Existing Alignment**

January 18, 2018



## **Disclaimer**

The Interactive Highway Design Model (IHSDM) software is disseminated under the sponsorship of the Department of Transportation in the interest of information exchange. The United States Government assumes no liability for its content or use thereof. This document does not constitute a standard, specification, or regulation.

The United States Government does not endorse products or manufacturers. Trade and manufacturers' names may appear in this software and documentation only because they are considered essential to the objective of the software.

## **Limited Warranty and Limitations of Remedies**

This software product is provided "as-is," without warranty of any kind-either expressed or implied (but not limited to the implied warranties of merchantability and fitness for a particular purpose). The FHWA do not warrant that the functions contained in the software will meet the end-user's requirements or that the operation of the software will be uninterrupted and error-free.

Under no circumstances will the FHWA be liable to the end-user for any damages or claimed lost profits, lost savings, or other incidental or consequential damages rising out of the use or inability to use the software (even if these organizations have been advised of the possibility of such damages), or for any claim by any other party.

## **Notice**

The use of the IHSDM software is being done strictly on a voluntary basis. In exchange for provision of IHSDM, the user agrees that the Federal Highway Administration (FHWA), U.S. Department of Transportation and any other agency of the Federal Government shall not be responsible for any errors, damage or other liability that may result from any and all use of the software, including installation and testing of the software. The user further agrees to hold the FHWA and the Federal Government harmless from any resulting liability. The user agrees that this hold harmless provision shall flow to any person to whom or any entity to which the user provides the IHSDM software. It is the user's full responsibility to inform any person to whom or any entity to which it provides the IHSDM software of this hold harmless provision.

---

---

## Table of Contents

<b>Report Overview</b> .....	<b>1</b>
<b>Section 1 Evaluation</b> .....	<b>2</b>

## List of Tables

Table Observed Crashes Used in the Evaluation (Section 1) .....	3
Table Evaluation Highway - Homogeneous Segments (Section 1) .....	4
Table Crash History Highway - Homogeneous Segments (Section 1) .....	8
Table Expected Highway Crash Rates and Frequencies (Section 1) .....	12
Table Expected Crash Frequencies and Rates by Highway Segment (Section 1) .....	12
Table Expected Crash Frequencies and Rates by Horizontal Design Element (Section 1) .....	15
Table Expected Segment Crash Type Distribution (Section 1) .....	18

## List of Figures

Figure Crash Prediction Summary (Section 1) .....	2
---	---

## Report Overview

**Report Generated:** Jan 18, 2018 8:59 AM

**Report Template:** System: Multi-Page, 508 Compliant [System] (mlcpm4, Oct 9, 2017 1:45 PM)

**Evaluation Date:** Tue Jan 16 15:43:08 AKST 2018

**IHSDM Version:** v13.0.0 (Sep 13, 2017)

**Crash Prediction Module:** v8.0.0 (Sep 13, 2017)

**User Name:** RaeAnne Hebnes

**Organization Name:** Michael Baker International

**Phone:**

**E-Mail:**

**Project Title:** Parks 305 - 325 v2

**Project Comment:** Created using wizard

**Project Unit System:** U.S. Customary

**Highway Title:** Alignment ParksHwy304-326 Asbuilt - 60 mph

**Highway Comment:** Created By Civil Geometry

**Highway Version:** 1

**Evaluation Title:** Evaluation 21

**Evaluation Comment:** Created Tue Jan 16 15:40:06 AKST 2018

**Minimum Station:** 1327+09.000

**Maximum Station:** 2487+37.299

**Policy for Superelevation:** AASHTO 2011 U.S. Customary

**Calibration:** HSM Configuration

**Crash Distribution:** HSM Configuration

**Model/CMF:** HSM Configuration

**Empirical-Bayes Analysis:** Site-Specific

**Highway with Crash History:** Alignment ParksHwy304-326 Asbuilt - 60 mph

**Highway with Crash History Comment:** Created By Civil Geometry

**Highway with Crash History Version:** 1

**First Year of Analysis:** 2017

**Last Year of Analysis:** 2017

# Section 1 Evaluation

**Section:** Section 1  
**Evaluation Start Location:** 1327+09.000  
**Evaluation End Location:** 2487+37.299  
**Area Type:** Rural  
**Functional Class:** Arterial  
**Type of Alignment:** Undivided, Two Lane  
**Model Category:** Rural, Two Lane  
**Calibration Factor:** 2U=1.0;

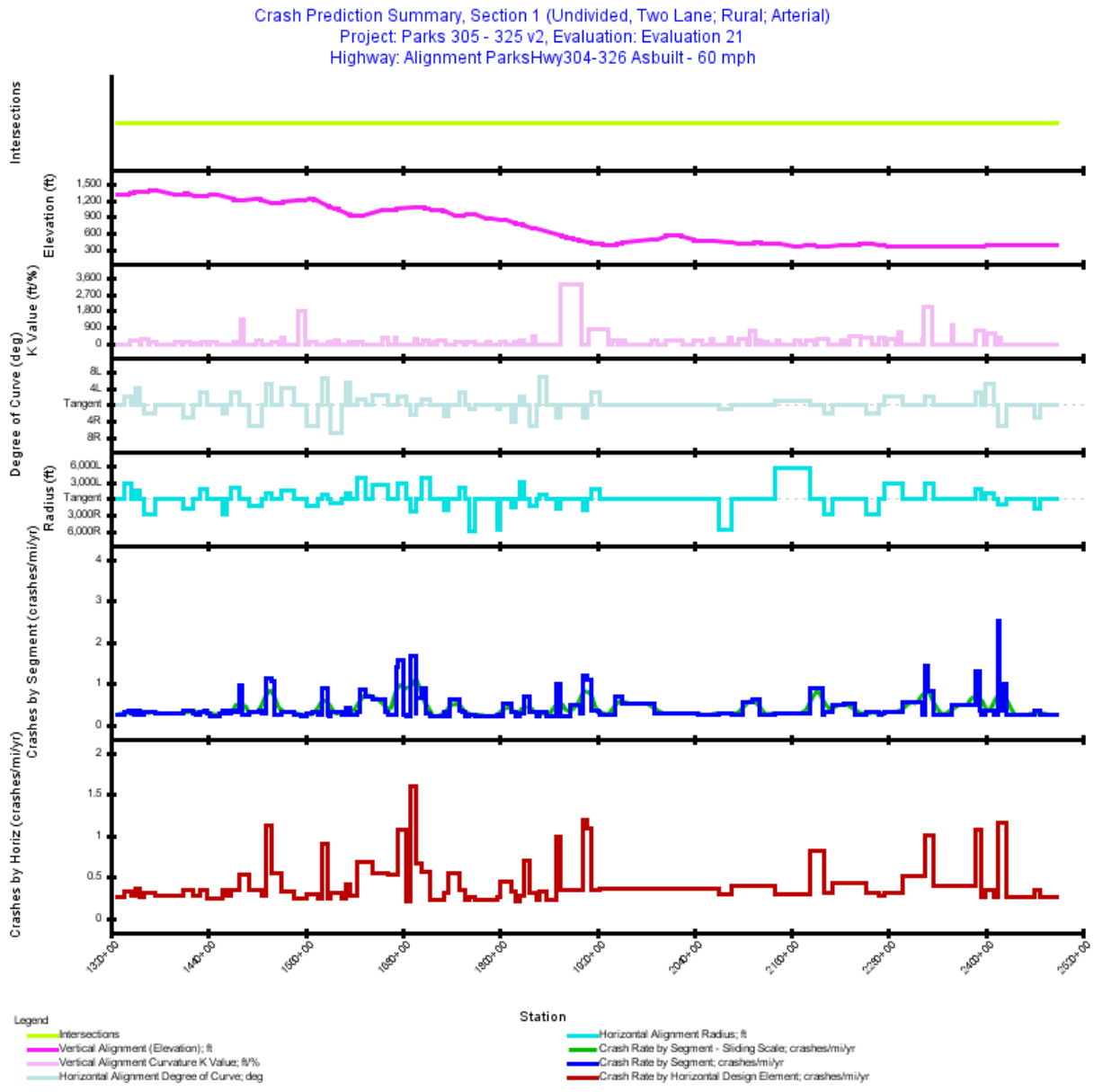

**Figure 1. Crash Prediction Summary (Section 1)**



**Table 1. Observed Crashes Used in the Evaluation (Section 1)**

Year	Observed Crashes	Total Crashes Used	FI Crashes	FI no/C Crashes	PDO Crashes
2010	9	7	3	1	4
2011	6	6	2	0	4
2012	7	7	2	0	5
2013	6	6	3	0	3
2014	17	16	7	0	9
All Years	45 &nbsp; <sup>[1]</sup>	42	17	1	25

**Footnotes**

<sup>[1]</sup> Note: Observed crash data that does not comply with the associated CPM model requirements may not be used in EB processing.

**Table 2. Evaluation Highway - Homogeneous Segments (Section 1)**

Seg. No.	Type	Start Location	End Location	Length (ft)	Length (mi)	AADT	Left Lane Width (ft)	Right Lane Width (ft)	Left Shoulder Width (ft)	Right Shoulder Width (ft)	Grade (%)	Driveway Density (driveways/mi)	Hazard Rating	Centerline Rumble Strip	Passing Lanes	TWLT Lane	Lighting	Automated Speed Enforcement	Radius (ft)	Superelevation (%)	Adverse	Design Speed (mph)
1	2U	1327+09.000	1336+44.302	935.30	0.1771	2017: 1,800	12.00	12.00	8.00	8.00	0.00	0.3	1	false	0	false	false	false				
2	2U	1336+44.302	1341+64.474	520.17	0.0985	2017: 1,800	12.00	12.00	8.00	8.00	0.00	0.3	1	false	0	false	false	false	2,864.79	2.0	true	60
3	2U	1341+64.474	1345+88.891	424.42	0.0804	2017: 1,800	12.00	12.00	8.00	8.00	6.00	0.3	1	false	0	false	false	false	2,864.79	2.0	true	60
4	2U	1345+88.891	1349+42.437	353.55	0.0670	2017: 1,800	12.00	12.00	8.00	8.00	6.00	0.3	1	false	0	false	false	false				
5	2U	1349+42.437	1350+43.605	101.17	0.0192	2017: 1,800	12.00	12.00	8.00	8.00	0.00	0.3	1	false	0	false	false	false				
6	2U	1350+43.605	1355+75.006	531.40	0.1006	2017: 1,800	12.00	12.00	8.00	8.00	0.00	0.3	1	false	0	false	false	false	1,432.40	2.0	true	60
7	2U	1355+75.006	1359+98.149	423.14	0.0801	2017: 1,800	12.00	12.00	8.00	8.00	0.00	0.3	1	false	0	false	false	false				
8	2U	1359+98.149	1361+84.449	186.30	0.0353	2017: 1,800	12.00	12.00	8.00	8.00	0.00	0.3	1	false	0	false	false	false	2,864.79	2.0	true	60
9	2U	1361+84.449	1372+13.914	1,029.46	0.1950	2017: 1,800	12.00	12.00	8.00	8.00	2.77	0.3	1	false	0	false	false	false	2,864.79	2.0	true	60
10	2U	1372+13.914	1375+23.561	309.65	0.0587	2017: 1,800	12.00	12.00	8.00	8.00	3.10	0.3	1	false	0	false	false	false	2,864.79	2.0	true	60
11	2U	1375+23.561	1403+14.142	2,790.58	0.5285	2017: 1,800	12.00	12.00	8.00	8.00	3.10	0.3	1	false	0	false	false	false				
12	2U	1403+14.142	1409+56.099	641.96	0.1216	2017: 1,800	12.00	12.00	8.00	8.00	4.20	0.3	1	false	0	false	false	false				
13	2U	1409+56.099	1413+11.581	355.48	0.0673	2017: 1,800	12.00	12.00	8.00	8.00	4.20	0.3	1	false	0	false	false	false	1,909.86	2.0	true	60
14	2U	1413+11.581	1420+94.274	782.69	0.1482	2017: 1,800	12.00	12.00	8.00	8.00	4.57	0.3	1	false	0	false	false	false	1,909.86	2.0	true	60
15	2U	1420+94.274	1425+01.019	406.75	0.0770	2017: 1,800	12.00	12.00	8.00	8.00	4.57	0.3	1	false	0	false	false	false				
16	2U	1425+01.019	1429+54.331	453.31	0.0858	2017: 1,800	12.00	12.00	8.00	8.00	0.50	0.3	1	false	0	false	false	false				
17	2U	1429+54.331	1434+88.047	533.72	0.1011	2017: 1,800	12.00	12.00	8.00	8.00	0.50	0.3	1	false	0	false	false	false	1,909.86	2.0	true	60
18	2U	1434+88.047	1439+38.259	450.21	0.0853	2017: 1,800	12.00	12.00	8.00	8.00	3.40	0.3	1	false	0	false	false	false	1,909.86	2.0	true	60
19	2U	1439+38.259	1442+00.000	261.74	0.0496	2017: 1,800	12.00	12.00	8.00	8.00	3.40	0.3	1	false	0	false	false	false				
20	2U	1442+00.000	1445+85.729	385.73	0.0731	2017: 1,800	12.00	12.00	8.00	8.00	3.40	0.3	1	false	1	false	false	false				
21	2U	1445+85.729	1454+00.000	814.27	0.1542	2017: 1,800	12.00	12.00	8.00	8.00	3.50	0.3	1	false	1	false	false	false				
22	2U	1454+00.000	1457+87.869	387.87	0.0735	2017: 1,800	12.00	12.00	8.00	8.00	3.50	0.3	1	false	0	false	false	false				
23	2U	1457+87.869	1463+32.941	545.07	0.1032	2017: 1,800	12.00	12.00	8.00	8.00	3.50	0.3	1	false	0	false	false	false	2,864.79	2.0	true	60
24	2U	1463+32.941	1468+59.089	526.15	0.0997	2017: 1,800	12.00	12.00	8.00	8.00	3.50	0.3	1	false	0	false	false	false				
25	2U	1468+59.089	1473+71.093	512.00	0.0970	2017: 1,800	12.00	12.00	8.00	8.00	3.50	0.3	1	false	0	false	false	false	1,950.00	2.0	true	60
26	2U	1473+71.093	1477+61.956	390.86	0.0740	2017: 1,800	12.00	12.00	8.00	8.00	0.30	0.3	1	false	0	false	false	false	1,950.00	2.0	true	60
27	2U	1477+61.956	1482+39.570	477.61	0.0905	2017: 1,800	12.00	12.00	8.00	8.00	0.30	0.3	1	false	0	false	false	false				
28	2U	1482+39.570	1490+31.091	791.52	0.1499	2017: 1,800	12.00	12.00	8.00	8.00	0.60	0.3	1	false	0	false	false	false				
29	2U	1490+31.091	1502+99.266	1,268.17	0.2402	2017: 1,800	12.00	12.00	8.00	8.00	0.60	0.3	1	false	0	false	false	false	1,155.00	2.0	true	60
30	2U	1502+99.266	1506+85.128	385.86	0.0731	2017: 1,800	12.00	12.00	8.00	8.00	4.20	0.3	1	false	0	false	false	false	1,155.00	2.0	true	60
31	2U	1506+85.128	1511+36.056	450.93	0.0854	2017: 1,800	12.00	12.00	8.00	8.00	4.20	0.3	1	false	0	false	false	false				
32	2U	1511+36.056	1518+02.293	666.24	0.1262	2017: 1,800	12.00	12.00	8.00	8.00	4.20	0.3	1	false	0	false	false	false	1,145.92	2.0	true	60
33	2U	1518+02.293	1522+56.443	454.15	0.0860	2017: 1,800	12.00	12.00	8.00	8.00	4.20	0.3	1	false	0	false	false	false				
34	2U	1522+56.443	1530+56.765	800.32	0.1516	2017: 1,800	12.00	12.00	8.00	8.00	2.40	0.3	1	false	0	false	false	false				
35	2U	1530+56.765	1532+29.037	172.27	0.0326	2017: 1,800	12.00	12.00	8.00	8.00	2.40	0.3	1	false	0	false	false	false	1,440.00	2.0	true	60
36	2U	1532+29.037	1546+35.066	1,406.03	0.2663	2017: 1,800	12.00	12.00	8.00	8.00	1.55	0.3	1	false	0	false	false	false	1,440.00	2.0	true	60
37	2U	1546+35.066	1555+00.000	864.93	0.1638	2017: 1,800	12.00	12.00	8.00	8.00	1.55	0.3	1	false	0	false	false	false				
38	2U	1555+00.000	1555+42.935	42.94	0.0081	2017: 1,800	12.00	12.00	8.00	8.00	1.55	0.3	1	false	1	false	false	false				
39	2U	1555+42.935	1561+65.077	622.14	0.1178	2017: 1,800	12.00	12.00	8.00	8.00	2.00	0.3	1	false	1	false	false	false				
40	2U	1561+65.077	1568+88.080	723.00	0.1369	2017: 1,800	12.00	12.00	8.00	8.00	2.00	0.3	1	false	1	false	false	false	1,152.00	2.0	true	60

Seg. No.	Type	Start Location	End Location	Length (ft)	Length (mi)	AADT	Left Lane Width (ft)	Right Lane Width (ft)	Left Shoulder Width (ft)	Right Shoulder Width (ft)	Grade (%)	Driveway Density (driveways/mi)	Hazard Rating	Centerline Rumble Strip	Passing Lanes	TWLT Lane	Lighting	Automated Speed Enforcement	Radius (ft)	Superelevation (%)	Adverse	Design Speed (mph)
41	2U	1568+88.080	1575+49.666	661.59	0.1253	2017: 1,800	12.00	12.00	8.00	8.00	7.00	0.3	1	false	1	false	false	false	1,152.00	2.0	true	60
42	2U	1575+49.666	1579+81.473	431.81	0.0818	2017: 1,800	12.00	12.00	8.00	8.00	7.00	0.3	1	false	1	false	false	false				
43	2U	1579+81.473	1587+62.614	781.14	0.1479	2017: 1,800	12.00	12.00	8.00	8.00	7.00	0.3	1	false	1	false	false	false	881.47	2.0	true	60
44	2U	1587+62.614	1589+20.405	157.79	0.0299	2017: 1,800	12.00	12.00	8.00	8.00	7.00	0.3	1	false	1	false	false	false				
45	2U	1589+20.405	1591+85.378	264.97	0.0502	2017: 1,800	12.00	12.00	8.00	8.00	3.90	0.3	1	false	1	false	false	false				
46	2U	1591+85.378	1598+89.259	703.88	0.1333	2017: 1,800	12.00	12.00	8.00	8.00	3.90	0.3	1	false	1	false	false	false	825.00	2.0	true	60
47	2U	1598+89.259	1604+98.065	608.81	0.1153	2017: 1,800	12.00	12.00	8.00	8.00	7.00	0.3	1	false	1	false	false	false	825.00	2.0	true	60
48	2U	1604+98.065	1609+35.192	437.13	0.0828	2017: 1,800	12.00	12.00	8.00	8.00	7.00	0.3	1	false	1	false	false	false				
49	2U	1609+35.192	1610+00.000	64.81	0.0123	2017: 1,800	12.00	12.00	8.00	8.00	7.00	0.3	1	false	1	false	false	false	1,041.74	2.0	true	60
50	2U	1610+00.000	1614+65.403	465.40	0.0881	2017: 1,800	12.00	12.00	8.00	8.00	7.00	0.3	1	false	0	false	false	false	1,041.74	2.0	true	60
51	2U	1614+65.403	1615+65.837	100.43	0.0190	2017: 1,800	12.00	12.00	8.00	8.00	7.00	0.3	1	false	0	false	false	false				
52	2U	1615+65.837	1623+55.342	789.50	0.1495	2017: 1,800	12.00	12.00	8.00	8.00	0.70	0.3	1	false	0	false	false	false				
53	2U	1623+55.342	1627+06.536	351.19	0.0665	2017: 1,800	12.00	12.00	8.00	8.00	0.70	0.3	1	false	0	false	false	false	3,819.72	2.0	true	60
54	2U	1627+06.536	1634+67.324	760.79	0.1441	2017: 1,800	12.00	12.00	8.00	8.00	3.30	0.3	1	false	0	false	false	false	3,819.72	2.0	true	60
55	2U	1634+67.324	1643+43.433	876.11	0.1659	2017: 1,800	12.00	12.00	8.00	8.00	3.30	0.3	1	false	0	false	false	false				
56	2U	1643+43.433	1658+40.396	1,496.96	0.2835	2017: 1,800	12.00	12.00	8.00	8.00	3.30	0.3	1	false	0	false	false	false	2,546.48	2.0	true	60
57	2U	1658+40.396	1662+05.617	365.22	0.0692	2017: 1,800	12.00	12.00	8.00	8.00	0.70	0.3	1	false	0	false	false	false	2,546.48	2.0	true	60
58	2U	1662+05.617	1671+65.038	959.42	0.1817	2017: 1,800	12.00	12.00	8.00	8.00	0.70	0.3	1	false	0	false	false	false				
59	2U	1671+65.038	1674+56.874	291.84	0.0553	2017: 1,800	12.00	12.00	8.00	8.00	1.30	0.3	1	false	0	false	false	false				
60	2U	1674+56.874	1681+00.000	643.13	0.1218	2017: 1,800	12.00	12.00	8.00	8.00	1.30	0.3	1	false	0	false	false	false	2,864.79	2.0	true	60
61	2U	1681+00.000	1684+84.121	384.12	0.0727	2017: 1,800	12.00	12.00	8.00	8.00	1.30	0.3	1	false	1	false	false	false	2,864.79	2.0	true	60
62	2U	1684+84.121	1689+55.548	471.43	0.0893	2017: 1,800	12.00	12.00	8.00	8.00	1.30	0.3	1	false	1	false	false	false				
63	2U	1689+55.548	1696+91.231	735.68	0.1393	2017: 1,800	12.00	12.00	8.00	8.00	1.30	0.3	1	false	1	false	false	false	2,291.83	2.0	true	60
64	2U	1696+91.231	1697+38.184	46.95	0.0089	2017: 1,800	12.00	12.00	8.00	8.00	0.60	0.3	1	false	1	false	false	false	2,291.83	2.0	true	60
65	2U	1697+38.184	1703+52.875	614.69	0.1164	2017: 1,800	12.00	12.00	8.00	8.00	0.60	0.3	1	false	1	false	false	false				
66	2U	1703+52.875	1708+54.649	501.77	0.0950	2017: 1,800	12.00	12.00	8.00	8.00	0.60	0.3	1	false	1	false	false	false	3,819.72	2.0	true	60
67	2U	1708+54.649	1713+92.335	537.69	0.1018	2017: 1,800	12.00	12.00	8.00	8.00	4.00	0.3	1	false	1	false	false	false	3,819.72	2.0	true	60
68	2U	1713+92.335	1716+89.463	297.13	0.0563	2017: 1,800	12.00	12.00	8.00	8.00	4.00	0.3	1	false	1	false	false	false				
69	2U	1716+89.463	1728+08.381	1,118.92	0.2119	2017: 1,800	12.00	12.00	8.00	8.00	0.50	0.3	1	false	1	false	false	false				
70	2U	1728+08.381	1731+17.025	308.64	0.0585	2017: 1,800	12.00	12.00	8.00	8.00	5.30	0.3	1	false	1	false	false	false				
71	2U	1731+17.025	1736+82.212	565.19	0.1070	2017: 1,800	12.00	12.00	8.00	8.00	5.30	0.3	1	false	1	false	false	false	2,150.00	2.0	true	60
72	2U	1736+82.212	1739+00.000	217.79	0.0413	2017: 1,800	12.00	12.00	8.00	8.00	5.30	0.3	1	false	1	false	false	false				
73	2U	1739+00.000	1749+79.705	1,079.70	0.2045	2017: 1,800	12.00	12.00	8.00	8.00	5.30	0.3	1	false	0	false	false	false				
74	2U	1749+79.705	1750+54.678	74.97	0.0142	2017: 1,800	12.00	12.00	8.00	8.00	5.30	0.3	1	false	0	false	false	false	1,950.00	2.0	true	60
75	2U	1750+54.678	1754+00.000	345.32	0.0654	2017: 1,800	12.00	12.00	8.00	8.00	4.60	0.3	1	false	0	false	false	false	1,950.00	2.0	true	60
76	2U	1754+00.000	1756+47.361	247.36	0.0469	2017: 1,800	12.00	12.00	8.00	8.00	4.60	0.3	1	false	1	false	false	false	1,950.00	2.0	true	60
77	2U	1756+47.361	1761+94.171	546.81	0.1036	2017: 1,800	12.00	12.00	8.00	8.00	4.60	0.3	1	false	1	false	false	false				
78	2U	1761+94.171	1764+68.438	274.27	0.0519	2017: 1,800	12.00	12.00	8.00	8.00	4.60	0.3	1	false	1	false	false	false	5,800.00	2.0	true	60
79	2U	1764+68.438	1769+37.986	469.55	0.0889	2017: 1,800	12.00	12.00	8.00	8.00	5.00	0.3	1	false	1	false	false	false	5,800.00	2.0	true	60
80	2U	1769+37.986	1786+03.032	1,665.05	0.3154	2017: 1,800	12.00	12.00	8.00	8.00	5.00	0.3	1	false	1	false	false	false				
81	2U	1786+03.032	1796+26.415	1,023.38	0.1938	2017: 1,800	12.00	12.00	8.00	8.00	0.30	0.3	1	false	1	false	false	false				
82	2U	1796+26.415	1801+11.457	485.04	0.0919	2017: 1,800	12.00	12.00	8.00	8.00	0.30	0.3	1	false	1	false	false	false	5,729.58	2.0	true	60
83	2U	1801+11.457	1803+66.390	254.93	0.0483	2017: 1,800	12.00	12.00	8.00	8.00	0.30	0.3	1	false	1	false	false	false				

Seg. No.	Type	Start Location	End Location	Length (ft)	Length (mi)	AADT	Left Lane Width (ft)	Right Lane Width (ft)	Left Shoulder Width (ft)	Right Shoulder Width (ft)	Grade (%)	Driveway Density (driveways/mi)	Hazard Rating	Centerline Rumble Strip	Passing Lanes	TWLT Lane	Lighting	Automated Speed Enforcement	Radius (ft)	Superelevation (%)	Adverse	Design Speed (mph)
84	2U	1803+66.390	1814+09.517	1,043.13	0.1976	2017: 1,800	12.00	12.00	8.00	8.00	4.90	0.3	1	false	1	false	false	false				
85	2U	1814+09.517	1819+97.464	587.95	0.1114	2017: 1,800	12.00	12.00	8.00	8.00	4.90	0.3	1	false	1	false	false	false	1,450.00	2.0	true	60
86	2U	1819+97.464	1820+48.062	50.60	0.0096	2017: 1,800	12.00	12.00	8.00	8.00	4.90	0.3	1	false	1	false	false	false				
87	2U	1820+48.062	1824+53.898	405.84	0.0769	2017: 1,800	12.00	12.00	8.00	8.00	1.70	0.3	1	false	1	false	false	false				
88	2U	1824+53.898	1826+89.465	235.57	0.0446	2017: 1,800	12.00	12.00	8.00	8.00	1.70	0.3	1	false	1	false	false	false	3,000.00	2.0	true	60
89	2U	1826+89.465	1830+41.880	352.42	0.0668	2017: 1,800	12.00	12.00	8.00	8.00	5.00	0.3	1	false	1	false	false	false	3,000.00	2.0	true	60
90	2U	1830+41.880	1836+58.064	616.18	0.1167	2017: 1,800	12.00	12.00	8.00	8.00	5.00	0.3	1	false	1	false	false	false				
91	2U	1836+58.064	1841+90.386	532.32	0.1008	2017: 1,800	12.00	12.00	8.00	8.00	5.00	0.3	1	false	1	false	false	false	1,160.00	2.0	true	60
92	2U	1841+90.386	1844+74.496	284.11	0.0538	2017: 1,800	12.00	12.00	8.00	8.00	4.00	0.3	1	false	1	false	false	false	1,160.00	2.0	true	60
93	2U	1844+74.496	1849+15.104	440.61	0.0834	2017: 1,800	12.00	12.00	8.00	8.00	4.00	0.3	1	false	1	false	false	false				
94	2U	1849+15.104	1858+04.945	889.84	0.1685	2017: 1,800	12.00	12.00	8.00	8.00	4.00	0.3	1	false	1	false	false	false	825.00	2.0	true	60
95	2U	1858+04.945	1869+49.895	1,144.95	0.2168	2017: 1,800	12.00	12.00	8.00	8.00	4.00	0.3	1	false	1	false	false	false				
96	2U	1869+49.895	1875+20.742	570.85	0.1081	2017: 1,800	12.00	12.00	8.00	8.00	4.00	0.3	1	false	1	false	false	false	1,909.86	2.0	true	60
97	2U	1875+20.742	1887+50.279	1,229.54	0.2329	2017: 1,800	12.00	12.00	8.00	8.00	4.00	0.3	1	false	1	false	false	false				
98	2U	1887+50.279	1899+00.000	1,149.72	0.2177	2017: 1,800	12.00	12.00	8.00	8.00	3.20	0.3	1	false	1	false	false	false				
99	2U	1899+00.000	1902+52.815	352.81	0.0668	2017: 1,800	12.00	12.00	8.00	8.00	3.20	0.3	1	false	0	false	false	false				
100	2U	1902+52.815	1908+15.543	562.73	0.1066	2017: 1,800	12.00	12.00	8.00	8.00	3.20	0.3	1	false	0	false	false	false	1,980.00	2.0	true	60
101	2U	1908+15.543	1912+56.122	440.58	0.0834	2017: 1,800	12.00	12.00	8.00	8.00	3.20	0.3	1	false	0	false	false	false				
102	2U	1912+56.122	1922+09.301	953.18	0.1805	2017: 1,800	12.00	12.00	8.00	8.00	3.20	0.3	1	false	0	false	false	false	1,909.86	2.0	true	60
103	2U	1922+09.301	1923+07.672	98.37	0.0186	2017: 1,800	12.00	12.00	8.00	8.00	0.16	0.3	1	false	0	false	false	false	1,909.86	2.0	true	60
104	2U	1923+07.672	1942+90.110	1,982.44	0.3755	2017: 1,800	12.00	12.00	8.00	8.00	0.16	0.3	1	false	0	false	false	false				
105	2U	1942+90.110	1951+68.332	878.22	0.1663	2017: 1,800	12.00	12.00	8.00	8.00	4.20	0.3	1	false	0	false	false	false				
106	2U	1951+68.332	1991+05.968	3,937.64	0.7458	2017: 1,800	12.00	12.00	8.00	8.00	1.30	0.3	1	false	0	false	false	false				
107	2U	1991+05.968	2014+85.473	2,379.51	0.4507	2017: 1,800	12.00	12.00	8.00	8.00	5.00	0.3	1	false	0	false	false	false				
108	2U	2014+85.473	2044+63.612	2,978.14	0.5640	2017: 1,800	12.00	12.00	8.00	8.00	5.00	0.3	1	false	0	false	false	false				
109	2U	2044+63.612	2061+78.629	1,715.02	0.3248	2017: 1,800	12.00	12.00	8.00	8.00	0.30	0.3	1	false	0	false	false	false				
110	2U	2061+78.629	2070+98.406	919.78	0.1742	2017: 1,800	12.00	12.00	8.00	8.00	0.80	0.3	1	false	0	false	false	false				
111	2U	2070+98.406	2084+39.972	1,341.57	0.2541	2017: 1,800	12.00	12.00	8.00	8.00	0.80	0.3	1	false	0	false	false	false	5,729.58	2.0	true	60
112	2U	2084+39.972	2086+40.102	200.13	0.0379	2017: 1,800	12.00	12.00	8.00	8.00	2.00	0.3	1	false	0	false	false	false	5,729.58	2.0	true	60
113	2U	2086+40.102	2099+74.790	1,334.69	0.2528	2017: 1,800	12.00	12.00	8.00	8.00	2.00	0.3	1	false	0	false	false	false				
114	2U	2099+74.790	2111+43.919	1,169.13	0.2214	2017: 1,800	12.00	12.00	8.00	8.00	1.40	0.3	1	false	0	false	false	false				
115	2U	2111+43.919	2120+81.651	937.73	0.1776	2017: 1,800	12.00	12.00	8.00	8.00	0.40	0.3	1	false	0	false	false	false				
116	2U	2120+81.651	2129+87.830	906.18	0.1716	2017: 1,800	12.00	12.00	8.00	8.00	2.30	0.3	1	false	0	false	false	false				
117	2U	2129+87.830	2140+56.643	1,068.81	0.2024	2017: 1,800	12.00	12.00	8.00	8.00	0.38	0.3	1	false	0	false	false	false				
118	2U	2140+56.643	2142+74.256	217.61	0.0412	2017: 1,800	12.00	12.00	8.00	8.00	0.38	0.3	1	false	0	false	false	false	5,729.58	2.0	true	60
119	2U	2142+74.256	2168+08.627	2,534.37	0.4800	2017: 1,800	12.00	12.00	8.00	8.00	2.00	0.3	1	false	0	false	false	false	5,729.58	2.0	true	60
120	2U	2168+08.627	2182+78.204	1,469.58	0.2783	2017: 1,800	12.00	12.00	8.00	8.00	2.30	0.3	1	false	0	false	false	false	5,729.58	2.0	true	60
121	2U	2182+78.204	2183+26.113	47.91	0.0091	2017: 1,800	12.00	12.00	8.00	8.00	3.00	0.3	1	false	0	false	false	false	5,729.58	2.0	true	60
122	2U	2183+26.113	2199+41.672	1,615.56	0.3060	2017: 1,800	12.00	12.00	8.00	8.00	3.00	0.3	1	false	0	false	false	false				
123	2U	2199+41.672	2201+13.109	171.44	0.0325	2017: 1,800	12.00	12.00	8.00	8.00	1.90	0.3	1	false	0	false	false	false				
124	2U	2201+13.109	2210+46.999	933.89	0.1769	2017: 1,800	12.00	12.00	8.00	8.00	1.90	0.3	1	false	0	false	false	false	2,864.79	2.0	true	60
125	2U	2210+46.999	2224+50.778	1,403.78	0.2659	2017: 1,800	12.00	12.00	8.00	8.00	1.90	0.3	1	false	0	false	false	false				
126	2U	2224+50.778	2238+41.687	1,390.91	0.2634	2017: 1,800	12.00	12.00	8.00	8.00	0.50	0.3	1	false	0	false	false	false				

Seg. No.	Type	Start Location	End Location	Length (ft)	Length (mi)	AADT	Left Lane Width (ft)	Right Lane Width (ft)	Left Shoulder Width (ft)	Right Shoulder Width (ft)	Grade (%)	Driveway Density (driveways/mi)	Hazard Rating	Centerline Rumble Strip	Passing Lanes	TWLT Lane	Lighting	Automated Speed Enforcement	Radius (ft)	Superelevation (%)	Adverse	Design Speed (mph)
127	2U	2238+41.687	2252+38.958	1,397.27	0.2646	2017: 1,800	12.00	12.00	8.00	8.00	2.50	0.3	1	false	0	false	false	false				
128	2U	2252+38.958	2253+13.131	74.17	0.0140	2017: 1,800	12.00	12.00	8.00	8.00	2.50	0.3	1	false	0	false	false	false	2,788.71	2.0	true	60
129	2U	2253+13.131	2267+68.359	1,455.23	0.2756	2017: 1,800	12.00	12.00	8.00	8.00	1.70	0.3	1	false	0	false	false	false	2,788.71	2.0	true	60
130	2U	2267+68.359	2271+18.026	349.67	0.0662	2017: 1,800	12.00	12.00	8.00	8.00	1.70	0.3	1	false	0	false	false	false				
131	2U	2271+18.026	2275+17.825	399.80	0.0757	2017: 1,800	12.00	12.00	8.00	8.00	3.50	0.3	1	false	0	false	false	false				
132	2U	2275+17.825	2283+86.397	868.57	0.1645	2017: 1,800	12.00	12.00	8.00	8.00	3.50	0.3	1	false	0	false	false	false	2,788.71	2.0	true	60
133	2U	2283+86.397	2294+34.169	1,047.77	0.1984	2017: 1,800	12.00	12.00	8.00	8.00	0.60	0.3	1	false	0	false	false	false	2,788.71	2.0	true	60
134	2U	2294+34.169	2297+86.147	351.98	0.0667	2017: 1,800	12.00	12.00	8.00	8.00	0.00	0.3	1	false	0	false	false	false	2,788.71	2.0	true	60
135	2U	2297+86.147	2322+20.021	2,433.87	0.4610	2017: 1,800	12.00	12.00	8.00	8.00	0.00	0.3	1	false	0	false	false	false				
136	2U	2322+20.021	2324+46.955	226.93	0.0430	2017: 1,800	12.00	12.00	8.00	8.00	0.50	0.3	1	false	0	false	false	false				
137	2U	2324+46.955	2328+02.518	355.56	0.0673	2017: 1,800	12.00	12.00	8.00	8.00	0.50	0.3	1	false	0	false	false	false	2,864.09	2.0	true	60
138	2U	2328+02.518	2335+97.505	794.99	0.1506	2017: 1,800	12.00	12.00	8.00	8.00	0.00	0.3	1	false	0	false	false	false	2,864.09	2.0	true	60
139	2U	2335+97.505	2358+28.150	2,230.64	0.4225	2017: 1,800	12.00	12.00	8.00	8.00	0.00	0.3	1	false	0	false	false	false				
140	2U	2358+28.150	2388+01.647	2,973.50	0.5632	2017: 1,800	12.00	12.00	8.00	8.00	0.14	0.3	1	false	0	false	false	false				
141	2U	2388+01.647	2392+62.777	461.13	0.0873	2017: 1,800	12.00	12.00	8.00	8.00	0.14	0.3	1	false	0	false	false	false	1,909.86	2.0	true	60
142	2U	2392+62.777	2393+97.841	135.06	0.0256	2017: 1,800	12.00	12.00	8.00	8.00	1.70	0.3	1	false	0	false	false	false	1,909.86	2.0	true	60
143	2U	2393+97.841	2399+08.519	510.68	0.0967	2017: 1,800	12.00	12.00	8.00	8.00	1.70	0.3	1	false	0	false	false	false				
144	2U	2399+08.519	2406+75.288	766.77	0.1452	2017: 1,800	12.00	12.00	8.00	8.00	1.70	0.3	1	false	0	false	false	false	1,145.92	2.0	true	60
145	2U	2406+75.288	2410+56.262	380.97	0.0722	2017: 1,800	12.00	12.00	8.00	8.00	0.20	0.3	1	false	0	false	false	false	1,145.92	2.0	true	60
146	2U	2410+56.262	2413+31.488	275.23	0.0521	2017: 1,800	12.00	12.00	8.00	8.00	0.20	0.3	1	false	0	false	false	false				
147	2U	2413+31.488	2415+67.769	236.28	0.0447	2017: 1,800	12.00	12.00	8.00	8.00	1.00	0.3	1	false	0	false	false	false				
148	2U	2415+67.769	2417+66.491	198.72	0.0376	2017: 1,800	12.00	12.00	8.00	8.00	1.00	0.3	1	false	0	false	false	false	1,145.91	2.0	true	60
149	2U	2417+66.491	2419+57.000	190.51	0.0361	2017: 1,800	12.00	12.00	8.00	8.00	0.00	0.3	1	false	0	false	false	false	1,145.91	2.0	true	60
150	2U	2419+57.000	2426+42.114	685.11	0.1298	2017: 1,800	12.00	12.00	8.00	8.00	0.00	0.3	1	false	0	false	false	false	1,145.91	2.0	true	60
151	2U	2426+42.114	2459+72.548	3,330.43	0.6308	2017: 1,800	12.00	12.00	8.00	8.00	0.00	0.3	1	false	0	false	false	false				
152	2U	2459+72.548	2466+78.556	706.01	0.1337	2017: 1,800	12.00	12.00	8.00	8.00	0.00	0.3	1	false	0	false	false	false	1,912.94	2.0	true	60
153	2U	2466+78.556	2487+37.299	2,058.74	0.3899	2017: 1,800	12.00	12.00	8.00	8.00	0.00	0.3	1	false	0	false	false	false				

**Table 3. Crash History Highway - Homogeneous Segments (Section 1)**

Seg. No.	Type	Start Location	End Location	Length (ft)	Length(mi)	AADT	Left Lane Width (ft)	Right Lane Width (ft)	Left Shoulder Width (ft)	Right Shoulder Width (ft)	Grade (%)	Driveway Density (driveways/mi)	Hazard Rating	Centerline Rumble Strip	Passing Lanes	TWLT Lane	Lighting	Automated Speed Enforcement	Radius (ft)	Superelevation (%)	Adverse	Design Speed (mph)
1	2U	1327+09.000	1336+44.302	935.30	0.1771	2010-2014: 1,800	12.00	12.00	8.00	8.00	0.00	0.3	1	false	0	false	false	false				
2	2U	1336+44.302	1341+64.474	520.17	0.0985	2010-2014: 1,800	12.00	12.00	8.00	8.00	0.00	0.3	1	false	0	false	false	false	2,864.79	2.0	true	60
3	2U	1341+64.474	1345+88.891	424.42	0.0804	2010-2014: 1,800	12.00	12.00	8.00	8.00	6.00	0.3	1	false	0	false	false	false	2,864.79	2.0	true	60
4	2U	1345+88.891	1349+42.437	353.55	0.0670	2010-2014: 1,800	12.00	12.00	8.00	8.00	6.00	0.3	1	false	0	false	false	false				
5	2U	1349+42.437	1350+43.605	101.17	0.0192	2010-2014: 1,800	12.00	12.00	8.00	8.00	0.00	0.3	1	false	0	false	false	false				
6	2U	1350+43.605	1355+75.006	531.40	0.1006	2010-2014: 1,800	12.00	12.00	8.00	8.00	0.00	0.3	1	false	0	false	false	false	1,432.40	2.0	true	60
7	2U	1355+75.006	1359+98.149	423.14	0.0801	2010-2014: 1,800	12.00	12.00	8.00	8.00	0.00	0.3	1	false	0	false	false	false				
8	2U	1359+98.149	1361+84.449	186.30	0.0353	2010-2014: 1,800	12.00	12.00	8.00	8.00	0.00	0.3	1	false	0	false	false	false	2,864.79	2.0	true	60
9	2U	1361+84.449	1372+13.914	1,029.46	0.1950	2010-2014: 1,800	12.00	12.00	8.00	8.00	2.77	0.3	1	false	0	false	false	false	2,864.79	2.0	true	60
10	2U	1372+13.914	1375+23.561	309.65	0.0587	2010-2014: 1,800	12.00	12.00	8.00	8.00	3.10	0.3	1	false	0	false	false	false	2,864.79	2.0	true	60
11	2U	1375+23.561	1403+14.142	2,790.58	0.5285	2010-2014: 1,800	12.00	12.00	8.00	8.00	3.10	0.3	1	false	0	false	false	false				
12	2U	1403+14.142	1409+56.099	641.96	0.1216	2010-2014: 1,800	12.00	12.00	8.00	8.00	4.20	0.3	1	false	0	false	false	false				
13	2U	1409+56.099	1413+11.581	355.48	0.0673	2010-2014: 1,800	12.00	12.00	8.00	8.00	4.20	0.3	1	false	0	false	false	false	1,909.86	2.0	true	60
14	2U	1413+11.581	1420+94.274	782.69	0.1482	2010-2014: 1,800	12.00	12.00	8.00	8.00	4.57	0.3	1	false	0	false	false	false	1,909.86	2.0	true	60
15	2U	1420+94.274	1425+01.019	406.75	0.0770	2010-2014: 1,800	12.00	12.00	8.00	8.00	4.57	0.3	1	false	0	false	false	false				
16	2U	1425+01.019	1429+54.331	453.31	0.0858	2010-2014: 1,800	12.00	12.00	8.00	8.00	0.50	0.3	1	false	0	false	false	false				
17	2U	1429+54.331	1434+88.047	533.72	0.1011	2010-2014: 1,800	12.00	12.00	8.00	8.00	0.50	0.3	1	false	0	false	false	false	1,909.86	2.0	true	60
18	2U	1434+88.047	1439+38.259	450.21	0.0853	2010-2014: 1,800	12.00	12.00	8.00	8.00	3.40	0.3	1	false	0	false	false	false	1,909.86	2.0	true	60
19	2U	1439+38.259	1442+00.000	261.74	0.0496	2010-2014: 1,800	12.00	12.00	8.00	8.00	3.40	0.3	1	false	0	false	false	false				
20	2U	1442+00.000	1445+85.729	385.73	0.0731	2010-2014: 1,800	12.00	12.00	8.00	8.00	3.40	0.3	1	false	1	false	false	false				
21	2U	1445+85.729	1454+00.000	814.27	0.1542	2010-2014: 1,800	12.00	12.00	8.00	8.00	3.50	0.3	1	false	1	false	false	false				
22	2U	1454+00.000	1457+87.869	387.87	0.0735	2010-2014: 1,800	12.00	12.00	8.00	8.00	3.50	0.3	1	false	0	false	false	false				
23	2U	1457+87.869	1463+32.941	545.07	0.1032	2010-2014: 1,800	12.00	12.00	8.00	8.00	3.50	0.3	1	false	0	false	false	false	2,864.79	2.0	true	60
24	2U	1463+32.941	1468+59.089	526.15	0.0997	2010-2014: 1,800	12.00	12.00	8.00	8.00	3.50	0.3	1	false	0	false	false	false				
25	2U	1468+59.089	1473+71.093	512.00	0.0970	2010-2014: 1,800	12.00	12.00	8.00	8.00	3.50	0.3	1	false	0	false	false	false	1,950.00	2.0	true	60
26	2U	1473+71.093	1477+61.956	390.86	0.0740	2010-2014: 1,800	12.00	12.00	8.00	8.00	0.30	0.3	1	false	0	false	false	false	1,950.00	2.0	true	60
27	2U	1477+61.956	1482+39.570	477.61	0.0905	2010-2014: 1,800	12.00	12.00	8.00	8.00	0.30	0.3	1	false	0	false	false	false				
28	2U	1482+39.570	1490+31.091	791.52	0.1499	2010-2014: 1,800	12.00	12.00	8.00	8.00	0.60	0.3	1	false	0	false	false	false				
29	2U	1490+31.091	1502+99.266	1,268.17	0.2402	2010-2014: 1,800	12.00	12.00	8.00	8.00	0.60	0.3	1	false	0	false	false	false	1,155.00	2.0	true	60
30	2U	1502+99.266	1506+85.128	385.86	0.0731	2010-2014: 1,800	12.00	12.00	8.00	8.00	4.20	0.3	1	false	0	false	false	false	1,155.00	2.0	true	60
31	2U	1506+85.128	1511+36.056	450.93	0.0854	2010-2014: 1,800	12.00	12.00	8.00	8.00	4.20	0.3	1	false	0	false	false	false				
32	2U	1511+36.056	1518+02.293	666.24	0.1262	2010-2014: 1,800	12.00	12.00	8.00	8.00	4.20	0.3	1	false	0	false	false	false	1,145.92	2.0	true	60
33	2U	1518+02.293	1522+56.443	454.15	0.0860	2010-2014: 1,800	12.00	12.00	8.00	8.00	4.20	0.3	1	false	0	false	false	false				
34	2U	1522+56.443	1530+56.765	800.32	0.1516	2010-2014: 1,800	12.00	12.00	8.00	8.00	2.40	0.3	1	false	0	false	false	false				
35	2U	1530+56.765	1532+29.037	172.27	0.0326	2010-2014: 1,800	12.00	12.00	8.00	8.00	2.40	0.3	1	false	0	false	false	false	1,440.00	2.0	true	60
36	2U	1532+29.037	1546+35.066	1,406.03	0.2663	2010-2014: 1,800	12.00	12.00	8.00	8.00	1.55	0.3	1	false	0	false	false	false	1,440.00	2.0	true	60
37	2U	1546+35.066	1555+00.000	864.93	0.1638	2010-2014: 1,800	12.00	12.00	8.00	8.00	1.55	0.3	1	false	0	false	false	false				
38	2U	1555+00.000	1555+42.935	42.94	0.0081	2010-2014: 1,800	12.00	12.00	8.00	8.00	1.55	0.3	1	false	1	false	false	false				
39	2U	1555+42.935	1561+65.077	622.14	0.1178	2010-2014: 1,800	12.00	12.00	8.00	8.00	2.00	0.3	1	false	1	false	false	false				
40	2U	1561+65.077	1568+88.080	723.00	0.1369	2010-2014: 1,800	12.00	12.00	8.00	8.00	2.00	0.3	1	false	1	false	false	false	1,152.00	2.0	true	60

Seg. No.	Type	Start Location	End Location	Length (ft)	Length (m)	AADT	Left Lane Width (ft)	Right Lane Width (ft)	Left Shoulder Width (ft)	Right Shoulder Width (ft)	Grade (%)	Driveway Density (driveways/m <sup>2</sup> )	Hazard Rating	Centerline Rumble Strip	Passing Lanes	TWLT Lane	Lighting	Automated Speed Enforcement	Radius (ft)	Superelevation (%)	Adverse	Design Speed (mph)
41	2U	1568+88.080	1575+49.666	661.59	0.1253	2010-2014: 1,800	12.00	12.00	8.00	8.00	7.00	0.3	1	false	1	false	false	false	1,152.00	2.0	true	60
42	2U	1575+49.666	1579+81.473	431.81	0.0818	2010-2014: 1,800	12.00	12.00	8.00	8.00	7.00	0.3	1	false	1	false	false	false				
43	2U	1579+81.473	1587+62.614	781.14	0.1479	2010-2014: 1,800	12.00	12.00	8.00	8.00	7.00	0.3	1	false	1	false	false	false	881.47	2.0	true	60
44	2U	1587+62.614	1589+20.405	157.79	0.0299	2010-2014: 1,800	12.00	12.00	8.00	8.00	7.00	0.3	1	false	1	false	false	false				
45	2U	1589+20.405	1591+85.378	264.97	0.0502	2010-2014: 1,800	12.00	12.00	8.00	8.00	3.90	0.3	1	false	1	false	false	false				
46	2U	1591+85.378	1598+89.259	703.88	0.1333	2010-2014: 1,800	12.00	12.00	8.00	8.00	3.90	0.3	1	false	1	false	false	false	825.00	2.0	true	60
47	2U	1598+89.259	1604+98.065	608.81	0.1153	2010-2014: 1,800	12.00	12.00	8.00	8.00	7.00	0.3	1	false	1	false	false	false	825.00	2.0	true	60
48	2U	1604+98.065	1609+35.192	437.13	0.0828	2010-2014: 1,800	12.00	12.00	8.00	8.00	7.00	0.3	1	false	1	false	false	false				
49	2U	1609+35.192	1610+00.000	64.81	0.0123	2010-2014: 1,800	12.00	12.00	8.00	8.00	7.00	0.3	1	false	1	false	false	false	1,041.74	2.0	true	60
50	2U	1610+00.000	1614+65.403	465.40	0.0881	2010-2014: 1,800	12.00	12.00	8.00	8.00	7.00	0.3	1	false	0	false	false	false	1,041.74	2.0	true	60
51	2U	1614+65.403	1615+65.837	100.43	0.0190	2010-2014: 1,800	12.00	12.00	8.00	8.00	7.00	0.3	1	false	0	false	false	false				
52	2U	1615+65.837	1623+55.342	789.50	0.1495	2010-2014: 1,800	12.00	12.00	8.00	8.00	0.70	0.3	1	false	0	false	false	false				
53	2U	1623+55.342	1627+06.536	351.19	0.0665	2010-2014: 1,800	12.00	12.00	8.00	8.00	0.70	0.3	1	false	0	false	false	false	3,819.72	2.0	true	60
54	2U	1627+06.536	1634+67.324	760.79	0.1441	2010-2014: 1,800	12.00	12.00	8.00	8.00	3.30	0.3	1	false	0	false	false	false	3,819.72	2.0	true	60
55	2U	1634+67.324	1643+43.433	876.11	0.1659	2010-2014: 1,800	12.00	12.00	8.00	8.00	3.30	0.3	1	false	0	false	false	false				
56	2U	1643+43.433	1658+40.396	1,496.96	0.2835	2010-2014: 1,800	12.00	12.00	8.00	8.00	3.30	0.3	1	false	0	false	false	false	2,546.48	2.0	true	60
57	2U	1658+40.396	1662+05.617	365.22	0.0692	2010-2014: 1,800	12.00	12.00	8.00	8.00	0.70	0.3	1	false	0	false	false	false	2,546.48	2.0	true	60
58	2U	1662+05.617	1671+65.038	959.42	0.1817	2010-2014: 1,800	12.00	12.00	8.00	8.00	0.70	0.3	1	false	0	false	false	false				
59	2U	1671+65.038	1674+56.874	291.84	0.0553	2010-2014: 1,800	12.00	12.00	8.00	8.00	1.30	0.3	1	false	0	false	false	false				
60	2U	1674+56.874	1681+00.000	643.13	0.1218	2010-2014: 1,800	12.00	12.00	8.00	8.00	1.30	0.3	1	false	0	false	false	false	2,864.79	2.0	true	60
61	2U	1681+00.000	1684+84.121	384.12	0.0727	2010-2014: 1,800	12.00	12.00	8.00	8.00	1.30	0.3	1	false	1	false	false	false	2,864.79	2.0	true	60
62	2U	1684+84.121	1689+55.548	471.43	0.0893	2010-2014: 1,800	12.00	12.00	8.00	8.00	1.30	0.3	1	false	1	false	false	false				
63	2U	1689+55.548	1696+91.231	735.68	0.1393	2010-2014: 1,800	12.00	12.00	8.00	8.00	1.30	0.3	1	false	1	false	false	false	2,291.83	2.0	true	60
64	2U	1696+91.231	1697+38.184	46.95	0.0089	2010-2014: 1,800	12.00	12.00	8.00	8.00	0.60	0.3	1	false	1	false	false	false	2,291.83	2.0	true	60
65	2U	1697+38.184	1703+52.875	614.69	0.1164	2010-2014: 1,800	12.00	12.00	8.00	8.00	0.60	0.3	1	false	1	false	false	false				
66	2U	1703+52.875	1708+54.649	501.77	0.0950	2010-2014: 1,800	12.00	12.00	8.00	8.00	0.60	0.3	1	false	1	false	false	false	3,819.72	2.0	true	60
67	2U	1708+54.649	1713+92.335	537.69	0.1018	2010-2014: 1,800	12.00	12.00	8.00	8.00	4.00	0.3	1	false	1	false	false	false	3,819.72	2.0	true	60
68	2U	1713+92.335	1716+89.463	297.13	0.0563	2010-2014: 1,800	12.00	12.00	8.00	8.00	4.00	0.3	1	false	1	false	false	false				
69	2U	1716+89.463	1728+08.381	1,118.92	0.2119	2010-2014: 1,800	12.00	12.00	8.00	8.00	0.50	0.3	1	false	1	false	false	false				
70	2U	1728+08.381	1731+17.025	308.64	0.0585	2010-2014: 1,800	12.00	12.00	8.00	8.00	5.30	0.3	1	false	1	false	false	false				
71	2U	1731+17.025	1736+82.212	565.19	0.1070	2010-2014: 1,800	12.00	12.00	8.00	8.00	5.30	0.3	1	false	1	false	false	false	2,150.00	2.0	true	60
72	2U	1736+82.212	1739+00.000	217.79	0.0413	2010-2014: 1,800	12.00	12.00	8.00	8.00	5.30	0.3	1	false	1	false	false	false				
73	2U	1739+00.000	1749+79.705	1,079.70	0.2045	2010-2014: 1,800	12.00	12.00	8.00	8.00	5.30	0.3	1	false	0	false	false	false				
74	2U	1749+79.705	1750+54.678	74.97	0.0142	2010-2014: 1,800	12.00	12.00	8.00	8.00	5.30	0.3	1	false	0	false	false	false	1,950.00	2.0	true	60
75	2U	1750+54.678	1754+00.000	345.32	0.0654	2010-2014: 1,800	12.00	12.00	8.00	8.00	4.60	0.3	1	false	0	false	false	false	1,950.00	2.0	true	60
76	2U	1754+00.000	1756+47.361	247.36	0.0469	2010-2014: 1,800	12.00	12.00	8.00	8.00	4.60	0.3	1	false	1	false	false	false	1,950.00	2.0	true	60
77	2U	1756+47.361	1761+94.171	546.81	0.1036	2010-2014: 1,800	12.00	12.00	8.00	8.00	4.60	0.3	1	false	1	false	false	false				
78	2U	1761+94.171	1764+68.438	274.27	0.0519	2010-2014: 1,800	12.00	12.00	8.00	8.00	4.60	0.3	1	false	1	false	false	false	5,800.00	2.0	true	60
79	2U	1764+68.438	1769+37.986	469.55	0.0889	2010-2014: 1,800	12.00	12.00	8.00	8.00	5.00	0.3	1	false	1	false	false	false	5,800.00	2.0	true	60
80	2U	1769+37.986	1786+03.032	1,665.05	0.3154	2010-2014: 1,800	12.00	12.00	8.00	8.00	5.00	0.3	1	false	1	false	false	false				
81	2U	1786+03.032	1796+26.415	1,023.38	0.1938	2010-2014: 1,800	12.00	12.00	8.00	8.00	0.30	0.3	1	false	1	false	false	false				
82	2U	1796+26.415	1801+11.457	485.04	0.0919	2010-2014: 1,800	12.00	12.00	8.00	8.00	0.30	0.3	1	false	1	false	false	false	5,729.58	2.0	true	60
83	2U	1801+11.457	1803+66.390	254.93	0.0483	2010-2014: 1,800	12.00	12.00	8.00	8.00	0.30	0.3	1	false	1	false	false	false				



Seg. No.	Type	Start Location	End Location	Length (ft)	Length (m)	AADT	Left Lane Width (ft)	Right Lane Width (ft)	Left Shoulder Width (ft)	Right Shoulder Width (ft)	Grade (%)	Driveway Density (driveways/m <sup>2</sup> )	Hazard Rating	Centerline Rumble Strip	Passing Lanes	TWLT Lane	Lighting	Automated Speed Enforcement	Radius (ft)	Superelevation (%)	Adverse	Design Speed (mph)
84	2U	1803+66.390	1814+09.517	1,043.13	0.1976	2010-2014: 1,800	12.00	12.00	8.00	8.00	4.90	0.3	1	false	1	false	false	false				
85	2U	1814+09.517	1819+97.464	587.95	0.1114	2010-2014: 1,800	12.00	12.00	8.00	8.00	4.90	0.3	1	false	1	false	false	false	1,450.00	2.0	true	60
86	2U	1819+97.464	1820+48.062	50.60	0.0096	2010-2014: 1,800	12.00	12.00	8.00	8.00	4.90	0.3	1	false	1	false	false	false				
87	2U	1820+48.062	1824+53.898	405.84	0.0769	2010-2014: 1,800	12.00	12.00	8.00	8.00	1.70	0.3	1	false	1	false	false	false				
88	2U	1824+53.898	1826+89.465	235.57	0.0446	2010-2014: 1,800	12.00	12.00	8.00	8.00	1.70	0.3	1	false	1	false	false	false	3,000.00	2.0	true	60
89	2U	1826+89.465	1830+41.880	352.42	0.0668	2010-2014: 1,800	12.00	12.00	8.00	8.00	5.00	0.3	1	false	1	false	false	false	3,000.00	2.0	true	60
90	2U	1830+41.880	1836+58.064	616.18	0.1167	2010-2014: 1,800	12.00	12.00	8.00	8.00	5.00	0.3	1	false	1	false	false	false				
91	2U	1836+58.064	1841+90.386	532.32	0.1008	2010-2014: 1,800	12.00	12.00	8.00	8.00	5.00	0.3	1	false	1	false	false	false	1,160.00	2.0	true	60
92	2U	1841+90.386	1844+74.496	284.11	0.0538	2010-2014: 1,800	12.00	12.00	8.00	8.00	4.00	0.3	1	false	1	false	false	false	1,160.00	2.0	true	60
93	2U	1844+74.496	1849+15.104	440.61	0.0834	2010-2014: 1,800	12.00	12.00	8.00	8.00	4.00	0.3	1	false	1	false	false	false				
94	2U	1849+15.104	1858+04.945	889.84	0.1685	2010-2014: 1,800	12.00	12.00	8.00	8.00	4.00	0.3	1	false	1	false	false	false	825.00	2.0	true	60
95	2U	1858+04.945	1869+49.895	1,144.95	0.2168	2010-2014: 1,800	12.00	12.00	8.00	8.00	4.00	0.3	1	false	1	false	false	false				
96	2U	1869+49.895	1875+20.742	570.85	0.1081	2010-2014: 1,800	12.00	12.00	8.00	8.00	4.00	0.3	1	false	1	false	false	false	1,909.86	2.0	true	60
97	2U	1875+20.742	1887+50.279	1,229.54	0.2329	2010-2014: 1,800	12.00	12.00	8.00	8.00	4.00	0.3	1	false	1	false	false	false				
98	2U	1887+50.279	1899+00.000	1,149.72	0.2177	2010-2014: 1,800	12.00	12.00	8.00	8.00	3.20	0.3	1	false	1	false	false	false				
99	2U	1899+00.000	1902+52.815	352.81	0.0668	2010-2014: 1,800	12.00	12.00	8.00	8.00	3.20	0.3	1	false	0	false	false	false				
100	2U	1902+52.815	1908+15.543	562.73	0.1066	2010-2014: 1,800	12.00	12.00	8.00	8.00	3.20	0.3	1	false	0	false	false	false	1,980.00	2.0	true	60
101	2U	1908+15.543	1912+56.122	440.58	0.0834	2010-2014: 1,800	12.00	12.00	8.00	8.00	3.20	0.3	1	false	0	false	false	false				
102	2U	1912+56.122	1922+09.301	953.18	0.1805	2010-2014: 1,800	12.00	12.00	8.00	8.00	3.20	0.3	1	false	0	false	false	false	1,909.86	2.0	true	60
103	2U	1922+09.301	1923+07.672	98.37	0.0186	2010-2014: 1,800	12.00	12.00	8.00	8.00	0.16	0.3	1	false	0	false	false	false	1,909.86	2.0	true	60
104	2U	1923+07.672	1942+90.110	1,982.44	0.3755	2010-2014: 1,800	12.00	12.00	8.00	8.00	0.16	0.3	1	false	0	false	false	false				
105	2U	1942+90.110	1951+68.332	878.22	0.1663	2010-2014: 1,800	12.00	12.00	8.00	8.00	4.20	0.3	1	false	0	false	false	false				
106	2U	1951+68.332	1991+05.968	3,937.64	0.7458	2010-2014: 1,800	12.00	12.00	8.00	8.00	1.30	0.3	1	false	0	false	false	false				
107	2U	1991+05.968	2014+85.473	2,379.51	0.4507	2010-2014: 1,800	12.00	12.00	8.00	8.00	5.00	0.3	1	false	0	false	false	false				
108	2U	2014+85.473	2044+63.612	2,978.14	0.5640	2010-2014: 1,800	12.00	12.00	8.00	8.00	5.00	0.3	1	false	0	false	false	false				
109	2U	2044+63.612	2061+78.629	1,715.02	0.3248	2010-2014: 1,800	12.00	12.00	8.00	8.00	0.30	0.3	1	false	0	false	false	false				
110	2U	2061+78.629	2070+98.406	919.78	0.1742	2010-2014: 1,800	12.00	12.00	8.00	8.00	0.80	0.3	1	false	0	false	false	false				
111	2U	2070+98.406	2084+39.972	1,341.57	0.2541	2010-2014: 1,800	12.00	12.00	8.00	8.00	0.80	0.3	1	false	0	false	false	false	5,729.58	2.0	true	60
112	2U	2084+39.972	2086+40.102	200.13	0.0379	2010-2014: 1,800	12.00	12.00	8.00	8.00	2.00	0.3	1	false	0	false	false	false	5,729.58	2.0	true	60
113	2U	2086+40.102	2099+74.790	1,334.69	0.2528	2010-2014: 1,800	12.00	12.00	8.00	8.00	2.00	0.3	1	false	0	false	false	false				
114	2U	2099+74.790	2111+43.919	1,169.13	0.2214	2010-2014: 1,800	12.00	12.00	8.00	8.00	1.40	0.3	1	false	0	false	false	false				
115	2U	2111+43.919	2120+81.651	937.73	0.1776	2010-2014: 1,800	12.00	12.00	8.00	8.00	0.40	0.3	1	false	0	false	false	false				
116	2U	2120+81.651	2129+87.830	906.18	0.1716	2010-2014: 1,800	12.00	12.00	8.00	8.00	2.30	0.3	1	false	0	false	false	false				
117	2U	2129+87.830	2140+56.643	1,068.81	0.2024	2010-2014: 1,800	12.00	12.00	8.00	8.00	0.38	0.3	1	false	0	false	false	false				
118	2U	2140+56.643	2142+74.256	217.61	0.0412	2010-2014: 1,800	12.00	12.00	8.00	8.00	0.38	0.3	1	false	0	false	false	false	5,729.58	2.0	true	60
119	2U	2142+74.256	2168+08.627	2,534.37	0.4800	2010-2014: 1,800	12.00	12.00	8.00	8.00	2.00	0.3	1	false	0	false	false	false	5,729.58	2.0	true	60
120	2U	2168+08.627	2182+78.204	1,469.58	0.2783	2010-2014: 1,800	12.00	12.00	8.00	8.00	2.30	0.3	1	false	0	false	false	false	5,729.58	2.0	true	60
121	2U	2182+78.204	2183+26.113	47.91	0.0091	2010-2014: 1,800	12.00	12.00	8.00	8.00	3.00	0.3	1	false	0	false	false	false	5,729.58	2.0	true	60
122	2U	2183+26.113	2199+41.672	1,615.56	0.3060	2010-2014: 1,800	12.00	12.00	8.00	8.00	3.00	0.3	1	false	0	false	false	false				
123	2U	2199+41.672	2201+13.109	171.44	0.0325	2010-2014: 1,800	12.00	12.00	8.00	8.00	1.90	0.3	1	false	0	false	false	false				
124	2U	2201+13.109	2210+46.999	933.89	0.1769	2010-2014: 1,800	12.00	12.00	8.00	8.00	1.90	0.3	1	false	0	false	false	false	2,864.79	2.0	true	60
125	2U	2210+46.999	2224+50.778	1,403.78	0.2659	2010-2014: 1,800	12.00	12.00	8.00	8.00	1.90	0.3	1	false	0	false	false	false				
126	2U	2224+50.778	2238+41.687	1,390.91	0.2634	2010-2014: 1,800	12.00	12.00	8.00	8.00	0.50	0.3	1	false	0	false	false	false				

Seg. No.	Type	Start Location	End Location	Length (ft)	Length (mi)	AADT	Left Lane Width (ft)	Right Lane Width (ft)	Left Shoulder Width (ft)	Right Shoulder Width (ft)	Grade (%)	Driveway Density (driveways/mi)	Hazard Rating	Centerline Rumble Strip	Passing Lanes	TWLT Lane	Lighting	Automated Speed Enforcement	Radius (ft)	Superelevation (%)	Adverse	Design Speed (mph)
127	2U	2238+41.687	2252+38.958	1,397.27	0.2646	2010-2014: 1,800	12.00	12.00	8.00	8.00	2.50	0.3	1	false	0	false	false	false				
128	2U	2252+38.958	2253+13.131	74.17	0.0140	2010-2014: 1,800	12.00	12.00	8.00	8.00	2.50	0.3	1	false	0	false	false	false	2,788.71	2.0	true	60
129	2U	2253+13.131	2267+68.359	1,455.23	0.2756	2010-2014: 1,800	12.00	12.00	8.00	8.00	1.70	0.3	1	false	0	false	false	false	2,788.71	2.0	true	60
130	2U	2267+68.359	2271+18.026	349.67	0.0662	2010-2014: 1,800	12.00	12.00	8.00	8.00	1.70	0.3	1	false	0	false	false	false				
131	2U	2271+18.026	2275+17.825	399.80	0.0757	2010-2014: 1,800	12.00	12.00	8.00	8.00	3.50	0.3	1	false	0	false	false	false				
132	2U	2275+17.825	2283+86.397	868.57	0.1645	2010-2014: 1,800	12.00	12.00	8.00	8.00	3.50	0.3	1	false	0	false	false	false	2,788.71	2.0	true	60
133	2U	2283+86.397	2294+34.169	1,047.77	0.1984	2010-2014: 1,800	12.00	12.00	8.00	8.00	0.60	0.3	1	false	0	false	false	false	2,788.71	2.0	true	60
134	2U	2294+34.169	2297+86.147	351.98	0.0667	2010-2014: 1,800	12.00	12.00	8.00	8.00	0.00	0.3	1	false	0	false	false	false	2,788.71	2.0	true	60
135	2U	2297+86.147	2322+20.021	2,433.87	0.4610	2010-2014: 1,800	12.00	12.00	8.00	8.00	0.00	0.3	1	false	0	false	false	false				
136	2U	2322+20.021	2324+46.955	226.93	0.0430	2010-2014: 1,800	12.00	12.00	8.00	8.00	0.50	0.3	1	false	0	false	false	false				
137	2U	2324+46.955	2328+02.518	355.56	0.0673	2010-2014: 1,800	12.00	12.00	8.00	8.00	0.50	0.3	1	false	0	false	false	false	2,864.09	2.0	true	60
138	2U	2328+02.518	2335+97.505	794.99	0.1506	2010-2014: 1,800	12.00	12.00	8.00	8.00	0.00	0.3	1	false	0	false	false	false	2,864.09	2.0	true	60
139	2U	2335+97.505	2358+28.150	2,230.64	0.4225	2010-2014: 1,800	12.00	12.00	8.00	8.00	0.00	0.3	1	false	0	false	false	false				
140	2U	2358+28.150	2388+01.647	2,973.50	0.5632	2010-2014: 1,800	12.00	12.00	8.00	8.00	0.14	0.3	1	false	0	false	false	false				
141	2U	2388+01.647	2392+62.777	461.13	0.0873	2010-2014: 1,800	12.00	12.00	8.00	8.00	0.14	0.3	1	false	0	false	false	false	1,909.86	2.0	true	60
142	2U	2392+62.777	2393+97.841	135.06	0.0256	2010-2014: 1,800	12.00	12.00	8.00	8.00	1.70	0.3	1	false	0	false	false	false	1,909.86	2.0	true	60
143	2U	2393+97.841	2399+08.519	510.68	0.0967	2010-2014: 1,800	12.00	12.00	8.00	8.00	1.70	0.3	1	false	0	false	false	false				
144	2U	2399+08.519	2406+75.288	766.77	0.1452	2010-2014: 1,800	12.00	12.00	8.00	8.00	1.70	0.3	1	false	0	false	false	false	1,145.92	2.0	true	60
145	2U	2406+75.288	2410+56.262	380.97	0.0722	2010-2014: 1,800	12.00	12.00	8.00	8.00	0.20	0.3	1	false	0	false	false	false	1,145.92	2.0	true	60
146	2U	2410+56.262	2413+31.488	275.23	0.0521	2010-2014: 1,800	12.00	12.00	8.00	8.00	0.20	0.3	1	false	0	false	false	false				
147	2U	2413+31.488	2415+67.769	236.28	0.0447	2010-2014: 1,800	12.00	12.00	8.00	8.00	1.00	0.3	1	false	0	false	false	false				
148	2U	2415+67.769	2417+66.491	198.72	0.0376	2010-2014: 1,800	12.00	12.00	8.00	8.00	1.00	0.3	1	false	0	false	false	false	1,145.91	2.0	true	60
149	2U	2417+66.491	2419+57.000	190.51	0.0361	2010-2014: 1,800	12.00	12.00	8.00	8.00	0.00	0.3	1	false	0	false	false	false	1,145.91	2.0	true	60
150	2U	2419+57.000	2426+42.114	685.11	0.1298	2010-2014: 1,800	12.00	12.00	8.00	8.00	0.00	0.3	1	false	0	false	false	false	1,145.91	2.0	true	60
151	2U	2426+42.114	2459+72.548	3,330.43	0.6308	2010-2014: 1,800	12.00	12.00	8.00	8.00	0.00	0.3	1	false	0	false	false	false				
152	2U	2459+72.548	2466+78.556	706.01	0.1337	2010-2014: 1,800	12.00	12.00	8.00	8.00	0.00	0.3	1	false	0	false	false	false	1,912.94	2.0	true	60
153	2U	2466+78.556	2487+37.299	2,058.74	0.3899	2010-2014: 1,800	12.00	12.00	8.00	8.00	0.00	0.3	1	false	0	false	false	false				

**Table 4. Expected Highway Crash Rates and Frequencies (Section 1)**

<b>First Year of Analysis</b>	2017
<b>Last Year of Analysis</b>	2017
<b>Evaluated Length (mi)</b>	21.9751
<b>Average Future Road AADT (vpd)</b>	1,800
<b>Expected Crashes</b>	
<b>Total Crashes</b>	9.15
<b>Fatal and Injury Crashes</b>	3.16
<b>Property-Damage-Only Crashes</b>	5.99
<b>Percent of Total Expected Crashes</b>	
<b>Percent Fatal and Injury Crashes (%)</b>	35
<b>Percent Property-Damage-Only Crashes (%)</b>	65
<b>Expected Crash Rate</b>	
<b>Crash Rate (crashes/mi/yr)</b>	0.4164
<b>Fatal and Injury Crash Rate (crashes/mi/yr)</b>	0.1440
<b>Property-Damage-Only Crash Rate (crashes/mi/yr)</b>	0.2725
<b>Expected Travel Crash Rate</b>	
<b>Total Travel (million veh-mi)</b>	14.44
<b>Travel Crash Rate (crashes/million veh-mi)</b>	0.63
<b>Travel Fatal and Injury Crash Rate (crashes/million veh-mi)</b>	0.22
<b>Travel Property-Damage-Only Crash Rate (crashes/million veh-mi)</b>	0.42

**Table 5. Expected Crash Frequencies and Rates by Highway Segment (Section 1)**

<b>Segment Number/Intersection Name/Cross Road</b>	<b>Start Location</b>	<b>End Location</b>	<b>Length (mi)</b>	<b>Expected No. Crashes for Evaluation Period</b>	<b>Crash Rate (crashes/mi/yr)</b>	<b>Travel Crash Rate (crashes/million veh-mi)</b>
1	1327+09.000	1336+44.302	0.1771	0.048	0.2683	0.41
2	1336+44.302	1341+64.474	0.0985	0.032	0.3215	0.49
3	1341+64.474	1345+88.891	0.0804	0.027	0.3407	0.52
4	1345+88.891	1349+42.437	0.0670	0.019	0.2861	0.43
5	1349+42.437	1350+43.605	0.0192	0.005	0.2683	0.41
6	1350+43.605	1355+75.006	0.1006	0.037	0.3716	0.57
7	1355+75.006	1359+98.149	0.0801	0.021	0.2683	0.41
8	1359+98.149	1361+84.449	0.0353	0.011	0.3144	0.48
9	1361+84.449	1372+13.914	0.1950	0.061	0.3144	0.48
10	1372+13.914	1375+23.561	0.0586	0.020	0.3335	0.51
11	1375+23.561	1403+14.142	0.5285	0.151	0.2861	0.43

Segment Number/Intersection Name/Cross Road	Start Location	End Location	Length (mi)	Expected No. Crashes for Evaluation Period	Crash Rate (crashes/mi/yr)	Travel Crash Rate (crashes/million veh-mi)
12	1403+14.142	1409+56.099	0.1216	0.035	0.2861	0.43
13	1409+56.099	1413+11.581	0.0673	0.024	0.3503	0.53
14	1413+11.581	1420+94.274	0.1482	0.052	0.3503	0.53
15	1420+94.274	1425+01.019	0.0770	0.022	0.2861	0.43
16	1425+01.019	1429+54.331	0.0859	0.023	0.2683	0.41
17	1429+54.331	1434+88.047	0.1011	0.034	0.3344	0.51
18	1434+88.047	1439+38.259	0.0853	0.030	0.3539	0.54
19	1439+38.259	1442+00.000	0.0496	0.014	0.2861	0.43
20	1442+00.000	1445+85.729	0.0731	0.017	0.2344	0.36
21	1445+85.729	1454+00.000	0.1542	0.036	0.2344	0.36
22	1454+00.000	1457+87.869	0.0735	0.021	0.2861	0.43
23	1457+87.869	1463+32.941	0.1032	0.036	0.3540	0.54
24	1463+32.941	1468+59.089	0.0996	0.029	0.2861	0.43
25	1468+59.089	1473+71.093	0.0970	0.035	0.3556	0.54
26	1473+71.093	1477+61.956	0.0740	0.025	0.3361	0.51
27	1477+61.956	1482+39.570	0.0905	0.088	0.9685	1.47
28	1482+39.570	1490+31.091	0.1499	0.040	0.2683	0.41
29	1490+31.091	1502+99.266	0.2402	0.081	0.3359	0.51
30	1502+99.266	1506+85.128	0.0731	0.026	0.3554	0.54
31	1506+85.128	1511+36.056	0.0854	0.024	0.2861	0.43
32	1511+36.056	1518+02.293	0.1262	0.142	1.1234	1.71
33	1518+02.293	1522+56.443	0.0860	0.092	1.0712	1.63
34	1522+56.443	1530+56.765	0.1516	0.041	0.2683	0.41
35	1530+56.765	1532+29.037	0.0326	0.011	0.3319	0.51
36	1532+29.037	1546+35.066	0.2663	0.088	0.3319	0.51
37	1546+35.066	1555+00.000	0.1638	0.044	0.2683	0.41
38	1555+00.000	1555+42.935	0.0081	0.002	0.2186	0.33
39	1555+42.935	1561+65.077	0.1178	0.026	0.2186	0.33
40	1561+65.077	1568+88.080	0.1369	0.039	0.2843	0.43
41	1568+88.080	1575+49.666	0.1253	0.039	0.3130	0.48
42	1575+49.666	1579+81.473	0.0818	0.020	0.2435	0.37
43	1579+81.473	1587+62.614	0.1479	0.134	0.9043	1.38
44	1587+62.614	1589+20.405	0.0299	0.007	0.2435	0.37
45	1589+20.405	1591+85.378	0.0502	0.012	0.2344	0.36
46	1591+85.378	1598+89.259	0.1333	0.042	0.3157	0.48
47	1598+89.259	1604+98.065	0.1153	0.038	0.3263	0.50
48	1604+98.065	1609+35.192	0.0828	0.020	0.2435	0.37
49	1609+35.192	1610+00.000	0.0123	0.004	0.3624	0.55
50	1610+00.000	1614+65.403	0.0881	0.037	0.4229	0.64
51	1614+65.403	1615+65.837	0.0190	0.006	0.2963	0.45
52	1615+65.837	1623+55.342	0.1495	0.040	0.2683	0.41
53	1623+55.342	1627+06.536	0.0665	0.021	0.3108	0.47
54	1627+06.536	1634+67.324	0.1441	0.125	0.8698	1.32
55	1634+67.324	1643+43.433	0.1659	0.115	0.6931	1.05
56	1643+43.433	1658+40.396	0.2835	0.173	0.6112	0.93
57	1658+40.396	1662+05.617	0.0692	0.022	0.3145	0.48
58	1662+05.617	1671+65.038	0.1817	0.049	0.2683	0.41
59	1671+65.038	1674+56.874	0.0553	0.078	1.4141	2.15
60	1674+56.874	1681+00.000	0.1218	0.190	1.5600	2.37
61	1681+00.000	1684+84.121	0.0728	0.019	0.2650	0.40
62	1684+84.121	1689+55.548	0.0893	0.019	0.2186	0.33

Segment Number/Intersection Name/Cross Road	Start Location	End Location	Length (mi)	Expected No. Crashes for Evaluation Period	Crash Rate (crashes/mi/yr)	Travel Crash Rate (crashes/million veh-mi)
63	1689+55.548	1696+91.231	0.1393	0.235	1.6878	2.57
64	1696+91.231	1697+38.184	0.0089	0.003	0.2775	0.42
65	1697+38.184	1703+52.875	0.1164	0.077	0.6616	1.01
66	1703+52.875	1708+54.649	0.0950	0.085	0.8964	1.36
67	1708+54.649	1713+92.335	0.1018	0.028	0.2747	0.42
68	1713+92.335	1716+89.463	0.0563	0.013	0.2344	0.36
69	1716+89.463	1728+08.381	0.2119	0.046	0.2186	0.33
70	1728+08.381	1731+17.025	0.0585	0.014	0.2344	0.36
71	1731+17.025	1736+82.212	0.1070	0.033	0.3084	0.47
72	1736+82.212	1739+00.000	0.0412	0.010	0.2344	0.36
73	1739+00.000	1749+79.705	0.2045	0.126	0.6163	0.94
74	1749+79.705	1750+54.678	0.0142	0.005	0.3652	0.56
75	1750+54.678	1754+00.000	0.0654	0.024	0.3652	0.56
76	1754+00.000	1756+47.361	0.0468	0.014	0.3070	0.47
77	1756+47.361	1761+94.171	0.1036	0.024	0.2344	0.36
78	1761+94.171	1764+68.438	0.0519	0.014	0.2690	0.41
79	1764+68.438	1769+37.986	0.0889	0.024	0.2690	0.41
80	1769+37.986	1786+03.032	0.3153	0.074	0.2344	0.36
81	1786+03.032	1796+26.415	0.1938	0.042	0.2186	0.33
82	1796+26.415	1801+11.457	0.0919	0.024	0.2576	0.39
83	1801+11.457	1803+66.390	0.0483	0.011	0.2186	0.33
84	1803+66.390	1814+09.517	0.1976	0.102	0.5143	0.78
85	1814+09.517	1819+97.464	0.1114	0.036	0.3262	0.50
86	1819+97.464	1820+48.062	0.0096	0.002	0.2344	0.36
87	1820+48.062	1824+53.898	0.0769	0.017	0.2186	0.33
88	1824+53.898	1826+89.465	0.0446	0.012	0.2742	0.42
89	1826+89.465	1830+41.880	0.0667	0.019	0.2922	0.45
90	1830+41.880	1836+58.064	0.1167	0.083	0.7083	1.08
91	1836+58.064	1841+90.386	0.1008	0.032	0.3213	0.49
92	1841+90.386	1844+74.496	0.0538	0.017	0.3213	0.49
93	1844+74.496	1849+15.104	0.0834	0.020	0.2344	0.36
94	1849+15.104	1858+04.945	0.1685	0.056	0.3340	0.51
95	1858+04.945	1869+49.895	0.2168	0.051	0.2344	0.36
96	1869+49.895	1875+20.742	0.1081	0.108	0.9978	1.52
97	1875+20.742	1887+50.279	0.2329	0.055	0.2344	0.36
98	1887+50.279	1899+00.000	0.2178	0.106	0.4884	0.74
99	1899+00.000	1902+52.815	0.0668	0.019	0.2861	0.43
100	1902+52.815	1908+15.543	0.1066	0.127	1.1932	1.82
101	1908+15.543	1912+56.122	0.0834	0.091	1.0954	1.67
102	1912+56.122	1922+09.301	0.1805	0.064	0.3522	0.54
103	1922+09.301	1923+07.672	0.0186	0.006	0.3327	0.51
104	1923+07.672	1942+90.110	0.3755	0.101	0.2683	0.41
105	1942+90.110	1951+68.332	0.1663	0.115	0.6921	1.05
106	1951+68.332	1991+05.968	0.7458	0.390	0.5231	0.80
107	1991+05.968	2014+85.473	0.4507	0.129	0.2861	0.43
108	2014+85.473	2044+63.612	0.5640	0.161	0.2861	0.43
109	2044+63.612	2061+78.629	0.3248	0.087	0.2683	0.41
110	2061+78.629	2070+98.406	0.1742	0.047	0.2683	0.41
111	2070+98.406	2084+39.972	0.2541	0.076	0.2995	0.46
112	2084+39.972	2086+40.102	0.0379	0.011	0.2995	0.46
113	2086+40.102	2099+74.790	0.2528	0.068	0.2683	0.41

Segment Number/Intersection Name/Cross Road	Start Location	End Location	Length (mi)	Expected No. Crashes for Evaluation Period	Crash Rate (crashes/mi/yr)	Travel Crash Rate (crashes/million veh-mi)
114	2099+74.790	2111+43.919	0.2214	0.123	0.5544	0.84
115	2111+43.919	2120+81.651	0.1776	0.111	0.6249	0.95
116	2120+81.651	2129+87.830	0.1716	0.046	0.2683	0.41
117	2129+87.830	2140+56.643	0.2024	0.054	0.2683	0.41
118	2140+56.643	2142+74.256	0.0412	0.012	0.2957	0.45
119	2142+74.256	2168+08.627	0.4800	0.142	0.2957	0.45
120	2168+08.627	2182+78.204	0.2783	0.082	0.2957	0.45
121	2182+78.204	2183+26.113	0.0091	0.003	0.2957	0.45
122	2183+26.113	2199+41.672	0.3060	0.272	0.8893	1.35
123	2199+41.672	2201+13.109	0.0325	0.009	0.2683	0.41
124	2201+13.109	2210+46.999	0.1769	0.057	0.3217	0.49
125	2210+46.999	2224+50.778	0.2659	0.135	0.5065	0.77
126	2224+50.778	2238+41.687	0.2634	0.134	0.5088	0.77
127	2238+41.687	2252+38.958	0.2646	0.071	0.2683	0.41
128	2252+38.958	2253+13.131	0.0140	0.004	0.3147	0.48
129	2253+13.131	2267+68.359	0.2756	0.087	0.3147	0.48
130	2267+68.359	2271+18.026	0.0662	0.018	0.2683	0.41
131	2271+18.026	2275+17.825	0.0757	0.022	0.2861	0.43
132	2275+17.825	2283+86.397	0.1645	0.054	0.3298	0.50
133	2283+86.397	2294+34.169	0.1984	0.062	0.3108	0.47
134	2294+34.169	2297+86.147	0.0667	0.021	0.3108	0.47
135	2297+86.147	2322+20.021	0.4610	0.250	0.5431	0.83
136	2322+20.021	2324+46.955	0.0430	0.011	0.2683	0.41
137	2324+46.955	2328+02.518	0.0673	0.097	1.4332	2.18
138	2328+02.518	2335+97.505	0.1506	0.123	0.8169	1.24
139	2335+97.505	2358+28.150	0.4225	0.113	0.2683	0.41
140	2358+28.150	2388+01.647	0.5632	0.278	0.4933	0.75
141	2388+01.647	2392+62.777	0.0873	0.113	1.2979	1.98
142	2392+62.777	2393+97.841	0.0256	0.009	0.3506	0.53
143	2393+97.841	2399+08.519	0.0967	0.026	0.2683	0.41
144	2399+08.519	2406+75.288	0.1452	0.050	0.3472	0.53
145	2406+75.288	2410+56.262	0.0722	0.025	0.3472	0.53
146	2410+56.262	2413+31.488	0.0521	0.014	0.2683	0.41
147	2413+31.488	2415+67.769	0.0448	0.012	0.2683	0.41
148	2415+67.769	2417+66.491	0.0376	0.096	2.5415	3.87
149	2417+66.491	2419+57.000	0.0361	0.013	0.3496	0.53
150	2419+57.000	2426+42.114	0.1298	0.128	0.9854	1.50
151	2426+42.114	2459+72.548	0.6308	0.169	0.2683	0.41
152	2459+72.548	2466+78.556	0.1337	0.046	0.3443	0.52
153	2466+78.556	2487+37.299	0.3899	0.105	0.2683	0.41

Table 6. Expected Crash Frequencies and Rates by Horizontal Design Element (Section 1)

Title	Start Location	End Location	Length (mi)	Expected No. Crashes for Evaluation Period	Crash Rate (crashes/mi/yr)	Travel Crash Rate (crashes/million veh-mi)
Tangent	1327+09.000	1336+44.302	0.1771	0.048	0.2683	0.41

Title	Start Location	End Location	Length (mi)	Expected No. Crashes for Evaluation Period	Crash Rate (crashes/mi/yr)	Travel Crash Rate (crashes/million veh-mi)
Simple Curve 1	1336+44.302	1345+88.891	0.1789	0.059	0.3301	0.50
Tangent	1345+88.891	1350+43.605	0.0861	0.024	0.2822	0.43
Simple Curve 2	1350+43.605	1355+75.006	0.1006	0.037	0.3716	0.57
Tangent	1355+75.006	1359+98.149	0.0801	0.021	0.2683	0.41
Simple Curve 3	1359+98.149	1375+23.561	0.2889	0.092	0.3183	0.48
Tangent	1375+23.561	1409+56.099	0.6501	0.186	0.2861	0.43
Simple Curve 4	1409+56.099	1420+94.274	0.2156	0.075	0.3503	0.53
Tangent	1420+94.274	1429+54.331	0.1629	0.045	0.2768	0.42
Simple Curve 5	1429+54.331	1439+38.259	0.1863	0.064	0.3433	0.52
Tangent	1439+38.259	1457+87.869	0.3503	0.088	0.2525	0.38
Simple Curve 6	1457+87.869	1463+32.941	0.1032	0.036	0.3540	0.54
Tangent	1463+32.941	1468+59.089	0.0996	0.029	0.2861	0.43
Simple Curve 7	1468+59.089	1477+61.956	0.1710	0.059	0.3472	0.53
Tangent	1477+61.956	1490+31.091	0.2404	0.128	0.5318	0.81
Simple Curve 8	1490+31.091	1506+85.128	0.3133	0.107	0.3405	0.52
Tangent	1506+85.128	1511+36.056	0.0854	0.024	0.2861	0.43
Simple Curve 9	1511+36.056	1518+02.293	0.1262	0.142	1.1234	1.71
Tangent	1518+02.293	1530+56.765	0.2376	0.133	0.5590	0.85
Simple Curve 10	1530+56.765	1546+35.066	0.2989	0.099	0.3319	0.51
Tangent	1546+35.066	1561+65.077	0.2898	0.071	0.2467	0.38
Simple Curve 11	1561+65.077	1575+49.666	0.2622	0.078	0.2980	0.45
Tangent	1575+49.666	1579+81.473	0.0818	0.020	0.2435	0.37
Simple Curve 12	1579+81.473	1587+62.614	0.1479	0.134	0.9043	1.38
Tangent	1587+62.614	1591+85.378	0.0801	0.019	0.2378	0.36
Simple Curve 13	1591+85.378	1604+98.065	0.2486	0.080	0.3206	0.49
Tangent	1604+98.065	1609+35.192	0.0828	0.020	0.2435	0.37
Simple Curve 14	1609+35.192	1614+65.403	0.1004	0.042	0.4155	0.63
Tangent	1614+65.403	1623+55.342	0.1685	0.046	0.2715	0.41
Simple Curve 15	1623+55.342	1634+67.324	0.2106	0.146	0.6932	1.05
Tangent	1634+67.324	1643+43.433	0.1659	0.115	0.6931	1.05
Simple Curve 16	1643+43.433	1662+05.617	0.3527	0.195	0.5530	0.84
Tangent	1662+05.617	1674+56.874	0.2370	0.127	0.5356	0.81
Simple Curve 17	1674+56.874	1684+84.121	0.1946	0.209	1.0758	1.64
Tangent	1684+84.121	1689+55.548	0.0893	0.019	0.2186	0.33
Simple Curve 18	1689+55.548	1697+38.184	0.1482	0.238	1.6032	2.44
Tangent	1697+38.184	1703+52.875	0.1164	0.077	0.6616	1.01
Simple Curve 19	1703+52.875	1713+92.335	0.1969	0.113	0.5748	0.88
Tangent	1713+92.335	1731+17.025	0.3266	0.073	0.2241	0.34
Simple Curve 20	1731+17.025	1736+82.212	0.1070	0.033	0.3084	0.47
Tangent	1736+82.212	1749+79.705	0.2457	0.136	0.5522	0.84
Simple Curve 21	1749+79.705	1756+47.361	0.1265	0.043	0.3436	0.52
Tangent	1756+47.361	1761+94.171	0.1036	0.024	0.2344	0.36
Simple Curve 22	1761+94.171	1769+37.986	0.1409	0.038	0.2690	0.41
Tangent	1769+37.986	1796+26.415	0.5092	0.116	0.2284	0.35
Simple Curve 23	1796+26.415	1801+11.457	0.0919	0.024	0.2576	0.39
Tangent	1801+11.457	1814+09.517	0.2458	0.112	0.4563	0.69
Simple Curve 24	1814+09.517	1819+97.464	0.1114	0.036	0.3262	0.50
Tangent	1819+97.464	1824+53.898	0.0864	0.019	0.2203	0.34
Simple Curve 25	1824+53.898	1830+41.880	0.1114	0.032	0.2850	0.43
Tangent	1830+41.880	1836+58.064	0.1167	0.083	0.7083	1.08
Simple Curve 26	1836+58.064	1844+74.496	0.1546	0.050	0.3213	0.49

Title	Start Location	End Location	Length (mi)	Expected No. Crashes for Evaluation Period	Crash Rate (crashes/mi/yr)	Travel Crash Rate (crashes/million veh-mi)
Tangent	1844+74.496	1849+15.104	0.0834	0.020	0.2344	0.36
Simple Curve 27	1849+15.104	1858+04.945	0.1685	0.056	0.3340	0.51
Tangent	1858+04.945	1869+49.895	0.2168	0.051	0.2344	0.36
Simple Curve 28	1869+49.895	1875+20.742	0.1081	0.108	0.9978	1.52
Tangent	1875+20.742	1902+52.815	0.5174	0.180	0.3480	0.53
Simple Curve 29	1902+52.815	1908+15.543	0.1066	0.127	1.1932	1.82
Tangent	1908+15.543	1912+56.122	0.0834	0.091	1.0954	1.67
Simple Curve 30	1912+56.122	1923+07.672	0.1992	0.070	0.3504	0.53
Tangent	1923+07.672	2070+98.406	2.8013	1.030	0.3678	0.56
Simple Curve 31	2070+98.406	2086+40.102	0.2920	0.087	0.2995	0.46
Tangent	2086+40.102	2140+56.643	1.0259	0.402	0.3918	0.60
Simple Curve 32	2140+56.643	2183+26.113	0.8086	0.239	0.2957	0.45
Tangent	2183+26.113	2201+13.109	0.3384	0.281	0.8297	1.26
Simple Curve 33	2201+13.109	2210+46.999	0.1769	0.057	0.3217	0.49
Tangent	2210+46.999	2252+38.958	0.7939	0.340	0.4279	0.65
Simple Curve 34	2252+38.958	2267+68.359	0.2897	0.091	0.3147	0.48
Tangent	2267+68.359	2275+17.825	0.1419	0.039	0.2778	0.42
Simple Curve 35	2275+17.825	2297+86.147	0.4296	0.137	0.3181	0.48
Tangent	2297+86.147	2324+46.955	0.5039	0.262	0.5197	0.79
Simple Curve 36	2324+46.955	2335+97.505	0.2179	0.220	1.0074	1.53
Tangent	2335+97.505	2388+01.647	0.9856	0.391	0.3969	0.60
Simple Curve 37	2388+01.647	2393+97.841	0.1129	0.122	1.0833	1.65
Tangent	2393+97.841	2399+08.519	0.0967	0.026	0.2683	0.41
Simple Curve 38	2399+08.519	2410+56.262	0.2174	0.075	0.3472	0.53
Tangent	2410+56.262	2415+67.769	0.0969	0.026	0.2683	0.41
Simple Curve 39	2415+67.769	2426+42.114	0.2035	0.236	1.1605	1.77
Tangent	2426+42.114	2459+72.548	0.6308	0.169	0.2683	0.41
Simple Curve 40	2459+72.548	2466+78.556	0.1337	0.046	0.3443	0.52
Tangent	2466+78.556	2487+37.299	0.3899	0.105	0.2683	0.41



**Table 7. Expected Segment Crash Type Distribution (Section 1)**

Element Type	Crash Type	FI Crashes	Percent FI (%)	PDO Crashes	Percent PDO (%)	Total Crashes	Percent Total (%)
Highway Segment	Collision with Animal	0.12	1.3	1.10	12.0	1.11	12.1
Highway Segment	Collision with Bicycle	0.01	0.1	0.01	0.1	0.02	0.2
Highway Segment	Other Single-vehicle Collision	0.02	0.2	0.17	1.9	0.19	2.1
Highway Segment	Overtaken	0.12	1.3	0.09	1.0	0.23	2.5
Highway Segment	Collision with Pedestrian	0.02	0.2	0.01	0.1	0.03	0.3
Highway Segment	Run Off Road	1.72	18.8	3.02	33.0	4.77	52.1
Highway Segment	Total Single Vehicle Crashes	2.02	22.1	4.40	48.1	6.34	69.3
Highway Segment	Angle Collision	0.32	3.5	0.43	4.7	0.78	8.5
Highway Segment	Head-on Collision	0.11	1.2	0.02	0.2	0.15	1.6
Highway Segment	Other Multiple-vehicle Collision	0.08	0.9	0.18	2.0	0.25	2.7
Highway Segment	Rear-end Collision	0.52	5.7	0.73	8.0	1.30	14.2
Highway Segment	Sideswipe	0.12	1.3	0.23	2.5	0.34	3.7
Highway Segment	Total Multiple Vehicle Crashes	1.15	12.6	1.59	17.3	2.81	30.7
Highway Segment	Total Highway Segment Crashes	3.17	34.6	5.99	65.4	9.15	100.0
	Total Crashes	3.17	34.6	5.99	65.4	9.15	100.0

**Note:** *Fatal and Injury Crashes* and *Property Damage Only Crashes* do not necessarily sum up to *Total Crashes* because the distribution of these three crashes had been derived independently.

*Interactive Highway Safety Design Model*

**Crash Prediction Evaluation Report**

**P1 Alignment Alternative**

April 3, 2018



## **Disclaimer**

The Interactive Highway Design Model (IHSDM) software is disseminated under the sponsorship of the Department of Transportation in the interest of information exchange. The United States Government assumes no liability for its content or use thereof. This document does not constitute a standard, specification, or regulation.

The United States Government does not endorse products or manufacturers. Trade and manufacturers' names may appear in this software and documentation only because they are considered essential to the objective of the software.

## **Limited Warranty and Limitations of Remedies**

This software product is provided "as-is," without warranty of any kind-either expressed or implied (but not limited to the implied warranties of merchantability and fitness for a particular purpose). The FHWA do not warrant that the functions contained in the software will meet the end-user's requirements or that the operation of the software will be uninterrupted and error-free.

Under no circumstances will the FHWA be liable to the end-user for any damages or claimed lost profits, lost savings, or other incidental or consequential damages rising out of the use or inability to use the software (even if these organizations have been advised of the possibility of such damages), or for any claim by any other party.

## **Notice**

The use of the IHSDM software is being done strictly on a voluntary basis. In exchange for provision of IHSDM, the user agrees that the Federal Highway Administration (FHWA), U.S. Department of Transportation and any other agency of the Federal Government shall not be responsible for any errors, damage or other liability that may result from any and all use of the software, including installation and testing of the software. The user further agrees to hold the FHWA and the Federal Government harmless from any resulting liability. The user agrees that this hold harmless provision shall flow to any person to whom or any entity to which the user provides the IHSDM software. It is the user's full responsibility to inform any person to whom or any entity to which it provides the IHSDM software of this hold harmless provision.

---

---

## Table of Contents

**Report Overview** ..... **1**  
**Section 1 Evaluation** ..... **2**

## List of Tables

Table Observed Crashes Used in the Evaluation (Section 1) ..... 3  
Table Evaluation Highway - Homogeneous Segments (Section 1) ..... 4  
Table Crash History Highway - Homogeneous Segments (Section 1) ..... 8  
Table Expected Highway Crash Rates and Frequencies (Section 1) ..... 12  
Table Expected Crash Frequencies and Rates by Highway Segment (Section 1) ..... 12  
Table Expected Crash Frequencies and Rates by Horizontal Design Element (Section 1) ..... 15  
Table Expected Segment Crash Type Distribution (Section 1) ..... 17

## List of Figures

Figure Crash Prediction Summary (Section 1) ..... 2

## Report Overview

**Report Generated:** Apr 3, 2018 4:02 PM

**Report Template:** System: Multi-Page, 508 Compliant [System] (mlcpm4, Oct 9, 2017 1:45 PM)

**Evaluation Date:** Tue Apr 03 14:03:37 AKDT 2018

**IHSDM Version:** v13.0.0 (Sep 13, 2017)

**Crash Prediction Module:** v8.0.0 (Sep 13, 2017)

**User Name:** RaeAnne Hebnes

**Organization Name:** Michael Baker International

**Phone:**

**E-Mail:**

**Project Title:** P1

**Project Comment:** Created using wizard

**Project Unit System:** U.S. Customary

**Highway Title:** Alignment P1\_6apr2018

**Highway Comment:** Copied from Alignment P1\_29dec2017 (v3); revised passing lanes

**Highway Version:** 1

**Evaluation Title:** Evaluation 4

**Evaluation Comment:** Created Tue Apr 03 14:01:10 AKDT 2018

**Minimum Station:** 1327+09.000

**Maximum Station:** 2468+96.256

**Policy for Superelevation:** AASHTO 2011 U.S. Customary

**Calibration:** HSM Configuration

**Crash Distribution:** HSM Configuration

**Model/CMF:** HSM Configuration

**Empirical-Bayes Analysis:** Site-Specific

**Highway with Crash History:** Alignment ParksHwy304-326 Asbuilt - 60 mph

**Highway with Crash History Comment:** Created By Civil Geometry

**Highway with Crash History Version:** 1

**First Year of Analysis:** 2017

**Last Year of Analysis:** 2017

# Section 1 Evaluation

**Section:** Section 1  
**Evaluation Start Location:** 1327+09.000  
**Evaluation End Location:** 2468+96.256  
**Area Type:** Rural  
**Functional Class:** Arterial  
**Type of Alignment:** Undivided, Two Lane  
**Model Category:** Rural, Two Lane  
**Calibration Factor:** 2U=1.0;

Crash Prediction Summary, Section 1 (Undivided, Two Lane; Rural; Arterial)  
 Project: P1, Evaluation: Evaluation 4  
 Highway: Alignment P1\_6apr2018

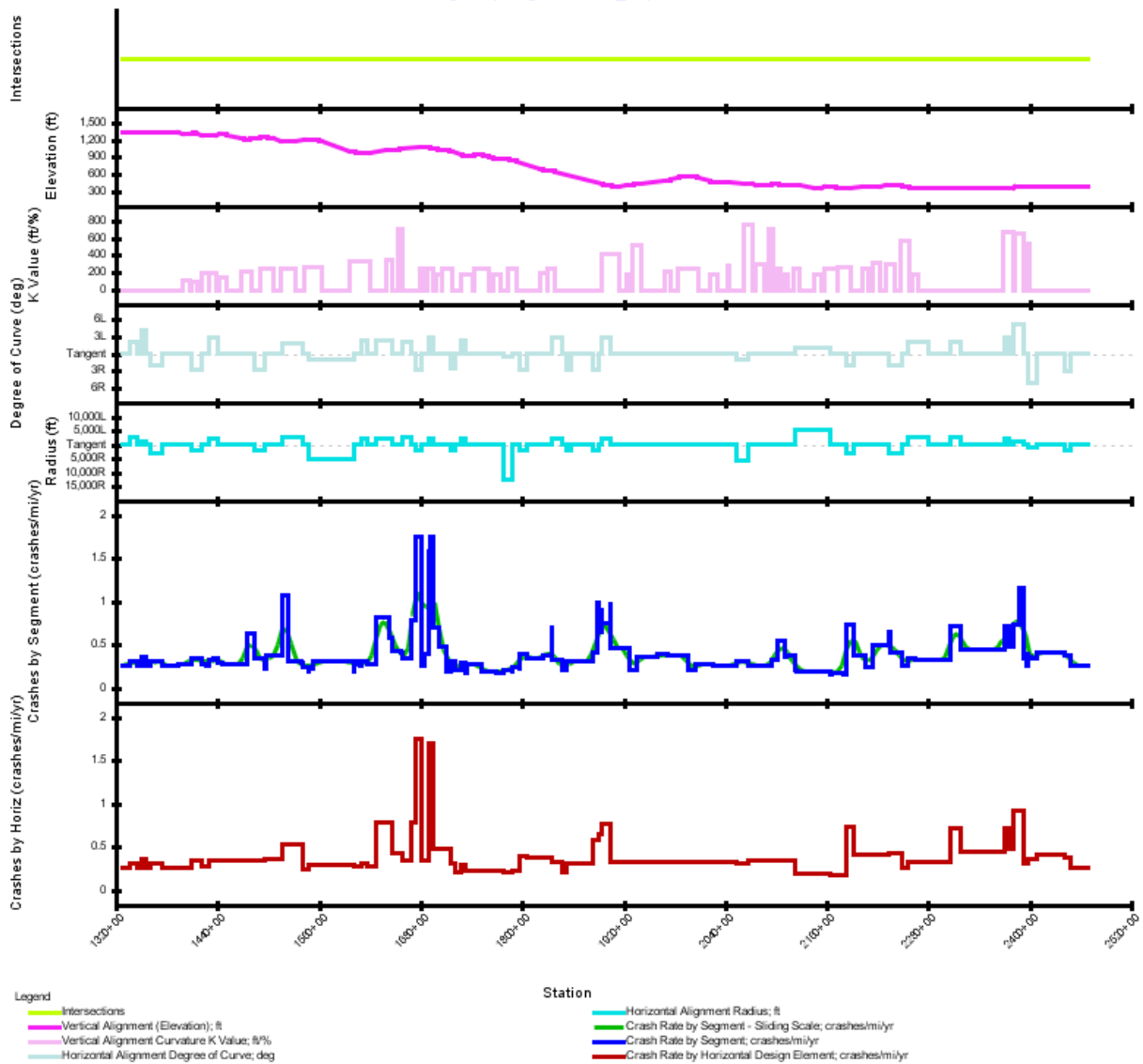

**Figure 1. Crash Prediction Summary (Section 1)**

**Table 1. Observed Crashes Used in the Evaluation (Section 1)**

Year	Observed Crashes	Total Crashes Used	FI Crashes	FI no/C Crashes	PDO Crashes
2010	9	7	3	1	4
2011	6	6	2	0	4
2012	7	7	2	0	5
2013	6	6	3	0	3
2014	17	16	7	0	9
All Years	45 &nbsp; <sup>[1]</sup>	42	17	1	25

**Footnotes**

<sup>[1]</sup> Note: Observed crash data that does not comply with the associated CPM model requirements may not be used in EB processing.



**Table 2. Evaluation Highway - Homogeneous Segments (Section 1)**

Seg. No.	Type	Start Location	End Location	Length (ft)	Length(mi)	AADT	Left Lane Width (ft)	Right Lane Width (ft)	Left Shoulder Width (ft)	Right Shoulder Width (ft)	Grade (%)	Driveway Density (driveways/mi)	Hazard Rating	Centerline Rumble Strip	Passing Lanes	TWLT Lane	Lighting	Automated Speed Enforcement	Radius (ft)	Superelevation (%)	Adverse	Design Speed (mph)
1	2U	1327+09.000	1336+44.302	935.30	0.1771	2017: 1,800	12.00	12.00	8.00	8.00	0.00	0.3	1	false	0	false	false	false				
2	2U	1336+44.302	1345+88.891	944.59	0.1789	2017: 1,800	12.00	12.00	8.00	8.00	0.00	0.3	1	false	0	false	false	false	2,864.79	2.0	true	70
3	2U	1345+88.891	1350+43.605	454.71	0.0861	2017: 1,800	12.00	12.00	8.00	8.00	0.00	0.3	1	false	0	false	false	false				
4	2U	1350+43.605	1355+75.006	531.40	0.1006	2017: 1,800	12.00	12.00	8.00	8.00	0.00	0.3	1	false	0	false	false	false	1,432.40	2.0	true	70
5	2U	1355+75.006	1359+98.149	423.14	0.0801	2017: 1,800	12.00	12.00	8.00	8.00	0.00	0.3	1	false	0	false	false	false				
6	2U	1359+98.149	1375+23.561	1,525.41	0.2889	2017: 1,800	12.00	12.00	8.00	8.00	0.00	0.3	1	false	0	false	false	false	2,864.79	2.0	true	70
7	2U	1375+23.561	1392+99.995	1,776.43	0.3365	2017: 1,800	12.00	12.00	8.00	8.00	0.00	0.3	1	false	0	false	false	false				
8	2U	1392+99.995	1402+71.610	971.62	0.1840	2017: 1,800	12.00	12.00	8.00	8.00	3.20	0.3	1	false	0	false	false	false				
9	2U	1402+71.610	1409+13.059	641.45	0.1215	2017: 1,800	12.00	12.00	8.00	8.00	4.00	0.3	1	false	0	false	false	false				
10	2U	1409+13.059	1412+82.259	369.20	0.0699	2017: 1,800	12.00	12.00	8.00	8.00	4.00	0.3	1	false	0	false	false	false	2,050.00	2.0	true	70
11	2U	1412+82.259	1421+34.750	852.49	0.1615	2017: 1,800	12.00	12.00	8.00	8.00	4.15	0.3	1	false	0	false	false	false	2,050.00	2.0	true	70
12	2U	1421+34.750	1425+63.830	429.08	0.0813	2017: 1,800	12.00	12.00	8.00	8.00	4.15	0.3	1	false	0	false	false	false				
13	2U	1425+63.830	1429+14.849	351.02	0.0665	2017: 1,800	12.00	12.00	8.00	8.00	0.50	0.3	1	false	0	false	false	false				
14	2U	1429+14.849	1434+46.905	532.06	0.1008	2017: 1,800	12.00	12.00	8.00	8.00	0.50	0.3	1	false	0	false	false	false	2,050.00	2.0	true	70
15	2U	1434+46.905	1439+70.975	524.07	0.0993	2017: 1,800	12.00	12.00	8.00	8.00	3.20	0.3	1	false	0	false	false	false	2,050.00	2.0	true	70
16	2U	1439+70.975	1446+39.840	668.87	0.1267	2017: 1,800	12.00	12.00	8.00	8.00	3.20	0.3	1	false	0	false	false	false				
17	2U	1446+39.840	1474+21.199	2,781.36	0.5268	2017: 1,800	12.00	12.00	8.00	8.00	3.75	0.3	1	false	0	false	false	false				
18	2U	1474+21.199	1482+80.502	859.30	0.1628	2017: 1,800	12.00	12.00	8.00	8.00	2.19	0.3	1	false	0	false	false	false				
19	2U	1482+80.502	1495+04.091	1,223.59	0.2317	2017: 1,800	12.00	12.00	8.00	8.00	2.19	0.3	1	false	0	false	false	false	2,100.00	2.0	true	70
20	2U	1495+04.091	1497+85.714	281.62	0.0533	2017: 1,800	12.00	12.00	8.00	8.00	2.19	0.3	1	false	0	false	false	false				
21	2U	1497+85.714	1516+97.763	1,912.05	0.3621	2017: 1,800	12.00	12.00	8.00	8.00	4.00	0.3	1	false	0	false	false	false				
22	2U	1516+97.763	1524+02.290	704.53	0.1334	2017: 1,800	12.00	12.00	8.00	8.00	4.00	0.3	1	false	0	false	false	false	3,000.00	2.0	true	70
23	2U	1524+02.290	1538+60.000	1,457.71	0.2761	2017: 1,800	12.00	12.00	8.00	8.00	2.81	0.3	1	false	0	false	false	false	3,000.00	2.0	true	70
24	2U	1538+60.000	1540+55.785	195.78	0.0371	2017: 1,800	12.00	12.00	8.00	8.00	2.81	0.3	1	false	0	false	false	false	3,000.00	2.0	true	70
25	2U	1540+55.785	1547+00.000	644.22	0.1220	2017: 1,800	12.00	12.00	8.00	8.00	2.81	0.3	1	false	0	false	false	false				
26	2U	1547+00.000	1547+28.434	28.43	0.0054	2017: 1,800	12.00	12.00	8.00	8.00	2.81	0.3	1	false	1	false	false	false				
27	2U	1547+28.434	1552+44.906	516.47	0.0978	2017: 1,800	12.00	12.00	8.00	8.00	2.81	0.3	1	false	1	false	false	false	5,000.00	2.0	true	70
28	2U	1552+44.906	1601+34.699	4,889.79	0.9261	2017: 1,800	12.00	12.00	8.00	8.00	5.00	0.3	1	false	1	false	false	false	5,000.00	2.0	true	70
29	2U	1601+34.699	1602+00.000	65.30	0.0124	2017: 1,800	12.00	12.00	8.00	8.00	5.00	0.3	1	false	1	false	false	false				
30	2U	1602+00.000	1607+40.000	540.00	0.1023	2017: 1,800	12.00	12.00	8.00	8.00	5.00	0.3	1	false	0	false	false	false				
31	2U	1607+40.000	1608+61.172	121.17	0.0230	2017: 1,800	12.00	12.00	8.00	8.00	5.00	0.3	1	false	0	false	false	false				
32	2U	1608+61.172	1609+61.022	99.85	0.0189	2017: 1,800	12.00	12.00	8.00	8.00	2.28	0.3	1	false	0	false	false	false				
33	2U	1609+61.022	1616+84.156	723.13	0.1370	2017: 1,800	12.00	12.00	8.00	8.00	2.28	0.3	1	false	0	false	false	false	2,500.00	2.0	true	70
34	2U	1616+84.156	1627+49.440	1,065.28	0.2018	2017: 1,800	12.00	12.00	8.00	8.00	2.28	0.3	1	false	0	false	false	false				
35	2U	1627+49.440	1643+09.371	1,559.93	0.2954	2017: 1,800	12.00	12.00	8.00	8.00	2.28	0.3	1	false	0	false	false	false	2,550.00	2.0	true	70
36	2U	1643+09.371	1646+14.198	304.83	0.0577	2017: 1,800	12.00	12.00	8.00	8.00	0.60	0.3	1	false	0	false	false	false	2,550.00	2.0	true	70
37	2U	1646+14.198	1656+49.808	1,035.61	0.1961	2017: 1,800	12.00	12.00	8.00	8.00	0.60	0.3	1	false	0	false	false	false				
38	2U	1656+49.808	1658+64.069	214.26	0.0406	2017: 1,800	12.00	12.00	8.00	8.00	1.30	0.3	1	false	0	false	false	false				
39	2U	1658+64.069	1668+91.391	1,027.32	0.1946	2017: 1,800	12.00	12.00	8.00	8.00	1.30	0.3	1	false	0	false	false	false	2,865.00	2.0	true	70
40	2U	1668+91.391	1674+04.477	513.09	0.0972	2017: 1,800	12.00	12.00	8.00	8.00	1.30	0.3	1	false	0	false	false	false				

Seg. No.	Type	Start Location	End Location	Length (ft)	Length(mi)	AADT	Left Lane Width (ft)	Right Lane Width (ft)	Left Shoulder Width (ft)	Right Shoulder Width (ft)	Grade (%)	Driveway Density (driveways/mi)	Hazard Rating	Centerline Rumble Strip	Passing Lanes	TWL Lane	Lighting	Automated Speed Enforcement	Radius (ft)	Superelevation (%)	Adverse	Design Speed (mph)
41	2U	1674+04.477	1681+04.530	700.05	0.1326	2017: 1,800	12.00	12.00	8.00	8.00	1.30	0.3	1	false	0	false	false	false	2,050.00	2.0	true	70
42	2U	1681+04.530	1681+60.000	55.47	0.0105	2017: 1,800	12.00	12.00	8.00	8.00	1.30	0.3	1	false	0	false	false	false				
43	2U	1681+60.000	1681+76.437	16.44	0.0031	2017: 1,800	12.00	12.00	8.00	8.00	1.30	0.3	1	false	0	false	false	false				
44	2U	1681+76.437	1684+40.000	263.56	0.0499	2017: 1,800	12.00	12.00	8.00	8.00	0.70	0.3	1	false	0	false	false	false				
45	2U	1684+40.000	1690+03.213	563.21	0.1067	2017: 1,800	12.00	12.00	8.00	8.00	0.70	0.3	1	false	0	false	false	false				
46	2U	1690+03.213	1691+78.561	175.35	0.0332	2017: 1,800	12.00	12.00	8.00	8.00	0.70	0.3	1	false	2	false	false	false	2,050.00	2.0	true	70
47	2U	1691+78.561	1695+61.079	382.52	0.0725	2017: 1,800	12.00	12.00	8.00	8.00	3.25	0.3	1	false	2	false	false	false	2,050.00	2.0	true	70
48	2U	1695+61.079	1701+91.852	630.77	0.1195	2017: 1,800	12.00	12.00	8.00	8.00	3.25	0.3	1	false	2	false	false	false				
49	2U	1701+91.852	1711+10.262	918.41	0.1739	2017: 1,800	12.00	12.00	8.00	8.00	0.25	0.3	1	false	2	false	false	false				
50	2U	1711+10.262	1715+28.063	417.80	0.0791	2017: 1,800	12.00	12.00	8.00	8.00	5.00	0.3	1	false	2	false	false	false				
51	2U	1715+28.063	1720+93.250	565.19	0.1070	2017: 1,800	12.00	12.00	8.00	8.00	5.00	0.3	1	false	2	false	false	false	2,150.00	2.0	true	70
52	2U	1720+93.250	1727+11.379	618.13	0.1171	2017: 1,800	12.00	12.00	8.00	8.00	5.00	0.3	1	false	2	false	false	false				
53	2U	1727+11.379	1732+47.637	536.26	0.1016	2017: 1,800	12.00	12.00	8.00	8.00	5.00	0.3	1	false	2	false	false	false	2,500.00	2.0	true	70
54	2U	1732+47.637	1734+23.268	175.63	0.0333	2017: 1,800	12.00	12.00	8.00	8.00	5.00	0.3	1	false	2	false	false	false				
55	2U	1734+23.268	1751+94.855	1,771.59	0.3355	2017: 1,800	12.00	12.00	8.00	8.00	2.30	0.3	1	false	2	false	false	false				
56	2U	1751+94.855	1769+82.986	1,788.13	0.3387	2017: 1,800	12.00	12.00	8.00	8.00	5.00	0.3	1	false	2	false	false	false				
57	2U	1769+82.986	1777+26.252	743.27	0.1408	2017: 1,800	12.00	12.00	8.00	8.00	0.30	0.3	1	false	2	false	false	false				
58	2U	1777+26.252	1787+88.934	1,062.68	0.2013	2017: 1,800	12.00	12.00	8.00	8.00	0.30	0.3	1	false	2	false	false	false	12,500.00	2.0	true	70
59	2U	1787+88.934	1788+00.000	11.07	0.0021	2017: 1,800	12.00	12.00	8.00	8.00	0.30	0.3	1	false	2	false	false	false				
60	2U	1788+00.000	1788+28.379	28.38	0.0054	2017: 1,800	12.00	12.00	8.00	8.00	0.30	0.3	1	false	1	false	false	false				
61	2U	1788+28.379	1796+40.000	811.62	0.1537	2017: 1,800	12.00	12.00	8.00	8.00	5.00	0.3	1	false	1	false	false	false				
62	2U	1796+40.000	1796+64.739	24.74	0.0047	2017: 1,800	12.00	12.00	8.00	8.00	5.00	0.3	1	false	1	false	false	false				
63	2U	1796+64.739	1805+16.197	851.46	0.1613	2017: 1,800	12.00	12.00	8.00	8.00	5.00	0.3	1	false	1	false	false	false	2,100.00	2.0	true	70
64	2U	1805+16.197	1824+87.158	1,970.96	0.3733	2017: 1,800	12.00	12.00	8.00	8.00	5.00	0.3	1	false	1	false	false	false				
65	2U	1824+87.158	1834+41.613	954.46	0.1808	2017: 1,800	12.00	12.00	8.00	8.00	0.50	0.3	1	false	1	false	false	false				
66	2U	1834+41.613	1836+00.912	159.30	0.0302	2017: 1,800	12.00	12.00	8.00	8.00	4.00	0.3	1	false	1	false	false	false				
67	2U	1836+00.912	1846+67.512	1,066.60	0.2020	2017: 1,800	12.00	12.00	8.00	8.00	4.00	0.3	1	false	1	false	false	false	2,100.00	2.0	true	70
68	2U	1846+67.512	1852+40.031	572.52	0.1084	2017: 1,800	12.00	12.00	8.00	8.00	4.00	0.3	1	false	1	false	false	false				
69	2U	1852+40.031	1857+23.946	483.92	0.0916	2017: 1,800	12.00	12.00	8.00	8.00	4.00	0.3	1	false	1	false	false	false	2,050.00	2.0	true	70
70	2U	1857+23.946	1884+07.604	2,683.66	0.5083	2017: 1,800	12.00	12.00	8.00	8.00	4.00	0.3	1	false	1	false	false	false				
71	2U	1884+07.604	1888+18.580	410.98	0.0778	2017: 1,800	12.00	12.00	8.00	8.00	4.00	0.3	1	false	1	false	false	false	2,050.00	2.0	true	70
72	2U	1888+18.580	1889+90.226	171.65	0.0325	2017: 1,800	12.00	12.00	8.00	8.00	4.00	0.3	1	false	0	false	false	false	2,050.00	2.0	true	70
73	2U	1889+90.226	1893+58.268	368.04	0.0697	2017: 1,800	12.00	12.00	8.00	8.00	4.00	0.3	1	false	0	false	false	false				
74	2U	1893+58.268	1893+78.840	20.57	0.0039	2017: 1,800	12.00	12.00	8.00	8.00	4.00	0.3	1	false	0	false	false	false	2,050.00	2.0	true	70
75	2U	1893+78.840	1904+31.592	1,052.75	0.1994	2017: 1,800	12.00	12.00	8.00	8.00	4.00	0.3	1	false	0	false	false	false	2,050.00	2.0	true	70
76	2U	1904+31.592	1904+85.312	53.72	0.0102	2017: 1,800	12.00	12.00	8.00	8.00	0.60	0.3	1	false	0	false	false	false	2,050.00	2.0	true	70
77	2U	1904+85.312	1926+66.640	2,181.33	0.4131	2017: 1,800	12.00	12.00	8.00	8.00	0.60	0.3	1	false	0	false	false	false				
78	2U	1926+66.640	1927+22.000	55.36	0.0105	2017: 1,800	12.00	12.00	8.00	8.00	3.35	0.3	1	false	0	false	false	false				
79	2U	1927+22.000	1935+48.888	826.89	0.1566	2017: 1,800	12.00	12.00	8.00	8.00	3.35	0.3	1	false	1	false	false	false				
80	2U	1935+48.888	1960+00.000	2,451.11	0.4642	2017: 1,800	12.00	12.00	8.00	8.00	1.30	0.3	1	false	1	false	false	false				
81	2U	1960+00.000	1971+83.570	1,183.57	0.2242	2017: 1,800	12.00	12.00	8.00	8.00	1.30	0.3	1	false	1	false	false	false				
82	2U	1971+83.570	1996+07.182	2,423.61	0.4590	2017: 1,800	12.00	12.00	8.00	8.00	5.00	0.3	1	false	1	false	false	false				
83	2U	1996+07.182	2005+00.000	892.82	0.1691	2017: 1,800	12.00	12.00	8.00	8.00	5.00	0.3	1	false	1	false	false	false				

Seg. No.	Type	Start Location	End Location	Length (ft)	Length(mi)	AADT	Left Lane Width (ft)	Right Lane Width (ft)	Left Shoulder Width (ft)	Right Shoulder Width (ft)	Grade (%)	Driveway Density (driveways/mi)	Hazard Rating	Centerline Rumble Strip	Passing Lanes	TWLT Lane	Lighting	Automated Speed Enforcement	Radius (ft)	Superelevation (%)	Adverse	Design Speed (mph)
84	2U	2005+00.000	2013+40.000	840.00	0.1591	2017: 1,800	12.00	12.00	8.00	8.00	5.00	0.3	1	false	0	false	false	false				
85	2U	2013+40.000	2026+04.926	1,264.93	0.2396	2017: 1,800	12.00	12.00	8.00	8.00	5.00	0.3	1	false	0	false	false	false				
86	2U	2026+04.926	2043+53.697	1,748.77	0.3312	2017: 1,800	12.00	12.00	8.00	8.00	0.20	0.3	1	false	0	false	false	false				
87	2U	2043+53.697	2052+62.284	908.59	0.1721	2017: 1,800	12.00	12.00	8.00	8.00	0.80	0.3	1	false	0	false	false	false				
88	2U	2052+62.284	2066+79.057	1,416.77	0.2683	2017: 1,800	12.00	12.00	8.00	8.00	0.80	0.3	1	false	0	false	false	false	5,730.00	2.0	true	70
89	2U	2066+79.057	2067+99.438	120.38	0.0228	2017: 1,800	12.00	12.00	8.00	8.00	2.15	0.3	1	false	0	false	false	false	5,730.00	2.0	true	70
90	2U	2067+99.438	2080+84.795	1,285.36	0.2434	2017: 1,800	12.00	12.00	8.00	8.00	2.15	0.3	1	false	0	false	false	false				
91	2U	2080+84.795	2094+08.836	1,324.04	0.2508	2017: 1,800	12.00	12.00	8.00	8.00	1.30	0.3	1	false	0	false	false	false				
92	2U	2094+08.836	2101+60.000	751.16	0.1423	2017: 1,800	12.00	12.00	8.00	8.00	0.35	0.3	1	false	0	false	false	false				
93	2U	2101+60.000	2102+53.154	93.15	0.0176	2017: 1,800	12.00	12.00	8.00	8.00	0.35	0.3	1	false	0	false	false	false				
94	2U	2102+53.154	2104+40.000	186.85	0.0354	2017: 1,800	12.00	12.00	8.00	8.00	2.20	0.3	1	false	0	false	false	false				
95	2U	2104+40.000	2110+00.000	560.00	0.1061	2017: 1,800	12.00	12.00	8.00	8.00	2.20	0.3	1	false	0	false	false	false				
96	2U	2110+00.000	2111+68.168	168.17	0.0319	2017: 1,800	12.00	12.00	8.00	8.00	2.20	0.3	1	false	2	false	false	false				
97	2U	2111+68.168	2122+15.751	1,047.58	0.1984	2017: 1,800	12.00	12.00	8.00	8.00	0.40	0.3	1	false	2	false	false	false				
98	2U	2122+15.751	2124+49.703	233.95	0.0443	2017: 1,800	12.00	12.00	8.00	8.00	0.40	0.3	1	false	2	false	false	false	5,730.00	2.0	true	70
99	2U	2124+49.703	2149+30.199	2,480.50	0.4698	2017: 1,800	12.00	12.00	8.00	8.00	2.03	0.3	1	false	2	false	false	false	5,730.00	2.0	true	70
100	2U	2149+30.199	2164+85.534	1,555.34	0.2946	2017: 1,800	12.00	12.00	8.00	8.00	2.25	0.3	1	false	2	false	false	false	5,730.00	2.0	true	70
101	2U	2164+85.534	2165+23.218	37.68	0.0071	2017: 1,800	12.00	12.00	8.00	8.00	2.25	0.3	1	false	2	false	false	false				
102	2U	2165+23.218	2180+30.331	1,507.11	0.2854	2017: 1,800	12.00	12.00	8.00	8.00	3.65	0.3	1	false	2	false	false	false				
103	2U	2180+30.331	2182+72.331	242.00	0.0458	2017: 1,800	12.00	12.00	8.00	8.00	2.00	0.3	1	false	2	false	false	false				
104	2U	2182+72.331	2192+06.289	933.96	0.1769	2017: 1,800	12.00	12.00	8.00	8.00	2.00	0.3	1	false	2	false	false	false	2,865.00	2.0	true	70
105	2U	2192+06.289	2205+63.286	1,357.00	0.2570	2017: 1,800	12.00	12.00	8.00	8.00	2.00	0.3	1	false	2	false	false	false				
106	2U	2205+63.286	2215+00.000	936.71	0.1774	2017: 1,800	12.00	12.00	8.00	8.00	0.50	0.3	1	false	2	false	false	false				
107	2U	2215+00.000	2218+86.582	386.58	0.0732	2017: 1,800	12.00	12.00	8.00	8.00	0.50	0.3	1	false	0	false	false	false				
108	2U	2218+86.582	2220+60.000	173.42	0.0328	2017: 1,800	12.00	12.00	8.00	8.00	2.00	0.3	1	false	0	false	false	false				
109	2U	2220+60.000	2223+43.040	283.04	0.0536	2017: 1,800	12.00	12.00	8.00	8.00	2.00	0.3	1	false	0	false	false	false				
110	2U	2223+43.040	2233+97.851	1,054.81	0.1998	2017: 1,800	12.00	12.00	8.00	8.00	2.00	0.3	1	false	0	false	false	false				
111	2U	2233+97.851	2235+36.760	138.91	0.0263	2017: 1,800	12.00	12.00	8.00	8.00	2.00	0.3	1	false	0	false	false	false	2,790.00	2.0	true	70
112	2U	2235+36.760	2249+27.960	1,391.20	0.2635	2017: 1,800	12.00	12.00	8.00	8.00	1.55	0.3	1	false	0	false	false	false	2,790.00	2.0	true	70
113	2U	2249+27.960	2252+53.753	325.79	0.0617	2017: 1,800	12.00	12.00	8.00	8.00	1.55	0.3	1	false	0	false	false	false				
114	2U	2252+53.753	2256+76.507	422.75	0.0801	2017: 1,800	12.00	12.00	8.00	8.00	3.60	0.3	1	false	0	false	false	false				
115	2U	2256+76.507	2264+25.664	749.16	0.1419	2017: 1,800	12.00	12.00	8.00	8.00	3.60	0.3	1	false	0	false	false	false	2,790.00	2.0	true	70
116	2U	2264+25.664	2279+45.879	1,520.21	0.2879	2017: 1,800	12.00	12.00	8.00	8.00	0.10	0.3	1	false	0	false	false	false	2,790.00	2.0	true	70
117	2U	2279+45.879	2306+05.945	2,660.07	0.5038	2017: 1,800	12.00	12.00	8.00	8.00	0.10	0.3	1	false	0	false	false	false				
118	2U	2306+05.945	2317+56.861	1,150.92	0.2180	2017: 1,800	12.00	12.00	8.00	8.00	0.10	0.3	1	false	0	false	false	false	2,865.00	2.0	true	70
119	2U	2317+56.861	2369+38.765	5,181.90	0.9814	2017: 1,800	12.00	12.00	8.00	8.00	0.10	0.3	1	false	0	false	false	false				
120	2U	2369+38.765	2374+65.324	526.56	0.0997	2017: 1,800	12.00	12.00	8.00	8.00	0.10	0.3	1	false	0	false	false	false	2,050.00	2.0	true	55
121	2U	2374+65.324	2375+78.706	113.38	0.0215	2017: 1,800	12.00	12.00	8.00	8.00	1.75	0.3	1	false	0	false	false	false	2,050.00	2.0	true	55
122	2U	2375+78.706	2380+67.835	489.13	0.0926	2017: 1,800	12.00	12.00	8.00	8.00	1.75	0.3	1	false	0	false	false	false				
123	2U	2380+67.835	2386+97.264	629.43	0.1192	2017: 1,800	12.00	12.00	8.00	8.00	1.75	0.3	1	false	0	false	false	false	1,145.00	2.0	true	55
124	2U	2386+97.264	2392+14.656	517.39	0.0980	2017: 1,800	12.00	12.00	8.00	8.00	0.10	0.3	1	false	0	false	false	false	1,145.00	2.0	true	55
125	2U	2392+14.656	2395+38.442	323.79	0.0613	2017: 1,800	12.00	12.00	8.00	8.00	0.10	0.3	1	false	0	false	false	false				
126	2U	2395+38.442	2397+27.128	188.69	0.0357	2017: 1,800	12.00	12.00	8.00	8.00	1.00	0.3	1	false	0	false	false	false				

Seg. No.	Type	Start Location	End Location	Length (ft)	Length(mi)	AADT	Left Lane Width (ft)	Right Lane Width (ft)	Left Shoulder Width (ft)	Right Shoulder Width (ft)	Grade (%)	Driveway Density (driveways/mi)	Hazard Rating	Centerline Rumble Strip	Passing Lanes	TWLT Lane	Lighting	Automated Speed Enforcement	Radius (ft)	Superelevation (%)	Adverse	Design Speed (mph)
127	2U	2397+27.128	2398+49.027	121.90	0.0231	2017: 1,800	12.00	12.00	8.00	8.00	1.00	0.3	1	false	0	false	false	false	1,145.00	2.0	true	55
128	2U	2398+49.027	2400+99.997	250.97	0.0475	2017: 1,800	12.00	12.00	8.00	8.00	0.25	0.3	1	false	0	false	false	false	1,145.00	2.0	true	55
129	2U	2400+99.997	2408+00.619	700.62	0.1327	2017: 1,800	12.00	12.00	8.00	8.00	0.00	0.3	1	false	0	false	false	false	1,145.00	2.0	true	55
130	2U	2408+00.619	2441+31.129	3,330.51	0.6308	2017: 1,800	12.00	12.00	8.00	8.00	0.00	0.3	1	false	0	false	false	false				
131	2U	2441+31.129	2448+37.898	706.77	0.1339	2017: 1,800	12.00	12.00	8.00	8.00	0.00	0.3	1	false	0	false	false	false	1,915.00	2.0	true	55
132	2U	2448+37.898	2468+96.256	2,058.36	0.3898	2017: 1,800	12.00	12.00	8.00	8.00	0.00	0.3	1	false	0	false	false	false				

**Table 3. Crash History Highway - Homogeneous Segments (Section 1)**

Seg. No.	Type	Start Location	End Location	Length (ft)	Length (mi)	AADT	Left Lane Width (ft)	Right Lane Width (ft)	Left Shoulder Width (ft)	Right Shoulder Width (ft)	Grade (%)	Driveway Density (driveways/mi)	Hazard Rating	Centerline Rumble Strip	Passing Lanes	TWLT Lane	Lighting	Automated Speed Enforcement	Radius (ft)	Superelevation (%)	Adverse	Design Speed (mph)
1	2U	1327+09.000	1336+44.302	935.30	0.1771	2010-2014: 1,836	12.00	12.00	8.00	8.00	0.00	0.3	1	false	0	false	false	false				
2	2U	1336+44.302	1341+64.474	520.17	0.0985	2010-2014: 1,836	12.00	12.00	8.00	8.00	0.00	0.3	1	false	0	false	false	false	2,864.79	2.0	true	65
3	2U	1341+64.474	1345+88.891	424.42	0.0804	2010-2014: 1,836	12.00	12.00	8.00	8.00	6.00	0.3	1	false	0	false	false	false	2,864.79	2.0	true	65
4	2U	1345+88.891	1349+42.437	353.55	0.0670	2010-2014: 1,836	12.00	12.00	8.00	8.00	6.00	0.3	1	false	0	false	false	false				
5	2U	1349+42.437	1350+43.605	101.17	0.0192	2010-2014: 1,836	12.00	12.00	8.00	8.00	0.00	0.3	1	false	0	false	false	false				
6	2U	1350+43.605	1355+75.006	531.40	0.1006	2010-2014: 1,836	12.00	12.00	8.00	8.00	0.00	0.3	1	false	0	false	false	false	1,432.40	2.0	true	65
7	2U	1355+75.006	1359+98.149	423.14	0.0801	2010-2014: 1,836	12.00	12.00	8.00	8.00	0.00	0.3	1	false	0	false	false	false				
8	2U	1359+98.149	1361+84.449	186.30	0.0353	2010-2014: 1,836	12.00	12.00	8.00	8.00	0.00	0.3	1	false	0	false	false	false	2,864.79	2.0	true	65
9	2U	1361+84.449	1372+13.914	1,029.46	0.1950	2010-2014: 1,836	12.00	12.00	8.00	8.00	2.77	0.3	1	false	0	false	false	false	2,864.79	2.0	true	65
10	2U	1372+13.914	1375+23.561	309.65	0.0587	2010-2014: 1,836	12.00	12.00	8.00	8.00	3.10	0.3	1	false	0	false	false	false	2,864.79	2.0	true	65
11	2U	1375+23.561	1403+14.142	2,790.58	0.5285	2010-2014: 1,836	12.00	12.00	8.00	8.00	3.10	0.3	1	false	0	false	false	false				
12	2U	1403+14.142	1409+56.099	641.96	0.1216	2010-2014: 1,836	12.00	12.00	8.00	8.00	4.20	0.3	1	false	0	false	false	false				
13	2U	1409+56.099	1413+11.581	355.48	0.0673	2010-2014: 1,836	12.00	12.00	8.00	8.00	4.20	0.3	1	false	0	false	false	false	1,909.86	2.0	true	65
14	2U	1413+11.581	1420+94.274	782.69	0.1482	2010-2014: 1,836	12.00	12.00	8.00	8.00	4.57	0.3	1	false	0	false	false	false	1,909.86	2.0	true	65
15	2U	1420+94.274	1425+01.019	406.75	0.0770	2010-2014: 1,836	12.00	12.00	8.00	8.00	4.57	0.3	1	false	0	false	false	false				
16	2U	1425+01.019	1429+54.331	453.31	0.0858	2010-2014: 1,836	12.00	12.00	8.00	8.00	0.50	0.3	1	false	0	false	false	false				
17	2U	1429+54.331	1434+88.047	533.72	0.1011	2010-2014: 1,836	12.00	12.00	8.00	8.00	0.50	0.3	1	false	0	false	false	false	1,909.86	2.0	true	65
18	2U	1434+88.047	1439+38.259	450.21	0.0853	2010-2014: 1,836	12.00	12.00	8.00	8.00	3.40	0.3	1	false	0	false	false	false	1,909.86	2.0	true	65
19	2U	1439+38.259	1442+00.000	261.74	0.0496	2010-2014: 1,836	12.00	12.00	8.00	8.00	3.40	0.3	1	false	0	false	false	false				
20	2U	1442+00.000	1445+85.729	385.73	0.0731	2010-2014: 1,836	12.00	12.00	8.00	8.00	3.40	0.3	1	false	1	false	false	false				
21	2U	1445+85.729	1454+00.000	814.27	0.1542	2010-2014: 1,836	12.00	12.00	8.00	8.00	3.50	0.3	1	false	1	false	false	false				
22	2U	1454+00.000	1457+87.869	387.87	0.0735	2010-2014: 1,836	12.00	12.00	8.00	8.00	3.50	0.3	1	false	0	false	false	false				
23	2U	1457+87.869	1463+32.941	545.07	0.1032	2010-2014: 1,836	12.00	12.00	8.00	8.00	3.50	0.3	1	false	0	false	false	false	2,864.79	2.0	true	65
24	2U	1463+32.941	1468+59.089	526.15	0.0997	2010-2014: 1,836	12.00	12.00	8.00	8.00	3.50	0.3	1	false	0	false	false	false				
25	2U	1468+59.089	1473+71.093	512.00	0.0970	2010-2014: 1,836	12.00	12.00	8.00	8.00	3.50	0.3	1	false	0	false	false	false	1,950.00	2.0	true	65
26	2U	1473+71.093	1477+61.956	390.86	0.0740	2010-2014: 1,836	12.00	12.00	8.00	8.00	0.30	0.3	1	false	0	false	false	false	1,950.00	2.0	true	65
27	2U	1477+61.956	1482+39.570	477.61	0.0905	2010-2014: 1,836	12.00	12.00	8.00	8.00	0.30	0.3	1	false	0	false	false	false				
28	2U	1482+39.570	1490+31.091	791.52	0.1499	2010-2014: 1,836	12.00	12.00	8.00	8.00	0.60	0.3	1	false	0	false	false	false				
29	2U	1490+31.091	1502+99.266	1,268.17	0.2402	2010-2014: 1,836	12.00	12.00	8.00	8.00	0.60	0.3	1	false	0	false	false	false	1,155.00	2.0	true	65
30	2U	1502+99.266	1506+85.128	385.86	0.0731	2010-2014: 1,836	12.00	12.00	8.00	8.00	4.20	0.3	1	false	0	false	false	false	1,155.00	2.0	true	65
31	2U	1506+85.128	1511+36.056	450.93	0.0854	2010-2014: 1,836	12.00	12.00	8.00	8.00	4.20	0.3	1	false	0	false	false	false				
32	2U	1511+36.056	1518+02.293	666.24	0.1262	2010-2014: 1,836	12.00	12.00	8.00	8.00	4.20	0.3	1	false	0	false	false	false	1,145.92	2.0	true	65
33	2U	1518+02.293	1522+56.443	454.15	0.0860	2010-2014: 1,836	12.00	12.00	8.00	8.00	4.20	0.3	1	false	0	false	false	false				
34	2U	1522+56.443	1530+56.765	800.32	0.1516	2010-2014: 1,836	12.00	12.00	8.00	8.00	2.40	0.3	1	false	0	false	false	false				
35	2U	1530+56.765	1532+29.037	172.27	0.0326	2010-2014: 1,836	12.00	12.00	8.00	8.00	2.40	0.3	1	false	0	false	false	false	1,440.00	2.0	true	65
36	2U	1532+29.037	1546+35.066	1,406.03	0.2663	2010-2014: 1,836	12.00	12.00	8.00	8.00	1.55	0.3	1	false	0	false	false	false	1,440.00	2.0	true	65
37	2U	1546+35.066	1555+00.000	864.93	0.1638	2010-2014: 1,836	12.00	12.00	8.00	8.00	1.55	0.3	1	false	0	false	false	false				
38	2U	1555+00.000	1555+42.935	42.94	0.0081	2010-2014: 1,836	12.00	12.00	8.00	8.00	1.55	0.3	1	false	1	false	false	false				
39	2U	1555+42.935	1561+65.077	622.14	0.1178	2010-2014: 1,836	12.00	12.00	8.00	8.00	2.00	0.3	1	false	1	false	false	false				
40	2U	1561+65.077	1568+88.080	723.00	0.1369	2010-2014: 1,836	12.00	12.00	8.00	8.00	2.00	0.3	1	false	1	false	false	false	1,152.00	2.0	true	65

Seg. No.	Type	Start Location	End Location	Length (ft)	Length (mi)	AADT	Left Lane Width (ft)	Right Lane Width (ft)	Left Shoulder Width (ft)	Right Shoulder Width (ft)	Grade (%)	Driveway Density (driveways/mi)	Hazard Rating	Centerline Rumble Strip	Passing Lanes	TWLT Lane	Lighting	Automated Speed Enforcement	Radius (ft)	Superelevation (%)	Adverse	Design Speed (mph)
41	2U	1568+88.080	1575+49.666	661.59	0.1253	2010-2014: 1,836	12.00	12.00	8.00	8.00	7.00	0.3	1	false	1	false	false	false	1,152.00	2.0	true	65
42	2U	1575+49.666	1579+81.473	431.81	0.0818	2010-2014: 1,836	12.00	12.00	8.00	8.00	7.00	0.3	1	false	1	false	false	false				
43	2U	1579+81.473	1587+62.614	781.14	0.1479	2010-2014: 1,836	12.00	12.00	8.00	8.00	7.00	0.3	1	false	1	false	false	false	881.47	2.0	true	65
44	2U	1587+62.614	1589+20.405	157.79	0.0299	2010-2014: 1,836	12.00	12.00	8.00	8.00	7.00	0.3	1	false	1	false	false	false				
45	2U	1589+20.405	1591+85.378	264.97	0.0502	2010-2014: 1,836	12.00	12.00	8.00	8.00	3.90	0.3	1	false	1	false	false	false				
46	2U	1591+85.378	1598+89.259	703.88	0.1333	2010-2014: 1,836	12.00	12.00	8.00	8.00	3.90	0.3	1	false	1	false	false	false	825.00	2.0	true	65
47	2U	1598+89.259	1604+98.065	608.81	0.1153	2010-2014: 1,836	12.00	12.00	8.00	8.00	7.00	0.3	1	false	1	false	false	false	825.00	2.0	true	65
48	2U	1604+98.065	1609+35.192	437.13	0.0828	2010-2014: 1,836	12.00	12.00	8.00	8.00	7.00	0.3	1	false	1	false	false	false				
49	2U	1609+35.192	1610+00.000	64.81	0.0123	2010-2014: 1,836	12.00	12.00	8.00	8.00	7.00	0.3	1	false	1	false	false	false	1,041.74	2.0	true	65
50	2U	1610+00.000	1614+65.403	465.40	0.0881	2010-2014: 1,836	12.00	12.00	8.00	8.00	7.00	0.3	1	false	0	false	false	false	1,041.74	2.0	true	65
51	2U	1614+65.403	1615+65.837	100.43	0.0190	2010-2014: 1,836	12.00	12.00	8.00	8.00	7.00	0.3	1	false	0	false	false	false				
52	2U	1615+65.837	1623+55.342	789.50	0.1495	2010-2014: 1,836	12.00	12.00	8.00	8.00	0.70	0.3	1	false	0	false	false	false				
53	2U	1623+55.342	1627+06.536	351.19	0.0665	2010-2014: 1,836	12.00	12.00	8.00	8.00	0.70	0.3	1	false	0	false	false	false	3,819.72	2.0	true	65
54	2U	1627+06.536	1634+67.324	760.79	0.1441	2010-2014: 1,836	12.00	12.00	8.00	8.00	3.30	0.3	1	false	0	false	false	false	3,819.72	2.0	true	65
55	2U	1634+67.324	1643+43.433	876.11	0.1659	2010-2014: 1,836	12.00	12.00	8.00	8.00	3.30	0.3	1	false	0	false	false	false				
56	2U	1643+43.433	1658+40.396	1,496.96	0.2835	2010-2014: 1,836	12.00	12.00	8.00	8.00	3.30	0.3	1	false	0	false	false	false	2,546.48	2.0	true	65
57	2U	1658+40.396	1662+05.617	365.22	0.0692	2010-2014: 1,836	12.00	12.00	8.00	8.00	0.70	0.3	1	false	0	false	false	false	2,546.48	2.0	true	65
58	2U	1662+05.617	1671+65.038	959.42	0.1817	2010-2014: 1,836	12.00	12.00	8.00	8.00	0.70	0.3	1	false	0	false	false	false				
59	2U	1671+65.038	1674+56.874	291.84	0.0553	2010-2014: 1,836	12.00	12.00	8.00	8.00	1.30	0.3	1	false	0	false	false	false				
60	2U	1674+56.874	1681+00.000	643.13	0.1218	2010-2014: 1,836	12.00	12.00	8.00	8.00	1.30	0.3	1	false	0	false	false	false	2,864.79	2.0	true	65
61	2U	1681+00.000	1684+84.121	384.12	0.0727	2010-2014: 1,836	12.00	12.00	8.00	8.00	1.30	0.3	1	false	1	false	false	false	2,864.79	2.0	true	65
62	2U	1684+84.121	1689+55.548	471.43	0.0893	2010-2014: 1,836	12.00	12.00	8.00	8.00	1.30	0.3	1	false	1	false	false	false				
63	2U	1689+55.548	1696+91.231	735.68	0.1393	2010-2014: 1,836	12.00	12.00	8.00	8.00	1.30	0.3	1	false	1	false	false	false	2,291.83	2.0	true	65
64	2U	1696+91.231	1697+38.184	46.95	0.0089	2010-2014: 1,836	12.00	12.00	8.00	8.00	0.60	0.3	1	false	1	false	false	false	2,291.83	2.0	true	65
65	2U	1697+38.184	1703+52.875	614.69	0.1164	2010-2014: 1,836	12.00	12.00	8.00	8.00	0.60	0.3	1	false	1	false	false	false				
66	2U	1703+52.875	1708+54.649	501.77	0.0950	2010-2014: 1,836	12.00	12.00	8.00	8.00	0.60	0.3	1	false	1	false	false	false	3,819.72	2.0	true	65
67	2U	1708+54.649	1713+92.335	537.69	0.1018	2010-2014: 1,836	12.00	12.00	8.00	8.00	4.00	0.3	1	false	1	false	false	false	3,819.72	2.0	true	65
68	2U	1713+92.335	1716+89.463	297.13	0.0563	2010-2014: 1,836	12.00	12.00	8.00	8.00	4.00	0.3	1	false	1	false	false	false				
69	2U	1716+89.463	1728+08.381	1,118.92	0.2119	2010-2014: 1,836	12.00	12.00	8.00	8.00	0.50	0.3	1	false	1	false	false	false				
70	2U	1728+08.381	1731+17.025	308.64	0.0585	2010-2014: 1,836	12.00	12.00	8.00	8.00	5.30	0.3	1	false	1	false	false	false				
71	2U	1731+17.025	1736+82.212	565.19	0.1070	2010-2014: 1,836	12.00	12.00	8.00	8.00	5.30	0.3	1	false	1	false	false	false	2,150.00	2.0	true	65
72	2U	1736+82.212	1739+00.000	217.79	0.0413	2010-2014: 1,836	12.00	12.00	8.00	8.00	5.30	0.3	1	false	1	false	false	false				
73	2U	1739+00.000	1749+79.705	1,079.70	0.2045	2010-2014: 1,836	12.00	12.00	8.00	8.00	5.30	0.3	1	false	0	false	false	false				
74	2U	1749+79.705	1750+54.678	74.97	0.0142	2010-2014: 1,836	12.00	12.00	8.00	8.00	5.30	0.3	1	false	0	false	false	false	1,950.00	2.0	true	65
75	2U	1750+54.678	1754+00.000	345.32	0.0654	2010-2014: 1,836	12.00	12.00	8.00	8.00	4.60	0.3	1	false	0	false	false	false	1,950.00	2.0	true	65
76	2U	1754+00.000	1756+47.361	247.36	0.0469	2010-2014: 1,836	12.00	12.00	8.00	8.00	4.60	0.3	1	false	1	false	false	false	1,950.00	2.0	true	65
77	2U	1756+47.361	1761+94.171	546.81	0.1036	2010-2014: 1,836	12.00	12.00	8.00	8.00	4.60	0.3	1	false	1	false	false	false				
78	2U	1761+94.171	1764+68.438	274.27	0.0519	2010-2014: 1,836	12.00	12.00	8.00	8.00	4.60	0.3	1	false	1	false	false	false	5,800.00	2.0	true	65
79	2U	1764+68.438	1769+37.986	469.55	0.0889	2010-2014: 1,836	12.00	12.00	8.00	8.00	5.00	0.3	1	false	1	false	false	false	5,800.00	2.0	true	65
80	2U	1769+37.986	1786+03.032	1,665.05	0.3154	2010-2014: 1,836	12.00	12.00	8.00	8.00	5.00	0.3	1	false	1	false	false	false				
81	2U	1786+03.032	1796+26.415	1,023.38	0.1938	2010-2014: 1,836	12.00	12.00	8.00	8.00	0.30	0.3	1	false	1	false	false	false				
82	2U	1796+26.415	1801+11.457	485.04	0.0919	2010-2014: 1,836	12.00	12.00	8.00	8.00	0.30	0.3	1	false	1	false	false	false	5,729.58	2.0	true	65
83	2U	1801+11.457	1803+66.390	254.93	0.0483	2010-2014: 1,836	12.00	12.00	8.00	8.00	0.30	0.3	1	false	1	false	false	false				

Seg. No.	Type	Start Location	End Location	Length (ft)	Length (mi)	AADT	Left Lane Width (ft)	Right Lane Width (ft)	Left Shoulder Width (ft)	Right Shoulder Width (ft)	Grade (%)	Driveway Density (driveways/mi)	Hazard Rating	Centerline Rumble Strip	Passing Lanes	TWLT Lane	Lighting	Automated Speed Enforcement	Radius (ft)	Superelevation (%)	Adverse	Design Speed (mph)
84	2U	1803+66.390	1814+09.517	1,043.13	0.1976	2010-2014: 1,836	12.00	12.00	8.00	8.00	4.90	0.3	1	false	1	false	false	false				
85	2U	1814+09.517	1819+97.464	587.95	0.1114	2010-2014: 1,836	12.00	12.00	8.00	8.00	4.90	0.3	1	false	1	false	false	false	1,450.00	2.0	true	65
86	2U	1819+97.464	1820+48.062	50.60	0.0096	2010-2014: 1,836	12.00	12.00	8.00	8.00	4.90	0.3	1	false	1	false	false	false				
87	2U	1820+48.062	1824+53.898	405.84	0.0769	2010-2014: 1,836	12.00	12.00	8.00	8.00	1.70	0.3	1	false	1	false	false	false				
88	2U	1824+53.898	1826+89.465	235.57	0.0446	2010-2014: 1,836	12.00	12.00	8.00	8.00	1.70	0.3	1	false	1	false	false	false	3,000.00	2.0	true	65
89	2U	1826+89.465	1830+41.880	352.42	0.0668	2010-2014: 1,836	12.00	12.00	8.00	8.00	5.00	0.3	1	false	1	false	false	false	3,000.00	2.0	true	65
90	2U	1830+41.880	1836+58.064	616.18	0.1167	2010-2014: 1,836	12.00	12.00	8.00	8.00	5.00	0.3	1	false	1	false	false	false				
91	2U	1836+58.064	1841+90.386	532.32	0.1008	2010-2014: 1,836	12.00	12.00	8.00	8.00	5.00	0.3	1	false	1	false	false	false	1,160.00	2.0	true	65
92	2U	1841+90.386	1844+74.496	284.11	0.0538	2010-2014: 1,836	12.00	12.00	8.00	8.00	4.00	0.3	1	false	1	false	false	false	1,160.00	2.0	true	65
93	2U	1844+74.496	1849+15.104	440.61	0.0834	2010-2014: 1,836	12.00	12.00	8.00	8.00	4.00	0.3	1	false	1	false	false	false				
94	2U	1849+15.104	1858+04.945	889.84	0.1685	2010-2014: 1,836	12.00	12.00	8.00	8.00	4.00	0.3	1	false	1	false	false	false	825.00	2.0	true	65
95	2U	1858+04.945	1869+49.895	1,144.95	0.2168	2010-2014: 1,836	12.00	12.00	8.00	8.00	4.00	0.3	1	false	1	false	false	false				
96	2U	1869+49.895	1875+20.742	570.85	0.1081	2010-2014: 1,836	12.00	12.00	8.00	8.00	4.00	0.3	1	false	1	false	false	false	1,909.86	2.0	true	65
97	2U	1875+20.742	1887+50.279	1,229.54	0.2329	2010-2014: 1,836	12.00	12.00	8.00	8.00	4.00	0.3	1	false	1	false	false	false				
98	2U	1887+50.279	1899+00.000	1,149.72	0.2177	2010-2014: 1,836	12.00	12.00	8.00	8.00	3.20	0.3	1	false	1	false	false	false				
99	2U	1899+00.000	1902+52.815	352.81	0.0668	2010-2014: 1,836	12.00	12.00	8.00	8.00	3.20	0.3	1	false	0	false	false	false				
100	2U	1902+52.815	1908+15.543	562.73	0.1066	2010-2014: 1,836	12.00	12.00	8.00	8.00	3.20	0.3	1	false	0	false	false	false	1,980.00	2.0	true	55
101	2U	1908+15.543	1912+56.122	440.58	0.0834	2010-2014: 1,836	12.00	12.00	8.00	8.00	3.20	0.3	1	false	0	false	false	false				
102	2U	1912+56.122	1922+09.301	953.18	0.1805	2010-2014: 1,836	12.00	12.00	8.00	8.00	3.20	0.3	1	false	0	false	false	false	1,909.86	2.0	true	55
103	2U	1922+09.301	1923+07.672	98.37	0.0186	2010-2014: 1,836	12.00	12.00	8.00	8.00	0.16	0.3	1	false	0	false	false	false	1,909.86	2.0	true	55
104	2U	1923+07.672	1942+90.110	1,982.44	0.3755	2010-2014: 1,836	12.00	12.00	8.00	8.00	0.16	0.3	1	false	0	false	false	false				
105	2U	1942+90.110	1951+68.332	878.22	0.1663	2010-2014: 1,836	12.00	12.00	8.00	8.00	4.20	0.3	1	false	0	false	false	false				
106	2U	1951+68.332	1991+05.968	3,937.64	0.7458	2010-2014: 1,836	12.00	12.00	8.00	8.00	1.30	0.3	1	false	0	false	false	false				
107	2U	1991+05.968	2014+85.473	2,379.51	0.4507	2010-2014: 1,836	12.00	12.00	8.00	8.00	5.00	0.3	1	false	0	false	false	false				
108	2U	2014+85.473	2044+63.612	2,978.14	0.5640	2010-2014: 1,836	12.00	12.00	8.00	8.00	5.00	0.3	1	false	0	false	false	false				
109	2U	2044+63.612	2061+78.629	1,715.02	0.3248	2010-2014: 1,836	12.00	12.00	8.00	8.00	0.30	0.3	1	false	0	false	false	false				
110	2U	2061+78.629	2070+98.406	919.78	0.1742	2010-2014: 1,836	12.00	12.00	8.00	8.00	0.80	0.3	1	false	0	false	false	false				
111	2U	2070+98.406	2084+39.972	1,341.57	0.2541	2010-2014: 1,836	12.00	12.00	8.00	8.00	0.80	0.3	1	false	0	false	false	false	5,729.58	2.0	true	55
112	2U	2084+39.972	2086+40.102	200.13	0.0379	2010-2014: 1,836	12.00	12.00	8.00	8.00	2.00	0.3	1	false	0	false	false	false	5,729.58	2.0	true	55
113	2U	2086+40.102	2099+74.790	1,334.69	0.2528	2010-2014: 1,836	12.00	12.00	8.00	8.00	2.00	0.3	1	false	0	false	false	false				
114	2U	2099+74.790	2111+43.919	1,169.13	0.2214	2010-2014: 1,836	12.00	12.00	8.00	8.00	1.40	0.3	1	false	0	false	false	false				
115	2U	2111+43.919	2120+81.651	937.73	0.1776	2010-2014: 1,836	12.00	12.00	8.00	8.00	0.40	0.3	1	false	0	false	false	false				
116	2U	2120+81.651	2129+87.830	906.18	0.1716	2010-2014: 1,836	12.00	12.00	8.00	8.00	2.30	0.3	1	false	0	false	false	false				
117	2U	2129+87.830	2140+56.643	1,068.81	0.2024	2010-2014: 1,836	12.00	12.00	8.00	8.00	0.38	0.3	1	false	0	false	false	false				
118	2U	2140+56.643	2142+74.256	217.61	0.0412	2010-2014: 1,836	12.00	12.00	8.00	8.00	0.38	0.3	1	false	0	false	false	false	5,729.58	2.0	true	55
119	2U	2142+74.256	2168+08.627	2,534.37	0.4800	2010-2014: 1,836	12.00	12.00	8.00	8.00	2.00	0.3	1	false	0	false	false	false	5,729.58	2.0	true	55
120	2U	2168+08.627	2182+78.204	1,469.58	0.2783	2010-2014: 1,836	12.00	12.00	8.00	8.00	2.30	0.3	1	false	0	false	false	false	5,729.58	2.0	true	55
121	2U	2182+78.204	2183+26.113	47.91	0.0091	2010-2014: 1,836	12.00	12.00	8.00	8.00	3.00	0.3	1	false	0	false	false	false	5,729.58	2.0	true	55
122	2U	2183+26.113	2199+41.672	1,615.56	0.3060	2010-2014: 1,836	12.00	12.00	8.00	8.00	3.00	0.3	1	false	0	false	false	false				
123	2U	2199+41.672	2201+13.109	171.44	0.0325	2010-2014: 1,836	12.00	12.00	8.00	8.00	1.90	0.3	1	false	0	false	false	false				
124	2U	2201+13.109	2210+46.999	933.89	0.1769	2010-2014: 1,836	12.00	12.00	8.00	8.00	1.90	0.3	1	false	0	false	false	false	2,864.79	2.0	true	55
125	2U	2210+46.999	2224+50.778	1,403.78	0.2659	2010-2014: 1,836	12.00	12.00	8.00	8.00	1.90	0.3	1	false	0	false	false	false				
126	2U	2224+50.778	2238+41.687	1,390.91	0.2634	2010-2014: 1,836	12.00	12.00	8.00	8.00	0.50	0.3	1	false	0	false	false	false				

Seg. No.	Type	Start Location	End Location	Length (ft)	Length (mi)	AADT	Left Lane Width (ft)	Right Lane Width (ft)	Left Shoulder Width (ft)	Right Shoulder Width (ft)	Grade (%)	Driveway Density (driveways/mi)	Hazard Rating	Centerline Rumble Strip	Passing Lanes	TWLT Lane	Lighting	Automated Speed Enforcement	Radius (ft)	Superelevation (%)	Adverse	Design Speed (mph)
127	2U	2238+41.687	2252+38.958	1,397.27	0.2646	2010-2014: 1,836	12.00	12.00	8.00	8.00	2.50	0.3	1	false	0	false	false	false				
128	2U	2252+38.958	2253+13.131	74.17	0.0140	2010-2014: 1,836	12.00	12.00	8.00	8.00	2.50	0.3	1	false	0	false	false	false	2,788.71	2.0	true	55
129	2U	2253+13.131	2267+68.359	1,455.23	0.2756	2010-2014: 1,836	12.00	12.00	8.00	8.00	1.70	0.3	1	false	0	false	false	false	2,788.71	2.0	true	55
130	2U	2267+68.359	2271+18.026	349.67	0.0662	2010-2014: 1,836	12.00	12.00	8.00	8.00	1.70	0.3	1	false	0	false	false	false				
131	2U	2271+18.026	2275+17.825	399.80	0.0757	2010-2014: 1,836	12.00	12.00	8.00	8.00	3.50	0.3	1	false	0	false	false	false				
132	2U	2275+17.825	2283+86.397	868.57	0.1645	2010-2014: 1,836	12.00	12.00	8.00	8.00	3.50	0.3	1	false	0	false	false	false	2,788.71	2.0	true	55
133	2U	2283+86.397	2294+34.169	1,047.77	0.1984	2010-2014: 1,836	12.00	12.00	8.00	8.00	0.60	0.3	1	false	0	false	false	false	2,788.71	2.0	true	55
134	2U	2294+34.169	2297+86.147	351.98	0.0667	2010-2014: 1,836	12.00	12.00	8.00	8.00	0.00	0.3	1	false	0	false	false	false	2,788.71	2.0	true	55
135	2U	2297+86.147	2322+20.021	2,433.87	0.4610	2010-2014: 1,836	12.00	12.00	8.00	8.00	0.00	0.3	1	false	0	false	false	false				
136	2U	2322+20.021	2324+46.955	226.93	0.0430	2010-2014: 1,836	12.00	12.00	8.00	8.00	0.50	0.3	1	false	0	false	false	false				
137	2U	2324+46.955	2328+02.518	355.56	0.0673	2010-2014: 1,836	12.00	12.00	8.00	8.00	0.50	0.3	1	false	0	false	false	false	2,864.09	2.0	true	55
138	2U	2328+02.518	2335+97.505	794.99	0.1506	2010-2014: 1,836	12.00	12.00	8.00	8.00	0.00	0.3	1	false	0	false	false	false	2,864.09	2.0	true	55
139	2U	2335+97.505	2358+28.150	2,230.64	0.4225	2010-2014: 1,836	12.00	12.00	8.00	8.00	0.00	0.3	1	false	0	false	false	false				
140	2U	2358+28.150	2388+01.647	2,973.50	0.5632	2010-2014: 1,836	12.00	12.00	8.00	8.00	0.14	0.3	1	false	0	false	false	false				
141	2U	2388+01.647	2392+62.777	461.13	0.0873	2010-2014: 1,836	12.00	12.00	8.00	8.00	0.14	0.3	1	false	0	false	false	false	1,909.86	2.0	true	55
142	2U	2392+62.777	2393+97.841	135.06	0.0256	2010-2014: 1,836	12.00	12.00	8.00	8.00	1.70	0.3	1	false	0	false	false	false	1,909.86	2.0	true	55
143	2U	2393+97.841	2399+08.519	510.68	0.0967	2010-2014: 1,836	12.00	12.00	8.00	8.00	1.70	0.3	1	false	0	false	false	false				
144	2U	2399+08.519	2406+75.288	766.77	0.1452	2010-2014: 1,836	12.00	12.00	8.00	8.00	1.70	0.3	1	false	0	false	false	false	1,145.92	2.0	true	55
145	2U	2406+75.288	2410+56.262	380.97	0.0722	2010-2014: 1,836	12.00	12.00	8.00	8.00	0.20	0.3	1	false	0	false	false	false	1,145.92	2.0	true	55
146	2U	2410+56.262	2413+31.488	275.23	0.0521	2010-2014: 1,836	12.00	12.00	8.00	8.00	0.20	0.3	1	false	0	false	false	false				
147	2U	2413+31.488	2415+67.769	236.28	0.0447	2010-2014: 1,836	12.00	12.00	8.00	8.00	1.00	0.3	1	false	0	false	false	false				
148	2U	2415+67.769	2417+66.491	198.72	0.0376	2010-2014: 1,836	12.00	12.00	8.00	8.00	1.00	0.3	1	false	0	false	false	false	1,145.91	2.0	true	55
149	2U	2417+66.491	2419+57.000	190.51	0.0361	2010-2014: 1,836	12.00	12.00	8.00	8.00	0.00	0.3	1	false	0	false	false	false	1,145.91	2.0	true	55
150	2U	2419+57.000	2426+42.114	685.11	0.1298	2010-2014: 1,836	12.00	12.00	8.00	8.00	0.00	0.3	1	false	0	false	false	false	1,145.91	2.0	true	55
151	2U	2426+42.114	2459+72.548	3,330.43	0.6308	2010-2014: 1,836	12.00	12.00	8.00	8.00	0.00	0.3	1	false	0	false	false	false				
152	2U	2459+72.548	2466+78.556	706.01	0.1337	2010-2014: 1,836	12.00	12.00	8.00	8.00	0.00	0.3	1	false	0	false	false	false	1,912.94	2.0	true	55
153	2U	2466+78.556	2468+95.436	216.88	0.0411	2010-2014: 1,836	12.00	12.00	8.00	8.00	0.00	0.3	1	false	0	false	false	false				



**Table 4. Expected Highway Crash Rates and Frequencies (Section 1)**

<b>First Year of Analysis</b>	2017
<b>Last Year of Analysis</b>	2017
<b>Evaluated Length (mi)</b>	21.6264
<b>Average Future Road AADT (vpd)</b>	1,800
<b>Expected Crashes</b>	
<b>Total Crashes</b>	8.25
<b>Fatal and Injury Crashes</b>	2.84
<b>Property-Damage-Only Crashes</b>	5.41
<b>Percent of Total Expected Crashes</b>	
<b>Percent Fatal and Injury Crashes (%)</b>	34
<b>Percent Property-Damage-Only Crashes (%)</b>	66
<b>Expected Crash Rate</b>	
<b>Crash Rate (crashes/mi/yr)</b>	0.3815
<b>Fatal and Injury Crash Rate (crashes/mi/yr)</b>	0.1315
<b>Property-Damage-Only Crash Rate (crashes/mi/yr)</b>	0.2500
<b>Expected Travel Crash Rate</b>	
<b>Total Travel (million veh-mi)</b>	14.21
<b>Travel Crash Rate (crashes/million veh-mi)</b>	0.58
<b>Travel Fatal and Injury Crash Rate (crashes/million veh-mi)</b>	0.20
<b>Travel Property-Damage-Only Crash Rate (crashes/million veh-mi)</b>	0.38

**Table 5. Expected Crash Frequencies and Rates by Highway Segment (Section 1)**

<b>Segment Number/Intersection Name/Cross Road</b>	<b>Start Location</b>	<b>End Location</b>	<b>Length (mi)</b>	<b>Expected No. Crashes for Evaluation Period</b>	<b>Crash Rate (crashes/mi/yr)</b>	<b>Travel Crash Rate (crashes/million veh-mi)</b>
1	1327+09.000	1336+44.302	0.1771	0.047	0.2668	0.41
2	1336+44.302	1345+88.891	0.1789	0.057	0.3206	0.49
3	1345+88.891	1350+43.605	0.0861	0.022	0.2603	0.40
4	1350+43.605	1355+75.006	0.1006	0.037	0.3687	0.56
5	1355+75.006	1359+98.149	0.0801	0.021	0.2667	0.41
6	1359+98.149	1375+23.561	0.2889	0.091	0.3166	0.48
7	1375+23.561	1392+99.995	0.3364	0.087	0.2585	0.39
8	1392+99.995	1402+71.610	0.1840	0.052	0.2844	0.43
9	1402+71.610	1409+13.059	0.1215	0.035	0.2844	0.43
10	1409+13.059	1412+82.259	0.0699	0.025	0.3500	0.53
11	1412+82.259	1421+34.750	0.1615	0.056	0.3466	0.53

Segment Number/Intersection Name/Cross Road	Start Location	End Location	Length (mi)	Expected No. Crashes for Evaluation Period	Crash Rate (crashes/mi/yr)	Travel Crash Rate (crashes/million veh-mi)
12	1421+34.750	1425+63.830	0.0813	0.023	0.2857	0.43
13	1425+63.830	1429+14.849	0.0665	0.018	0.2668	0.41
14	1429+14.849	1434+46.905	0.1008	0.033	0.3317	0.51
15	1434+46.905	1439+70.975	0.0993	0.035	0.3514	0.54
16	1439+70.975	1446+39.840	0.1267	0.038	0.3018	0.46
17	1446+39.840	1474+21.199	0.5268	0.146	0.2774	0.42
18	1474+21.199	1482+80.502	0.1627	0.104	0.6407	0.97
19	1482+80.502	1495+04.091	0.2317	0.081	0.3493	0.53
20	1495+04.091	1497+85.714	0.0533	0.013	0.2353	0.36
21	1497+85.714	1516+97.763	0.3621	0.138	0.3810	0.58
22	1516+97.763	1524+02.290	0.1334	0.143	1.0732	1.63
23	1524+02.290	1538+60.000	0.2761	0.088	0.3179	0.48
24	1538+60.000	1540+55.785	0.0371	0.011	0.3011	0.46
25	1540+55.785	1547+00.000	0.1220	0.029	0.2401	0.37
26	1547+00.000	1547+28.434	0.0054	0.001	0.2001	0.30
27	1547+28.434	1552+44.906	0.0978	0.023	0.2373	0.36
28	1552+44.906	1601+34.699	0.9261	0.287	0.3094	0.47
29	1601+34.699	1602+00.000	0.0124	0.002	0.1978	0.30
30	1602+00.000	1607+40.000	0.1023	0.029	0.2827	0.43
31	1607+40.000	1608+61.172	0.0229	0.007	0.3062	0.47
32	1608+61.172	1609+61.022	0.0189	0.005	0.2645	0.40
33	1609+61.022	1616+84.156	0.1370	0.042	0.3073	0.47
34	1616+84.156	1627+49.440	0.2018	0.055	0.2741	0.42
35	1627+49.440	1643+09.371	0.2954	0.241	0.8169	1.24
36	1643+09.371	1646+14.198	0.0577	0.034	0.5911	0.90
37	1646+14.198	1656+49.808	0.1961	0.085	0.4306	0.66
38	1656+49.808	1658+64.069	0.0406	0.017	0.4107	0.62
39	1658+64.069	1668+91.391	0.1946	0.068	0.3478	0.53
40	1668+91.391	1674+04.477	0.0972	0.077	0.7966	1.21
41	1674+04.477	1681+04.530	0.1326	0.233	1.7583	2.68
42	1681+04.530	1681+60.000	0.0105	0.003	0.2675	0.41
43	1681+60.000	1681+76.437	0.0031	0.001	0.2675	0.41
44	1681+76.437	1684+40.000	0.0499	0.013	0.2675	0.41
45	1684+40.000	1690+03.213	0.1067	0.042	0.3965	0.60
46	1690+03.213	1691+78.561	0.0332	0.053	1.5888	2.42
47	1691+78.561	1695+61.079	0.0724	0.127	1.7477	2.66
48	1695+61.079	1701+91.852	0.1195	0.084	0.7008	1.07
49	1701+91.852	1711+10.262	0.1739	0.084	0.4833	0.74
50	1711+10.262	1715+28.063	0.0791	0.015	0.1925	0.29
51	1715+28.063	1720+93.250	0.1070	0.034	0.3127	0.48
52	1720+93.250	1727+11.379	0.1171	0.024	0.2074	0.32
53	1727+11.379	1732+47.637	0.1016	0.030	0.2925	0.45
54	1732+47.637	1734+23.268	0.0333	0.006	0.1768	0.27
55	1734+23.268	1751+94.855	0.3355	0.095	0.2841	0.43
56	1751+94.855	1769+82.986	0.3387	0.064	0.1886	0.29
57	1769+82.986	1777+26.252	0.1408	0.026	0.1837	0.28
58	1777+26.252	1787+88.934	0.2013	0.043	0.2121	0.32
59	1787+88.934	1788+00.000	0.0021	0.000	0.1885	0.29
60	1788+00.000	1788+28.379	0.0054	0.001	0.2175	0.33
61	1788+28.379	1796+40.000	0.1537	0.037	0.2390	0.36
62	1796+40.000	1796+64.739	0.0047	0.001	0.2239	0.34

Segment Number/Intersection Name/Cross Road	Start Location	End Location	Length (mi)	Expected No. Crashes for Evaluation Period	Crash Rate (crashes/mi/yr)	Travel Crash Rate (crashes/million veh-mi)
63	1796+64.739	1805+16.197	0.1613	0.064	0.3986	0.61
64	1805+16.197	1824+87.158	0.3733	0.131	0.3500	0.53
65	1824+87.158	1834+41.613	0.1808	0.069	0.3803	0.58
66	1834+41.613	1836+00.912	0.0302	0.021	0.7047	1.07
67	1836+00.912	1846+67.512	0.2020	0.066	0.3244	0.49
68	1846+67.512	1852+40.031	0.1084	0.023	0.2115	0.32
69	1852+40.031	1857+23.946	0.0917	0.028	0.3082	0.47
70	1857+23.946	1884+07.604	0.5083	0.162	0.3192	0.49
71	1884+07.604	1888+18.580	0.0778	0.033	0.4185	0.64
72	1888+18.580	1889+90.226	0.0325	0.032	0.9871	1.50
73	1889+90.226	1893+58.268	0.0697	0.045	0.6479	0.99
74	1893+58.268	1893+78.840	0.0039	0.004	0.8984	1.37
75	1893+78.840	1904+31.592	0.1994	0.152	0.7602	1.16
76	1904+31.592	1904+85.312	0.0102	0.010	0.9821	1.50
77	1904+85.312	1926+66.640	0.4131	0.191	0.4621	0.70
78	1926+66.640	1927+22.000	0.0105	0.003	0.2935	0.45
79	1927+22.000	1935+48.888	0.1566	0.035	0.2201	0.34
80	1935+48.888	1960+00.000	0.4642	0.168	0.3608	0.55
81	1960+00.000	1971+83.570	0.2242	0.087	0.3900	0.59
82	1971+83.570	1996+07.182	0.4590	0.176	0.3845	0.58
83	1996+07.182	2005+00.000	0.1691	0.036	0.2133	0.33
84	2005+00.000	2013+40.000	0.1591	0.045	0.2844	0.43
85	2013+40.000	2026+04.926	0.2396	0.068	0.2844	0.43
86	2026+04.926	2043+53.697	0.3312	0.086	0.2585	0.39
87	2043+53.697	2052+62.284	0.1721	0.046	0.2658	0.40
88	2052+62.284	2066+79.057	0.2683	0.086	0.3196	0.49
89	2066+79.057	2067+99.438	0.0228	0.007	0.3196	0.49
90	2067+99.438	2080+84.795	0.2434	0.062	0.2564	0.39
91	2080+84.795	2094+08.836	0.2508	0.066	0.2611	0.40
92	2094+08.836	2101+60.000	0.1423	0.048	0.3366	0.51
93	2101+60.000	2102+53.154	0.0176	0.010	0.5511	0.84
94	2102+53.154	2104+40.000	0.0354	0.019	0.5511	0.84
95	2104+40.000	2110+00.000	0.1061	0.059	0.5511	0.84
96	2110+00.000	2111+68.168	0.0319	0.012	0.3646	0.56
97	2111+68.168	2122+15.751	0.1984	0.074	0.3745	0.57
98	2122+15.751	2124+49.703	0.0443	0.009	0.2038	0.31
99	2124+49.703	2149+30.199	0.4698	0.094	0.2006	0.30
100	2149+30.199	2164+85.534	0.2946	0.057	0.1947	0.30
101	2164+85.534	2165+23.218	0.0071	0.001	0.1657	0.25
102	2165+23.218	2180+30.331	0.2854	0.052	0.1823	0.28
103	2180+30.331	2182+72.331	0.0458	0.008	0.1657	0.25
104	2182+72.331	2192+06.289	0.1769	0.132	0.7454	1.14
105	2192+06.289	2205+63.286	0.2570	0.099	0.3861	0.59
106	2205+63.286	2215+00.000	0.1774	0.043	0.2398	0.36
107	2215+00.000	2218+86.582	0.0732	0.037	0.5036	0.77
108	2218+86.582	2220+60.000	0.0328	0.017	0.5036	0.77
109	2220+60.000	2223+43.040	0.0536	0.027	0.5036	0.77
110	2223+43.040	2233+97.851	0.1998	0.101	0.5056	0.77
111	2233+97.851	2235+36.760	0.0263	0.017	0.6609	1.01
112	2235+36.760	2249+27.960	0.2635	0.110	0.4172	0.64
113	2249+27.960	2252+53.753	0.0617	0.016	0.2659	0.40

Segment Number/Intersection Name/Cross Road	Start Location	End Location	Length (mi)	Expected No. Crashes for Evaluation Period	Crash Rate (crashes/mi/yr)	Travel Crash Rate (crashes/million veh-mi)
114	2252+53.753	2256+76.507	0.0801	0.022	0.2707	0.41
115	2256+76.507	2264+25.664	0.1419	0.049	0.3468	0.53
116	2264+25.664	2279+45.879	0.2879	0.093	0.3230	0.49
117	2279+45.879	2306+05.945	0.5038	0.170	0.3364	0.51
118	2306+05.945	2317+56.861	0.2180	0.157	0.7180	1.09
119	2317+56.861	2369+38.765	0.9814	0.444	0.4521	0.69
120	2369+38.765	2374+65.324	0.0997	0.071	0.7134	1.09
121	2374+65.324	2375+78.706	0.0215	0.015	0.7134	1.09
122	2375+78.706	2380+67.835	0.0926	0.045	0.4904	0.75
123	2380+67.835	2386+97.264	0.1192	0.088	0.7346	1.12
124	2386+97.264	2392+14.656	0.0980	0.114	1.1652	1.77
125	2392+14.656	2395+38.442	0.0613	0.021	0.3397	0.52
126	2395+38.442	2397+27.128	0.0357	0.009	0.2668	0.41
127	2397+27.128	2398+49.027	0.0231	0.009	0.4043	0.61
128	2398+49.027	2400+99.997	0.0475	0.017	0.3621	0.55
129	2400+99.997	2408+00.619	0.1327	0.046	0.3487	0.53
130	2408+00.619	2441+31.129	0.6308	0.267	0.4231	0.64
131	2441+31.129	2448+37.898	0.1339	0.052	0.3880	0.59
132	2448+37.898	2468+96.256	0.3898	0.100	0.2551	0.39

**Table 6. Expected Crash Frequencies and Rates by Horizontal Design Element (Section 1)**

Title	Start Location	End Location	Length (mi)	Expected No. Crashes for Evaluation Period	Crash Rate (crashes/mi/yr)	Travel Crash Rate (crashes/million veh-mi)
Tangent	1327+09.000	1336+44.302	0.1771	0.047	0.2668	0.41
Simple Curve 1	1336+44.302	1345+88.891	0.1789	0.057	0.3206	0.49
Tangent	1345+88.891	1350+43.605	0.0861	0.022	0.2603	0.40
Simple Curve 2	1350+43.605	1355+75.006	0.1006	0.037	0.3687	0.56
Tangent	1355+75.006	1359+98.149	0.0801	0.021	0.2667	0.41
Simple Curve 3	1359+98.149	1375+23.561	0.2889	0.091	0.3166	0.48
Tangent	1375+23.561	1409+13.059	0.6420	0.174	0.2708	0.41
Simple Curve 4	1409+13.059	1421+34.750	0.2314	0.080	0.3476	0.53
Tangent	1421+34.750	1429+14.849	0.1477	0.041	0.2772	0.42
Simple Curve 5	1429+14.849	1439+70.975	0.2000	0.068	0.3414	0.52
Tangent	1439+70.975	1482+80.502	0.8162	0.289	0.3536	0.54
Simple Curve 6	1482+80.502	1495+04.091	0.2317	0.081	0.3493	0.53
Tangent	1495+04.091	1516+97.763	0.4155	0.150	0.3623	0.55
Simple Curve 7	1516+97.763	1540+55.785	0.4466	0.242	0.5422	0.82
Tangent	1540+55.785	1547+28.434	0.1274	0.030	0.2385	0.36
Simple Curve 8	1547+28.434	1601+34.699	1.0239	0.310	0.3026	0.46
Tangent	1601+34.699	1609+61.022	0.1565	0.043	0.2773	0.42
Simple Curve 9	1609+61.022	1616+84.156	0.1370	0.042	0.3073	0.47
Tangent	1616+84.156	1627+49.440	0.2018	0.055	0.2741	0.42
Simple Curve 10	1627+49.440	1646+14.198	0.3532	0.276	0.7800	1.19
Tangent	1646+14.198	1658+64.069	0.2367	0.101	0.4272	0.65
Simple Curve 11	1658+64.069	1668+91.391	0.1946	0.068	0.3478	0.53

Title	Start Location	End Location	Length (mi)	Expected No. Crashes for Evaluation Period	Crash Rate (crashes/mi/yr)	Travel Crash Rate (crashes/million veh-mi)
Tangent	1668+91.391	1674+04.477	0.0972	0.077	0.7966	1.21
Simple Curve 12	1674+04.477	1681+04.530	0.1326	0.233	1.7583	2.68
Tangent	1681+04.530	1690+03.213	0.1702	0.059	0.3483	0.53
Simple Curve 13	1690+03.213	1695+61.079	0.1057	0.179	1.6978	2.58
Tangent	1695+61.079	1715+28.063	0.3725	0.183	0.4913	0.75
Simple Curve 14	1715+28.063	1720+93.250	0.1070	0.034	0.3127	0.48
Tangent	1720+93.250	1727+11.379	0.1171	0.024	0.2074	0.32
Simple Curve 15	1727+11.379	1732+47.637	0.1016	0.030	0.2925	0.45
Tangent	1732+47.637	1777+26.252	0.8482	0.191	0.2251	0.34
Simple Curve 16	1777+26.252	1787+88.934	0.2013	0.043	0.2121	0.32
Tangent	1787+88.934	1796+64.739	0.1659	0.039	0.2373	0.36
Simple Curve 17	1796+64.739	1805+16.197	0.1613	0.064	0.3986	0.61
Tangent	1805+16.197	1836+00.912	0.5842	0.221	0.3777	0.57
Simple Curve 18	1836+00.912	1846+67.512	0.2020	0.066	0.3244	0.49
Tangent	1846+67.512	1852+40.031	0.1084	0.023	0.2115	0.32
Simple Curve 19	1852+40.031	1857+23.946	0.0917	0.028	0.3082	0.47
Tangent	1857+23.946	1884+07.604	0.5083	0.162	0.3192	0.49
Simple Curve 20	1884+07.604	1889+90.226	0.1103	0.065	0.5860	0.89
Tangent	1889+90.226	1893+58.268	0.0697	0.045	0.6479	0.99
Simple Curve 21	1893+58.268	1904+85.312	0.2135	0.165	0.7733	1.18
Tangent	1904+85.312	2052+62.284	2.7987	0.941	0.3361	0.51
Simple Curve 22	2052+62.284	2067+99.438	0.2911	0.093	0.3196	0.49
Tangent	2067+99.438	2122+15.751	1.0258	0.349	0.3406	0.52
Simple Curve 23	2122+15.751	2164+85.534	0.8087	0.161	0.1986	0.30
Tangent	2164+85.534	2182+72.331	0.3384	0.061	0.1797	0.27
Simple Curve 24	2182+72.331	2192+06.289	0.1769	0.132	0.7454	1.14
Tangent	2192+06.289	2233+97.851	0.7939	0.323	0.4071	0.62
Simple Curve 25	2233+97.851	2249+27.960	0.2898	0.127	0.4393	0.67
Tangent	2249+27.960	2256+76.507	0.1418	0.038	0.2686	0.41
Simple Curve 26	2256+76.507	2279+45.879	0.4298	0.142	0.3309	0.50
Tangent	2279+45.879	2306+05.945	0.5038	0.170	0.3364	0.51
Simple Curve 27	2306+05.945	2317+56.861	0.2180	0.157	0.7180	1.09
Tangent	2317+56.861	2369+38.765	0.9814	0.444	0.4521	0.69
Simple Curve 28	2369+38.765	2375+78.706	0.1212	0.086	0.7134	1.09
Tangent	2375+78.706	2380+67.835	0.0926	0.045	0.4904	0.75
Simple Curve 29	2380+67.835	2392+14.656	0.2172	0.202	0.9288	1.41
Tangent	2392+14.656	2397+27.128	0.0971	0.030	0.3129	0.48
Simple Curve 30	2397+27.128	2408+00.619	0.2033	0.073	0.3582	0.55
Tangent	2408+00.619	2441+31.129	0.6308	0.267	0.4231	0.64
Simple Curve 31	2441+31.129	2448+37.898	0.1339	0.052	0.3880	0.59
Tangent	2448+37.898	2468+96.256	0.3898	0.100	0.2551	0.39

**Table 7. Expected Segment Crash Type Distribution (Section 1)**

Element Type	Crash Type	FI Crashes	Percent FI (%)	PDO Crashes	Percent PDO (%)	Total Crashes	Percent Total (%)
Highway Segment	Collision with Animal	0.11	1.3	0.99	12.1	1.00	12.1
Highway Segment	Collision with Bicycle	0.01	0.1	0.01	0.1	0.02	0.2
Highway Segment	Other Single-vehicle Collision	0.02	0.2	0.16	1.9	0.17	2.1
Highway Segment	Overtaken	0.10	1.3	0.08	1.0	0.21	2.5
Highway Segment	Collision with Pedestrian	0.02	0.2	0.01	0.1	0.03	0.3
Highway Segment	Run Off Road	1.55	18.8	2.73	33.1	4.30	52.1
Highway Segment	Total Single Vehicle Crashes	1.81	22.0	3.97	48.2	5.72	69.3
Highway Segment	Angle Collision	0.29	3.5	0.39	4.7	0.70	8.5
Highway Segment	Head-on Collision	0.10	1.2	0.02	0.2	0.13	1.6
Highway Segment	Other Multiple-vehicle Collision	0.07	0.9	0.16	2.0	0.22	2.7
Highway Segment	Rear-end Collision	0.47	5.7	0.66	8.0	1.17	14.2
Highway Segment	Sideswipe	0.11	1.3	0.20	2.5	0.30	3.7
Highway Segment	Total Multiple Vehicle Crashes	1.03	12.5	1.43	17.4	2.53	30.7
Highway Segment	Total Highway Segment Crashes	2.85	34.5	5.41	65.5	8.25	100.0
	Total Crashes	2.85	34.5	5.41	65.5	8.25	100.0

**Note:** *Fatal and Injury Crashes* and *Property Damage Only Crashes* do not necessarily sum up to *Total Crashes* because the distribution of these three crashes had been derived independently.

*Interactive Highway Safety Design Model*

**Crash Prediction Evaluation Report**

**P1\_6 Alignment Alternative**

January 18, 2018





## **Disclaimer**

The Interactive Highway Design Model (IHSDM) software is disseminated under the sponsorship of the Department of Transportation in the interest of information exchange. The United States Government assumes no liability for its content or use thereof. This document does not constitute a standard, specification, or regulation.

The United States Government does not endorse products or manufacturers. Trade and manufacturers' names may appear in this software and documentation only because they are considered essential to the objective of the software.

## **Limited Warranty and Limitations of Remedies**

This software product is provided "as-is," without warranty of any kind-either expressed or implied (but not limited to the implied warranties of merchantability and fitness for a particular purpose). The FHWA do not warrant that the functions contained in the software will meet the end-user's requirements or that the operation of the software will be uninterrupted and error-free.

Under no circumstances will the FHWA be liable to the end-user for any damages or claimed lost profits, lost savings, or other incidental or consequential damages rising out of the use or inability to use the software (even if these organizations have been advised of the possibility of such damages), or for any claim by any other party.

## **Notice**

The use of the IHSDM software is being done strictly on a voluntary basis. In exchange for provision of IHSDM, the user agrees that the Federal Highway Administration (FHWA), U.S. Department of Transportation and any other agency of the Federal Government shall not be responsible for any errors, damage or other liability that may result from any and all use of the software, including installation and testing of the software. The user further agrees to hold the FHWA and the Federal Government harmless from any resulting liability. The user agrees that this hold harmless provision shall flow to any person to whom or any entity to which the user provides the IHSDM software. It is the user's full responsibility to inform any person to whom or any entity to which it provides the IHSDM software of this hold harmless provision.

---

---

**Table of Contents**

**Report Overview** ..... **1**  
**Section 1 Evaluation** ..... **2**

**List of Tables**

Table Observed Crashes Used in the Evaluation (Section 1) ..... 3  
Table Evaluation Highway - Homogeneous Segments (Section 1) ..... 4  
Table Crash History Highway - Homogeneous Segments (Section 1) ..... 7  
Table Expected Highway Crash Rates and Frequencies (Section 1) ..... 13  
Table Expected Crash Frequencies and Rates by Highway Segment (Section 1) ..... 13  
Table Expected Crash Frequencies and Rates by Horizontal Design Element (Section 1) ..... 16  
Table Expected Segment Crash Type Distribution (Section 1) ..... 18

**List of Figures**

Figure Crash Prediction Summary (Section 1) ..... 2

## Report Overview

**Report Generated:** Jan 18, 2018 8:45 AM

**Report Template:** System: Multi-Page, 508 Compliant [System] (mlcpm4, Oct 9, 2017 1:45 PM)

**Evaluation Date:** Tue Jan 16 15:55:37 AKST 2018

**IHSDM Version:** v13.0.0 (Sep 13, 2017)

**Crash Prediction Module:** v8.0.0 (Sep 13, 2017)

**User Name:** RaeAnne Hebnes

**Organization Name:** Michael Baker International

**Phone:**

**E-Mail:**

**Project Title:** Parks 305 - 325 v2

**Project Comment:** Created using wizard

**Project Unit System:** U.S. Customary

**Highway Title:** Alignment P1\_6\_1dec2017

**Highway Comment:** Alignment P1\_1dec2017with 6% max grade

**Highway Version:** 1

**Evaluation Title:** Evaluation 10

**Evaluation Comment:** Created Tue Jan 16 15:53:49 AKST 2018

**Minimum Station:** 1327+09.000

**Maximum Station:** 2469+47.035

**Policy for Superelevation:** AASHTO 2011 U.S. Customary

**Calibration:** HSM Configuration

**Crash Distribution:** HSM Configuration

**Model/CMF:** HSM Configuration

**Empirical-Bayes Analysis:** Site-Specific

**Highway with Crash History:** Alignment ParksHwy304-326 Asbuilt - 60 mph

**Highway with Crash History Comment:** Created By Civil Geometry

**Highway with Crash History Version:** 1

**First Year of Analysis:** 2017

**Last Year of Analysis:** 2017

# Section 1 Evaluation

**Section:** Section 1  
**Evaluation Start Location:** 1327+09.000  
**Evaluation End Location:** 2469+47.035  
**Area Type:** Rural  
**Functional Class:** Arterial  
**Type of Alignment:** Undivided, Two Lane  
**Model Category:** Rural, Two Lane  
**Calibration Factor:** 2U=1.0;

Crash Prediction Summary, Section 1 (Undivided, Two Lane; Rural; Arterial)  
 Project: Parks 305 - 325 v2, Evaluation: Evaluation 10  
 Highway: Alignment P1\_6\_1dec2017

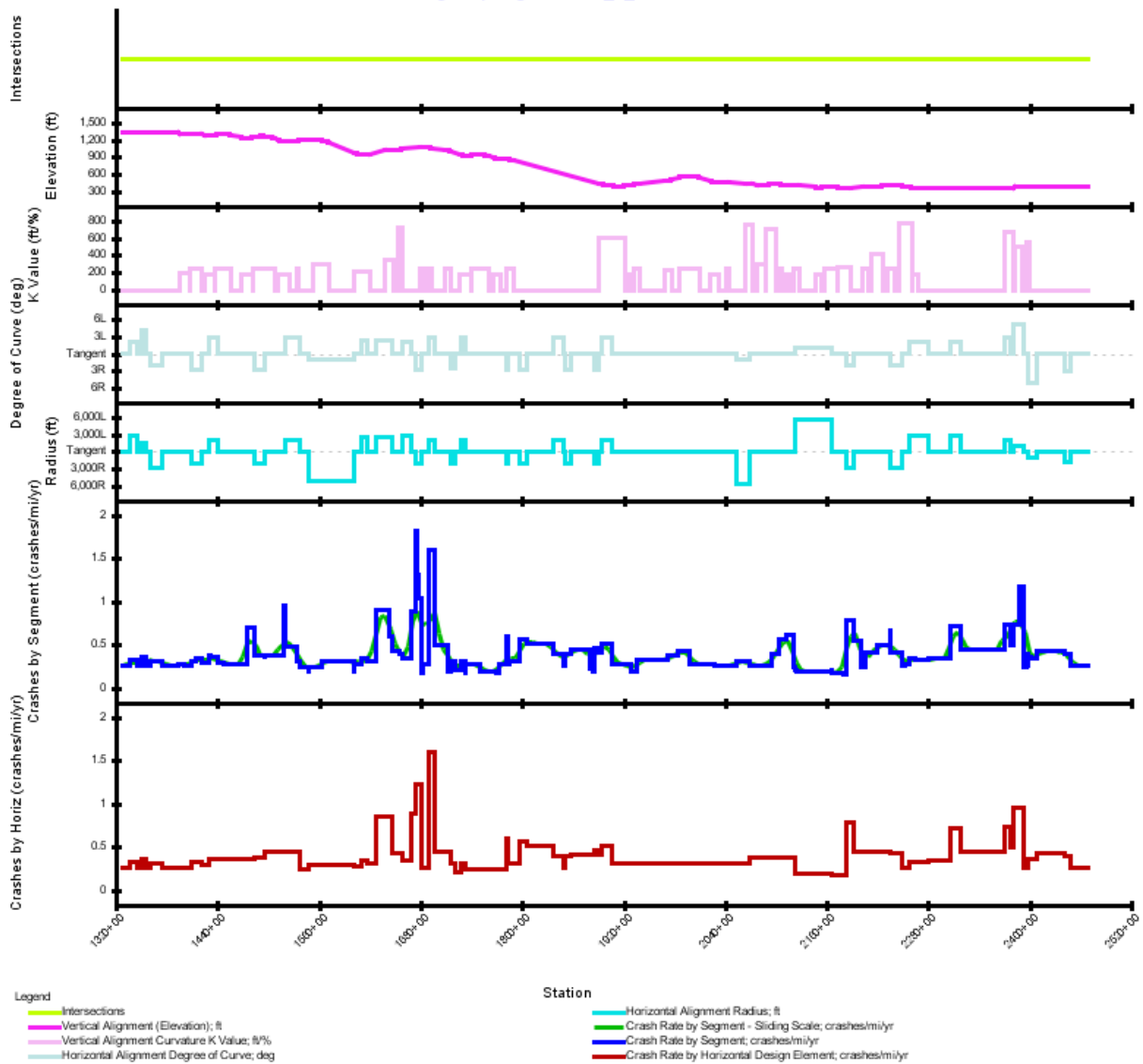

Figure 1. Crash Prediction Summary (Section 1)

**Table 1. Observed Crashes Used in the Evaluation (Section 1)**

Year	Observed Crashes	Total Crashes Used	FI Crashes	FI no/C Crashes	PDO Crashes
2010	9	7	3	1	4
2011	6	6	2	0	4
2012	7	7	2	0	5
2013	6	6	3	0	3
2014	17	16	7	0	9
All Years	45 &nbsp; <sup>[1]</sup>	42	17	1	25

**Footnotes**

<sup>[1]</sup> Note: Observed crash data that does not comply with the associated CPM model requirements may not be used in EB processing.

**Table 2. Evaluation Highway - Homogeneous Segments (Section 1)**

Seg. No.	Type	Start Location	End Location	Length (ft)	Length (mi)	AADT	Left Lane Width (ft)	Right Lane Width (ft)	Left Shoulder Width (ft)	Right Shoulder Width (ft)	Grade (%)	Driveway Density (driveways/mi)	Hazard Rating	Centerline Rumble Strip	Passing Lanes	TWLT Lane	Lighting	Automated Speed Enforcement	Radius (ft)	Superelevation (%)	Adverse	Design Speed (mph)
1	2U	1327+09.000	1336+44.302	935.30	0.1771	2017: 1,800	12.00	12.00	8.00	8.00	0.00	0.3	1	false	0	false	false	false				
2	2U	1336+44.302	1345+88.891	944.59	0.1789	2017: 1,800	12.00	12.00	8.00	8.00	0.00	0.3	1	false	0	false	false	false	2,864.79	2.0	true	70
3	2U	1345+88.891	1350+43.605	454.71	0.0861	2017: 1,800	12.00	12.00	8.00	8.00	0.00	0.3	1	false	0	false	false	false				
4	2U	1350+43.605	1355+75.006	531.40	0.1006	2017: 1,800	12.00	12.00	8.00	8.00	0.00	0.3	1	false	0	false	false	false	1,432.40	2.0	true	70
5	2U	1355+75.006	1359+98.149	423.14	0.0801	2017: 1,800	12.00	12.00	8.00	8.00	0.00	0.3	1	false	0	false	false	false				
6	2U	1359+98.149	1375+23.561	1,525.41	0.2889	2017: 1,800	12.00	12.00	8.00	8.00	0.00	0.3	1	false	0	false	false	false	2,864.79	2.0	true	70
7	2U	1375+23.561	1393+00.000	1,776.44	0.3365	2017: 1,800	12.00	12.00	8.00	8.00	0.00	0.3	1	false	0	false	false	false				
8	2U	1393+00.000	1401+32.606	832.61	0.1577	2017: 1,800	12.00	12.00	8.00	8.00	3.15	0.3	1	false	0	false	false	false				
9	2U	1401+32.606	1409+13.059	780.45	0.1478	2017: 1,800	12.00	12.00	8.00	8.00	2.40	0.3	1	false	0	false	false	false				
10	2U	1409+13.059	1414+12.992	499.93	0.0947	2017: 1,800	12.00	12.00	8.00	8.00	2.40	0.3	1	false	0	false	false	false	2,050.00	2.0	true	70
11	2U	1414+12.992	1421+34.750	721.76	0.1367	2017: 1,800	12.00	12.00	8.00	8.00	3.50	0.3	1	false	0	false	false	false	2,050.00	2.0	true	70
12	2U	1421+34.750	1429+14.849	780.10	0.1477	2017: 1,800	12.00	12.00	8.00	8.00	3.50	0.3	1	false	0	false	false	false				
13	2U	1429+14.849	1430+94.115	179.27	0.0340	2017: 1,800	12.00	12.00	8.00	8.00	3.50	0.3	1	false	0	false	false	false	2,050.00	2.0	true	70
14	2U	1430+94.115	1439+70.975	876.86	0.1661	2017: 1,800	12.00	12.00	8.00	8.00	3.60	0.3	1	false	0	false	false	false	2,050.00	2.0	true	70
15	2U	1439+70.975	1446+78.905	707.93	0.1341	2017: 1,800	12.00	12.00	8.00	8.00	3.60	0.3	1	false	0	false	false	false				
16	2U	1446+78.905	1474+19.719	2,740.81	0.5191	2017: 1,800	12.00	12.00	8.00	8.00	3.83	0.3	1	false	0	false	false	false				
17	2U	1474+19.719	1482+80.707	860.99	0.1631	2017: 1,800	12.00	12.00	8.00	8.00	3.90	0.3	1	false	0	false	false	false				
18	2U	1482+80.707	1494+92.498	1,211.79	0.2295	2017: 1,800	12.00	12.00	8.00	8.00	3.90	0.3	1	false	0	false	false	false	2,100.00	2.0	true	70
19	2U	1494+92.498	1495+04.975	12.48	0.0024	2017: 1,800	12.00	12.00	8.00	8.00	6.00	0.3	1	false	0	false	false	false	2,100.00	2.0	true	70
20	2U	1495+04.975	1517+91.741	2,286.77	0.4331	2017: 1,800	12.00	12.00	8.00	8.00	6.00	0.3	1	false	0	false	false	false				
21	2U	1517+91.741	1520+69.517	277.78	0.0526	2017: 1,800	12.00	12.00	8.00	8.00	1.80	0.3	1	false	0	false	false	false				
22	2U	1520+69.517	1534+56.073	1,386.56	0.2626	2017: 1,800	12.00	12.00	8.00	8.00	1.80	0.3	1	false	0	false	false	false	2,100.00	2.0	true	70
23	2U	1534+56.073	1537+20.811	264.74	0.0501	2017: 1,800	12.00	12.00	8.00	8.00	0.67	0.3	1	false	0	false	false	false	2,100.00	2.0	true	70
24	2U	1537+20.811	1547+00.000	979.19	0.1855	2017: 1,800	12.00	12.00	8.00	8.00	0.67	0.3	1	false	0	false	false	false				
25	2U	1547+00.000	1547+67.585	67.58	0.0128	2017: 1,800	12.00	12.00	8.00	8.00	0.67	0.3	1	false	1	false	false	false				
26	2U	1547+67.585	1562+96.864	1,529.28	0.2896	2017: 1,800	12.00	12.00	8.00	8.00	0.67	0.3	1	false	1	false	false	false	5,000.00	2.0	true	70
27	2U	1562+96.864	1601+73.850	3,876.99	0.7343	2017: 1,800	12.00	12.00	8.00	8.00	6.00	0.3	1	false	1	false	false	false	5,000.00	2.0	true	70
28	2U	1601+73.850	1602+00.000	26.15	0.0050	2017: 1,800	12.00	12.00	8.00	8.00	6.00	0.3	1	false	1	false	false	false				
29	2U	1602+00.000	1610+00.173	800.17	0.1515	2017: 1,800	12.00	12.00	8.00	8.00	6.00	0.3	1	false	0	false	false	false				
30	2U	1610+00.173	1610+84.612	84.44	0.0160	2017: 1,800	12.00	12.00	8.00	8.00	6.00	0.3	1	false	0	false	false	false	2,500.00	2.0	true	70
31	2U	1610+84.612	1617+23.307	638.70	0.1210	2017: 1,800	12.00	12.00	8.00	8.00	3.35	0.3	1	false	0	false	false	false	2,500.00	2.0	true	70
32	2U	1617+23.307	1627+89.938	1,066.63	0.2020	2017: 1,800	12.00	12.00	8.00	8.00	3.35	0.3	1	false	0	false	false	false				
33	2U	1627+89.938	1643+09.815	1,519.88	0.2879	2017: 1,800	12.00	12.00	8.00	8.00	3.35	0.3	1	false	0	false	false	false	2,546.48	2.0	true	70
34	2U	1643+09.815	1646+52.122	342.31	0.0648	2017: 1,800	12.00	12.00	8.00	8.00	0.54	0.3	1	false	0	false	false	false	2,546.48	2.0	true	70
35	2U	1646+52.122	1655+92.557	940.43	0.1781	2017: 1,800	12.00	12.00	8.00	8.00	0.54	0.3	1	false	0	false	false	false				
36	2U	1655+92.557	1659+03.379	310.82	0.0589	2017: 1,800	12.00	12.00	8.00	8.00	1.28	0.3	1	false	0	false	false	false				
37	2U	1659+03.379	1669+30.626	1,027.25	0.1946	2017: 1,800	12.00	12.00	8.00	8.00	1.28	0.3	1	false	0	false	false	false	2,864.79	2.0	true	70
38	2U	1669+30.626	1674+43.750	513.12	0.0972	2017: 1,800	12.00	12.00	8.00	8.00	1.28	0.3	1	false	0	false	false	false				
39	2U	1674+43.750	1675+11.000	67.25	0.0127	2017: 1,800	12.00	12.00	8.00	8.00	1.28	0.3	1	false	0	false	false	false	2,050.00	2.0	true	70
40	2U	1675+11.000	1677+87.000	276.00	0.0523	2017: 1,800	12.00	12.00	8.00	8.00	1.28	0.3	1	false	1	false	false	false	2,050.00	2.0	true	70

Seg. No.	Type	Start Location	End Location	Length (ft)	Length (mi)	AADT	Left Lane Width (ft)	Right Lane Width (ft)	Left Shoulder Width (ft)	Right Shoulder Width (ft)	Grade (%)	Driveway Density (driveways/mi)	Hazard Rating	Centerline Rumble Strip	Passing Lanes	TWLT Lane	Lighting	Automated Speed Enforcement	Radius (ft)	Superelevation (%)	Adverse	Design Speed (mph)
41	2U	1677+87.000	1681+43.803	356.80	0.0676	2017: 1,800	12.00	12.00	8.00	8.00	1.28	0.3	1	false	2	false	false	false	2,050.00	2.0	true	70
42	2U	1681+43.803	1681+98.703	54.90	0.0104	2017: 1,800	12.00	12.00	8.00	8.00	1.28	0.3	1	false	2	false	false	false				
43	2U	1681+98.703	1690+42.486	843.78	0.1598	2017: 1,800	12.00	12.00	8.00	8.00	0.76	0.3	1	false	2	false	false	false				
44	2U	1690+42.486	1692+18.995	176.51	0.0334	2017: 1,800	12.00	12.00	8.00	8.00	0.76	0.3	1	false	2	false	false	false	2,050.00	2.0	true	70
45	2U	1692+18.995	1696+00.352	381.36	0.0722	2017: 1,800	12.00	12.00	8.00	8.00	2.13	0.3	1	false	2	false	false	false	2,050.00	2.0	true	70
46	2U	1696+00.352	1712+69.818	1,669.47	0.3162	2017: 1,800	12.00	12.00	8.00	8.00	2.13	0.3	1	false	2	false	false	false				
47	2U	1712+69.818	1715+67.336	297.52	0.0563	2017: 1,800	12.00	12.00	8.00	8.00	5.00	0.3	1	false	2	false	false	false				
48	2U	1715+67.336	1721+32.523	565.19	0.1070	2017: 1,800	12.00	12.00	8.00	8.00	5.00	0.3	1	false	2	false	false	false	2,150.00	2.0	true	70
49	2U	1721+32.523	1727+99.101	666.58	0.1263	2017: 1,800	12.00	12.00	8.00	8.00	5.00	0.3	1	false	2	false	false	false				
50	2U	1727+99.101	1732+38.832	439.73	0.0833	2017: 1,800	12.00	12.00	8.00	8.00	5.00	0.3	1	false	2	false	false	false	2,050.00	2.0	true	70
51	2U	1732+38.832	1733+23.295	84.46	0.0160	2017: 1,800	12.00	12.00	8.00	8.00	5.00	0.3	1	false	2	false	false	false				
52	2U	1733+23.295	1751+06.502	1,783.21	0.3377	2017: 1,800	12.00	12.00	8.00	8.00	2.87	0.3	1	false	2	false	false	false				
53	2U	1751+06.502	1769+86.649	1,880.15	0.3561	2017: 1,800	12.00	12.00	8.00	8.00	5.20	0.3	1	false	2	false	false	false				
54	2U	1769+86.649	1773+11.000	324.35	0.0614	2017: 1,800	12.00	12.00	8.00	8.00	0.51	0.3	1	false	2	false	false	false				
55	2U	1773+11.000	1782+08.239	897.24	0.1699	2017: 1,800	12.00	12.00	8.00	8.00	0.51	0.3	1	false	0	false	false	false				
56	2U	1782+08.239	1783+86.769	178.53	0.0338	2017: 1,800	12.00	12.00	8.00	8.00	0.51	0.3	1	false	0	false	false	false	2,100.00	2.0	true	70
57	2U	1783+86.769	1785+60.207	173.44	0.0328	2017: 1,800	12.00	12.00	8.00	8.00	0.51	0.3	1	false	0	false	false	false				
58	2U	1785+60.207	1797+04.916	1,144.71	0.2168	2017: 1,800	12.00	12.00	8.00	8.00	4.00	0.3	1	false	0	false	false	false				
59	2U	1797+04.916	1805+56.375	851.46	0.1613	2017: 1,800	12.00	12.00	8.00	8.00	4.00	0.3	1	false	0	false	false	false	2,100.00	2.0	true	70
60	2U	1805+56.375	1836+97.715	3,141.34	0.5949	2017: 1,800	12.00	12.00	8.00	8.00	4.00	0.3	1	false	0	false	false	false				
61	2U	1836+97.715	1848+67.739	1,170.02	0.2216	2017: 1,800	12.00	12.00	8.00	8.00	4.00	0.3	1	false	0	false	false	false	2,050.00	2.0	true	70
62	2U	1848+67.739	1851+41.349	273.61	0.0518	2017: 1,800	12.00	12.00	8.00	8.00	4.00	0.3	1	false	0	false	false	false				
63	2U	1851+41.349	1857+54.083	612.73	0.1161	2017: 1,800	12.00	12.00	8.00	8.00	4.00	0.3	1	false	0	false	false	false	2,050.00	2.0	true	70
64	2U	1857+54.083	1880+88.000	2,333.92	0.4420	2017: 1,800	12.00	12.00	8.00	8.00	4.00	0.3	1	false	0	false	false	false				
65	2U	1880+88.000	1883+68.000	280.00	0.0530	2017: 1,800	12.00	12.00	8.00	8.00	4.00	0.3	1	false	1	false	false	false				
66	2U	1883+68.000	1884+55.041	87.04	0.0165	2017: 1,800	12.00	12.00	8.00	8.00	4.00	0.3	1	false	2	false	false	false				
67	2U	1884+55.041	1890+37.663	582.62	0.1104	2017: 1,800	12.00	12.00	8.00	8.00	4.00	0.3	1	false	2	false	false	false	2,050.00	2.0	true	70
68	2U	1890+37.663	1894+28.643	390.98	0.0741	2017: 1,800	12.00	12.00	8.00	8.00	4.00	0.3	1	false	2	false	false	false				
69	2U	1894+28.643	1905+57.352	1,128.71	0.2138	2017: 1,800	12.00	12.00	8.00	8.00	4.00	0.3	1	false	2	false	false	false	2,050.00	2.0	true	70
70	2U	1905+57.352	1905+75.567	18.21	0.0034	2017: 1,800	12.00	12.00	8.00	8.00	4.00	0.3	1	false	2	false	false	false				
71	2U	1905+75.567	1929+09.242	2,333.68	0.4420	2017: 1,800	12.00	12.00	8.00	8.00	1.31	0.3	1	false	2	false	false	false				
72	2U	1929+09.242	1935+82.969	673.73	0.1276	2017: 1,800	12.00	12.00	8.00	8.00	4.11	0.3	1	false	2	false	false	false				
73	2U	1935+82.969	1972+62.568	3,679.60	0.6969	2017: 1,800	12.00	12.00	8.00	8.00	1.20	0.3	1	false	2	false	false	false				
74	2U	1972+62.568	1984+13.000	1,150.43	0.2179	2017: 1,800	12.00	12.00	8.00	8.00	5.00	0.3	1	false	2	false	false	false				
75	2U	1984+13.000	1997+37.976	1,324.98	0.2509	2017: 1,800	12.00	12.00	8.00	8.00	5.00	0.3	1	false	0	false	false	false				
76	2U	1997+37.976	2027+35.720	2,997.74	0.5677	2017: 1,800	12.00	12.00	8.00	8.00	5.00	0.3	1	false	0	false	false	false				
77	2U	2027+35.720	2043+47.648	1,611.93	0.3053	2017: 1,800	12.00	12.00	8.00	8.00	0.34	0.3	1	false	0	false	false	false				
78	2U	2043+47.648	2053+08.501	960.85	0.1820	2017: 1,800	12.00	12.00	8.00	8.00	0.86	0.3	1	false	0	false	false	false				
79	2U	2053+08.501	2067+63.430	1,454.93	0.2756	2017: 1,800	12.00	12.00	8.00	8.00	0.86	0.3	1	false	0	false	false	false	5,729.58	2.0	true	70
80	2U	2067+63.430	2068+50.198	86.77	0.0164	2017: 1,800	12.00	12.00	8.00	8.00	2.07	0.3	1	false	0	false	false	false	5,729.58	2.0	true	70
81	2U	2068+50.198	2082+15.567	1,365.37	0.2586	2017: 1,800	12.00	12.00	8.00	8.00	2.07	0.3	1	false	0	false	false	false				
82	2U	2082+15.567	2094+20.956	1,205.39	0.2283	2017: 1,800	12.00	12.00	8.00	8.00	1.49	0.3	1	false	0	false	false	false				
83	2U	2094+20.956	2104+07.717	986.76	0.1869	2017: 1,800	12.00	12.00	8.00	8.00	0.07	0.3	1	false	0	false	false	false				

Seg. No.	Type	Start Location	End Location	Length (ft)	Length (mi)	AADT	Left Lane Width (ft)	Right Lane Width (ft)	Left Shoulder Width (ft)	Right Shoulder Width (ft)	Grade (%)	Driveway Density (driveways/mi)	Hazard Rating	Centerline Rumble Strip	Passing Lanes	TWLT Lane	Lighting	Automated Speed Enforcement	Radius (ft)	Superelevation (%)	Adverse	Design Speed (mph)
84	2U	2104+07.717	2112+43.653	835.94	0.1583	2017: 1,800	12.00	12.00	8.00	8.00	2.15	0.3	1	false	0	false	false	false				
85	2U	2112+43.653	2120+00.000	756.35	0.1432	2017: 1,800	12.00	12.00	8.00	8.00	0.59	0.3	1	false	0	false	false	false				
86	2U	2120+00.000	2122+66.738	266.74	0.0505	2017: 1,800	12.00	12.00	8.00	8.00	0.59	0.3	1	false	2	false	false	false				
87	2U	2122+66.738	2124+42.138	175.40	0.0332	2017: 1,800	12.00	12.00	8.00	8.00	0.59	0.3	1	false	2	false	false	false	5,729.58	2.0	true	70
88	2U	2124+42.138	2150+23.032	2,580.89	0.4888	2017: 1,800	12.00	12.00	8.00	8.00	2.00	0.3	1	false	2	false	false	false	5,729.58	2.0	true	70
89	2U	2150+23.032	2165+24.800	1,501.77	0.2844	2017: 1,800	12.00	12.00	8.00	8.00	2.30	0.3	1	false	2	false	false	false	5,729.58	2.0	true	70
90	2U	2165+24.800	2165+36.208	11.41	0.0022	2017: 1,800	12.00	12.00	8.00	8.00	3.50	0.3	1	false	2	false	false	false	5,729.58	2.0	true	70
91	2U	2165+36.208	2180+36.257	1,500.05	0.2841	2017: 1,800	12.00	12.00	8.00	8.00	3.50	0.3	1	false	2	false	false	false				
92	2U	2180+36.257	2183+23.204	286.95	0.0544	2017: 1,800	12.00	12.00	8.00	8.00	1.95	0.3	1	false	2	false	false	false				
93	2U	2183+23.204	2192+57.094	933.89	0.1769	2017: 1,800	12.00	12.00	8.00	8.00	1.95	0.3	1	false	2	false	false	false	2,864.79	2.0	true	70
94	2U	2192+57.094	2200+00.000	742.91	0.1407	2017: 1,800	12.00	12.00	8.00	8.00	1.95	0.3	1	false	2	false	false	false				
95	2U	2200+00.000	2206+08.668	608.67	0.1153	2017: 1,800	12.00	12.00	8.00	8.00	1.95	0.3	1	false	0	false	false	false				
96	2U	2206+08.668	2219+36.220	1,327.55	0.2514	2017: 1,800	12.00	12.00	8.00	8.00	0.92	0.3	1	false	0	false	false	false				
97	2U	2219+36.220	2234+49.053	1,512.83	0.2865	2017: 1,800	12.00	12.00	8.00	8.00	2.11	0.3	1	false	0	false	false	false				
98	2U	2234+49.053	2235+79.281	130.23	0.0247	2017: 1,800	12.00	12.00	8.00	8.00	2.11	0.3	1	false	0	false	false	false	2,788.71	2.0	true	70
99	2U	2235+79.281	2249+78.454	1,399.17	0.2650	2017: 1,800	12.00	12.00	8.00	8.00	1.57	0.3	1	false	0	false	false	false	2,788.71	2.0	true	70
100	2U	2249+78.454	2253+09.642	331.19	0.0627	2017: 1,800	12.00	12.00	8.00	8.00	1.57	0.3	1	false	0	false	false	false				
101	2U	2253+09.642	2257+27.920	418.28	0.0792	2017: 1,800	12.00	12.00	8.00	8.00	3.52	0.3	1	false	0	false	false	false				
102	2U	2257+27.920	2265+11.600	783.68	0.1484	2017: 1,800	12.00	12.00	8.00	8.00	3.52	0.3	1	false	0	false	false	false	2,788.71	2.0	true	70
103	2U	2265+11.600	2279+96.243	1,484.64	0.2812	2017: 1,800	12.00	12.00	8.00	8.00	0.10	0.3	1	false	0	false	false	false	2,788.71	2.0	true	70
104	2U	2279+96.243	2306+57.050	2,660.81	0.5039	2017: 1,800	12.00	12.00	8.00	8.00	0.10	0.3	1	false	0	false	false	false				
105	2U	2306+57.050	2318+07.600	1,150.55	0.2179	2017: 1,800	12.00	12.00	8.00	8.00	0.10	0.3	1	false	0	false	false	false	2,864.09	2.0	true	70
106	2U	2318+07.600	2369+89.689	5,182.09	0.9815	2017: 1,800	12.00	12.00	8.00	8.00	0.10	0.3	1	false	0	false	false	false				
107	2U	2369+89.689	2375+07.219	517.53	0.0980	2017: 1,800	12.00	12.00	8.00	8.00	0.10	0.3	1	false	0	false	false	false	2,050.00	2.0	true	70
108	2U	2375+07.219	2376+29.630	122.41	0.0232	2017: 1,800	12.00	12.00	8.00	8.00	1.76	0.3	1	false	0	false	false	false	2,050.00	2.0	true	70
109	2U	2376+29.630	2381+18.255	488.63	0.0925	2017: 1,800	12.00	12.00	8.00	8.00	1.76	0.3	1	false	0	false	false	false				
110	2U	2381+18.255	2386+93.841	575.59	0.1090	2017: 1,800	12.00	12.00	8.00	8.00	1.76	0.3	1	false	0	false	false	false	1,145.92	2.0	true	70
111	2U	2386+93.841	2392+65.999	572.16	0.1084	2017: 1,800	12.00	12.00	8.00	8.00	0.18	0.3	1	false	0	false	false	false	1,145.92	2.0	true	70
112	2U	2392+65.999	2395+41.312	275.31	0.0521	2017: 1,800	12.00	12.00	8.00	8.00	0.18	0.3	1	false	0	false	false	false				
113	2U	2395+41.312	2397+77.506	236.19	0.0447	2017: 1,800	12.00	12.00	8.00	8.00	0.87	0.3	1	false	0	false	false	false				
114	2U	2397+77.506	2398+49.016	71.51	0.0135	2017: 1,800	12.00	12.00	8.00	8.00	0.87	0.3	1	false	0	false	false	false	1,145.91	2.0	true	70
115	2U	2398+49.016	2401+00.003	250.99	0.0475	2017: 1,800	12.00	12.00	8.00	8.00	0.32	0.3	1	false	0	false	false	false	1,145.91	2.0	true	70
116	2U	2401+00.003	2408+51.850	751.85	0.1424	2017: 1,800	12.00	12.00	8.00	8.00	0.00	0.3	1	false	0	false	false	false	1,145.91	2.0	true	70
117	2U	2408+51.850	2441+82.284	3,330.43	0.6308	2017: 1,800	12.00	12.00	8.00	8.00	0.00	0.3	1	false	0	false	false	false				
118	2U	2441+82.284	2448+88.292	706.01	0.1337	2017: 1,800	12.00	12.00	8.00	8.00	0.00	0.3	1	false	0	false	false	false	1,912.94	2.0	true	70
119	2U	2448+88.292	2469+47.035	2,058.74	0.3899	2017: 1,800	12.00	12.00	8.00	8.00	0.00	0.3	1	false	0	false	false	false				



**Table 3. Crash History Highway - Homogeneous Segments (Section 1)**

Seg. No.	Type	Start Location	End Location	Length (ft)	Length (mi)	AADT	Left Lane Width (ft)	Right Lane Width (ft)	Left Shoulder Width (ft)	Right Shoulder Width (ft)	Grade (%)	Driveway Density (driveways/mi)	Hazard Rating	Centerline Rumble Strip	Passing Lanes	TW LT Lane	Lighting	Automated Speed Enforcement	Radius (ft)	Superelevation (%)	Adverse	Design Speed (mph)
1	2U	1327+09.00	1336+44.302	935.30	0.1771	2010-2014: 1,800	12.00	12.00	8.00	8.00	0.00	0.3	1	false	0	false	false	false				
2	2U	1336+44.302	1341+64.474	520.17	0.0985	2010-2014: 1,800	12.00	12.00	8.00	8.00	0.00	0.3	1	false	0	false	false	false	2,864.79	2.0	true	60
3	2U	1341+64.474	1345+88.891	424.42	0.0804	2010-2014: 1,800	12.00	12.00	8.00	8.00	6.00	0.3	1	false	0	false	false	false	2,864.79	2.0	true	60
4	2U	1345+88.891	1349+42.437	353.55	0.0670	2010-2014: 1,800	12.00	12.00	8.00	8.00	6.00	0.3	1	false	0	false	false	false				
5	2U	1349+42.437	1350+43.605	101.17	0.0192	2010-2014: 1,800	12.00	12.00	8.00	8.00	0.00	0.3	1	false	0	false	false	false				
6	2U	1350+43.605	1355+75.006	531.40	0.1006	2010-2014: 1,800	12.00	12.00	8.00	8.00	0.00	0.3	1	false	0	false	false	false	1,432.40	2.0	true	60
7	2U	1355+75.006	1359+98.149	423.14	0.0801	2010-2014: 1,800	12.00	12.00	8.00	8.00	0.00	0.3	1	false	0	false	false	false				
8	2U	1359+98.149	1361+84.449	186.30	0.0353	2010-2014: 1,800	12.00	12.00	8.00	8.00	0.00	0.3	1	false	0	false	false	false	2,864.79	2.0	true	60
9	2U	1361+84.449	1372+13.914	1,029.46	0.1950	2010-2014: 1,800	12.00	12.00	8.00	8.00	2.77	0.3	1	false	0	false	false	false	2,864.79	2.0	true	60
10	2U	1372+13.914	1375+23.561	309.65	0.0587	2010-2014: 1,800	12.00	12.00	8.00	8.00	3.10	0.3	1	false	0	false	false	false	2,864.79	2.0	true	60
11	2U	1375+23.561	1403+14.142	2,790.58	0.5285	2010-2014: 1,800	12.00	12.00	8.00	8.00	3.10	0.3	1	false	0	false	false	false				
12	2U	1403+14.142	1409+56.099	641.96	0.1216	2010-2014: 1,800	12.00	12.00	8.00	8.00	4.20	0.3	1	false	0	false	false	false				
13	2U	1409+56.099	1413+11.581	355.48	0.0673	2010-2014: 1,800	12.00	12.00	8.00	8.00	4.20	0.3	1	false	0	false	false	false	1,909.86	2.0	true	60
14	2U	1413+11.581	1420+94.274	782.69	0.1482	2010-2014: 1,800	12.00	12.00	8.00	8.00	4.57	0.3	1	false	0	false	false	false	1,909.86	2.0	true	60
15	2U	1420+94.274	1425+01.019	406.75	0.0770	2010-2014: 1,800	12.00	12.00	8.00	8.00	4.57	0.3	1	false	0	false	false	false				
16	2U	1425+01.019	1429+54.331	453.31	0.0858	2010-2014: 1,800	12.00	12.00	8.00	8.00	0.50	0.3	1	false	0	false	false	false				
17	2U	1429+54.331	1434+88.047	533.72	0.1011	2010-2014: 1,800	12.00	12.00	8.00	8.00	0.50	0.3	1	false	0	false	false	false	1,909.86	2.0	true	60
18	2U	1434+88.047	1439+38.259	450.21	0.0853	2010-2014: 1,800	12.00	12.00	8.00	8.00	3.40	0.3	1	false	0	false	false	false	1,909.86	2.0	true	60
19	2U	1439+38.259	1442+00.000	261.74	0.0496	2010-2014: 1,800	12.00	12.00	8.00	8.00	3.40	0.3	1	false	0	false	false	false				
20	2U	1442+00.000	1445+85.729	385.73	0.0731	2010-2014: 1,800	12.00	12.00	8.00	8.00	3.40	0.3	1	false	1	false	false	false				
21	2U	1445+85.729	1454+00.000	814.27	0.1542	2010-2014: 1,800	12.00	12.00	8.00	8.00	3.50	0.3	1	false	1	false	false	false				
22	2U	1454+00.000	1457+87.869	387.87	0.0735	2010-2014: 1,800	12.00	12.00	8.00	8.00	3.50	0.3	1	false	0	false	false	false				
23	2U	1457+87.869	1463+32.941	545.07	0.1032	2010-2014: 1,800	12.00	12.00	8.00	8.00	3.50	0.3	1	false	0	false	false	false	2,864.79	2.0	true	60
24	2U	1463+32.941	1468+59.089	526.15	0.0997	2010-2014: 1,800	12.00	12.00	8.00	8.00	3.50	0.3	1	false	0	false	false	false				
25	2U	1468+59.089	1473+71.093	512.00	0.0970	2010-2014: 1,800	12.00	12.00	8.00	8.00	3.50	0.3	1	false	0	false	false	false	1,950.00	2.0	true	60
26	2U	1473+71.093	1477+61.956	390.86	0.0740	2010-2014: 1,800	12.00	12.00	8.00	8.00	0.30	0.3	1	false	0	false	false	false	1,950.00	2.0	true	60
27	2U	1477+61.956	1482+39.570	477.61	0.0905	2010-2014: 1,800	12.00	12.00	8.00	8.00	0.30	0.3	1	false	0	false	false	false				
28	2U	1482+39.570	1490+31.091	791.52	0.1499	2010-2014: 1,800	12.00	12.00	8.00	8.00	0.60	0.3	1	false	0	false	false	false				
29	2U	1490+31.091	1502+99.266	1,268.17	0.2402	2010-2014: 1,800	12.00	12.00	8.00	8.00	0.60	0.3	1	false	0	false	false	false	1,155.00	2.0	true	60
30	2U	1502+99.266	1506+85.128	385.86	0.0731	2010-2014: 1,800	12.00	12.00	8.00	8.00	4.20	0.3	1	false	0	false	false	false	1,155.00	2.0	true	60
31	2U	1506+85.128	1511+36.056	450.93	0.0854	2010-2014: 1,800	12.00	12.00	8.00	8.00	4.20	0.3	1	false	0	false	false	false				
32	2U	1511+36.056	1518+02.293	666.24	0.1262	2010-2014: 1,800	12.00	12.00	8.00	8.00	4.20	0.3	1	false	0	false	false	false	1,145.92	2.0	true	60
33	2U	1518+02.293	1522+56.443	454.15	0.0860	2010-2014: 1,800	12.00	12.00	8.00	8.00	4.20	0.3	1	false	0	false	false	false				
34	2U	1522+56.443	1530+56.765	800.32	0.1516	2010-2014: 1,800	12.00	12.00	8.00	8.00	2.40	0.3	1	false	0	false	false	false				
35	2U	1530+56.765	1532+29.037	172.27	0.0326	2010-2014: 1,800	12.00	12.00	8.00	8.00	2.40	0.3	1	false	0	false	false	false	1,440.00	2.0	true	60

Seg. No.	Type	Start Location	End Location	Length (ft)	Length (mi)	AADT	Left Lane Width (ft)	Right Lane Width (ft)	Left Shoulder Width (ft)	Right Shoulder Width (ft)	Grade (%)	Driveway Density (driveways/mi)	Hazard Rating	Centerline Rumble Strip	Passing Lanes	TW LT Lane	Lighting	Automated Speed Enforcement	Radius (ft)	Superelevation (%)	Adverse	Design Speed (mph)
36	2U	1532+29.037	1546+35.066	1,406.03	0.2663	2010-2014: 1,800	12.00	12.00	8.00	8.00	1.55	0.3	1	false	0	false	false	false	1,440.0	2.0	true	60
37	2U	1546+35.066	1555+00.000	864.93	0.1638	2010-2014: 1,800	12.00	12.00	8.00	8.00	1.55	0.3	1	false	0	false	false	false				
38	2U	1555+00.000	1555+42.935	42.94	0.0081	2010-2014: 1,800	12.00	12.00	8.00	8.00	1.55	0.3	1	false	1	false	false	false				
39	2U	1555+42.935	1561+65.077	622.14	0.1178	2010-2014: 1,800	12.00	12.00	8.00	8.00	2.00	0.3	1	false	1	false	false	false				
40	2U	1561+65.077	1568+88.080	723.00	0.1369	2010-2014: 1,800	12.00	12.00	8.00	8.00	2.00	0.3	1	false	1	false	false	false	1,152.00	2.0	true	60
41	2U	1568+88.080	1575+49.666	661.59	0.1253	2010-2014: 1,800	12.00	12.00	8.00	8.00	7.00	0.3	1	false	1	false	false	false	1,152.00	2.0	true	60
42	2U	1575+49.666	1579+81.473	431.81	0.0818	2010-2014: 1,800	12.00	12.00	8.00	8.00	7.00	0.3	1	false	1	false	false	false				
43	2U	1579+81.473	1587+62.614	781.14	0.1479	2010-2014: 1,800	12.00	12.00	8.00	8.00	7.00	0.3	1	false	1	false	false	false	881.47	2.0	true	60
44	2U	1587+62.614	1589+20.405	157.79	0.0299	2010-2014: 1,800	12.00	12.00	8.00	8.00	7.00	0.3	1	false	1	false	false	false				
45	2U	1589+20.405	1591+85.378	264.97	0.0502	2010-2014: 1,800	12.00	12.00	8.00	8.00	3.90	0.3	1	false	1	false	false	false				
46	2U	1591+85.378	1598+89.259	703.88	0.1333	2010-2014: 1,800	12.00	12.00	8.00	8.00	3.90	0.3	1	false	1	false	false	false	825.00	2.0	true	60
47	2U	1598+89.259	1604+98.065	608.81	0.1153	2010-2014: 1,800	12.00	12.00	8.00	8.00	7.00	0.3	1	false	1	false	false	false	825.00	2.0	true	60
48	2U	1604+98.065	1609+35.192	437.13	0.0828	2010-2014: 1,800	12.00	12.00	8.00	8.00	7.00	0.3	1	false	1	false	false	false				
49	2U	1609+35.192	1610+00.000	64.81	0.0123	2010-2014: 1,800	12.00	12.00	8.00	8.00	7.00	0.3	1	false	1	false	false	false	1,041.74	2.0	true	60
50	2U	1610+00.000	1614+65.403	465.40	0.0881	2010-2014: 1,800	12.00	12.00	8.00	8.00	7.00	0.3	1	false	0	false	false	false	1,041.74	2.0	true	60
51	2U	1614+65.403	1615+65.837	100.43	0.0190	2010-2014: 1,800	12.00	12.00	8.00	8.00	7.00	0.3	1	false	0	false	false	false				
52	2U	1615+65.837	1623+55.342	789.50	0.1495	2010-2014: 1,800	12.00	12.00	8.00	8.00	0.70	0.3	1	false	0	false	false	false				
53	2U	1623+55.342	1627+06.536	351.19	0.0665	2010-2014: 1,800	12.00	12.00	8.00	8.00	0.70	0.3	1	false	0	false	false	false	3,819.72	2.0	true	60
54	2U	1627+06.536	1634+67.324	760.79	0.1441	2010-2014: 1,800	12.00	12.00	8.00	8.00	3.30	0.3	1	false	0	false	false	false	3,819.72	2.0	true	60
55	2U	1634+67.324	1643+43.433	876.11	0.1659	2010-2014: 1,800	12.00	12.00	8.00	8.00	3.30	0.3	1	false	0	false	false	false				
56	2U	1643+43.433	1658+40.396	1,496.96	0.2835	2010-2014: 1,800	12.00	12.00	8.00	8.00	3.30	0.3	1	false	0	false	false	false	2,546.48	2.0	true	60
57	2U	1658+40.396	1662+05.617	365.22	0.0692	2010-2014: 1,800	12.00	12.00	8.00	8.00	0.70	0.3	1	false	0	false	false	false	2,546.48	2.0	true	60
58	2U	1662+05.617	1671+65.038	959.42	0.1817	2010-2014: 1,800	12.00	12.00	8.00	8.00	0.70	0.3	1	false	0	false	false	false				
59	2U	1671+65.038	1674+56.874	291.84	0.0553	2010-2014: 1,800	12.00	12.00	8.00	8.00	1.30	0.3	1	false	0	false	false	false				
60	2U	1674+56.874	1681+00.000	643.13	0.1218	2010-2014: 1,800	12.00	12.00	8.00	8.00	1.30	0.3	1	false	0	false	false	false	2,864.79	2.0	true	60
61	2U	1681+00.000	1684+84.121	384.12	0.0727	2010-2014: 1,800	12.00	12.00	8.00	8.00	1.30	0.3	1	false	1	false	false	false	2,864.79	2.0	true	60

Seg. No.	Type	Start Location	End Location	Length (ft)	Length (mi)	AADT	Left Lane Width (ft)	Right Lane Width (ft)	Left Shoulder Width (ft)	Right Shoulder Width (ft)	Grade (%)	Driveway Density (driveways/mi)	Hazard Rating	Centerline Rumble Strip	Passing Lanes	TW LT Lane	Lighting	Automated Speed Enforcement	Radius (ft)	Superelevation (%)	Adverse	Design Speed (mph)
62	2U	1684+84.1 21	1689+55.5 48	471.43	0.089 3	2010-2014: 1,800	12.0 0	12.0 0	8.00	8.00	1.30	0.3	1	false	1	false	false	false				
63	2U	1689+55.5 48	1696+91.2 31	735.68	0.139 3	2010-2014: 1,800	12.0 0	12.0 0	8.00	8.00	1.30	0.3	1	false	1	false	false	false	2,291.8 3	2.0	true	60
64	2U	1696+91.2 31	1697+38.1 84	46.95	0.008 9	2010-2014: 1,800	12.0 0	12.0 0	8.00	8.00	0.60	0.3	1	false	1	false	false	false	2,291.8 3	2.0	true	60
65	2U	1697+38.1 84	1703+52.8 75	614.69	0.116 4	2010-2014: 1,800	12.0 0	12.0 0	8.00	8.00	0.60	0.3	1	false	1	false	false	false				
66	2U	1703+52.8 75	1708+54.6 49	501.77	0.095 0	2010-2014: 1,800	12.0 0	12.0 0	8.00	8.00	0.60	0.3	1	false	1	false	false	false	3,819.7 2	2.0	true	60
67	2U	1708+54.6 49	1713+92.3 35	537.69	0.101 8	2010-2014: 1,800	12.0 0	12.0 0	8.00	8.00	4.00	0.3	1	false	1	false	false	false	3,819.7 2	2.0	true	60
68	2U	1713+92.3 35	1716+89.4 63	297.13	0.056 3	2010-2014: 1,800	12.0 0	12.0 0	8.00	8.00	4.00	0.3	1	false	1	false	false	false				
69	2U	1716+89.4 63	1728+08.3 81	1,118.9 2	0.211 9	2010-2014: 1,800	12.0 0	12.0 0	8.00	8.00	0.50	0.3	1	false	1	false	false	false				
70	2U	1728+08.3 81	1731+17.0 25	308.64	0.058 5	2010-2014: 1,800	12.0 0	12.0 0	8.00	8.00	5.30	0.3	1	false	1	false	false	false				
71	2U	1731+17.0 25	1736+82.2 12	565.19	0.107 0	2010-2014: 1,800	12.0 0	12.0 0	8.00	8.00	5.30	0.3	1	false	1	false	false	false	2,150.0 0	2.0	true	60
72	2U	1736+82.2 12	1739+00.0 00	217.79	0.041 3	2010-2014: 1,800	12.0 0	12.0 0	8.00	8.00	5.30	0.3	1	false	1	false	false	false				
73	2U	1739+00.0 00	1749+79.7 05	1,079.7 0	0.204 5	2010-2014: 1,800	12.0 0	12.0 0	8.00	8.00	5.30	0.3	1	false	0	false	false	false				
74	2U	1749+79.7 05	1750+54.6 78	74.97	0.014 2	2010-2014: 1,800	12.0 0	12.0 0	8.00	8.00	5.30	0.3	1	false	0	false	false	false	1,950.0 0	2.0	true	60
75	2U	1750+54.6 78	1754+00.0 00	345.32	0.065 4	2010-2014: 1,800	12.0 0	12.0 0	8.00	8.00	4.60	0.3	1	false	0	false	false	false	1,950.0 0	2.0	true	60
76	2U	1754+00.0 00	1756+47.3 61	247.36	0.046 9	2010-2014: 1,800	12.0 0	12.0 0	8.00	8.00	4.60	0.3	1	false	1	false	false	false	1,950.0 0	2.0	true	60
77	2U	1756+47.3 61	1761+94.1 71	546.81	0.103 6	2010-2014: 1,800	12.0 0	12.0 0	8.00	8.00	4.60	0.3	1	false	1	false	false	false				
78	2U	1761+94.1 71	1764+68.4 38	274.27	0.051 9	2010-2014: 1,800	12.0 0	12.0 0	8.00	8.00	4.60	0.3	1	false	1	false	false	false	5,800.0 0	2.0	true	60
79	2U	1764+68.4 38	1769+37.9 86	469.55	0.088 9	2010-2014: 1,800	12.0 0	12.0 0	8.00	8.00	5.00	0.3	1	false	1	false	false	false	5,800.0 0	2.0	true	60
80	2U	1769+37.9 86	1786+03.0 32	1,665.0 5	0.315 4	2010-2014: 1,800	12.0 0	12.0 0	8.00	8.00	5.00	0.3	1	false	1	false	false	false				
81	2U	1786+03.0 32	1796+26.4 15	1,023.3 8	0.193 8	2010-2014: 1,800	12.0 0	12.0 0	8.00	8.00	0.30	0.3	1	false	1	false	false	false				
82	2U	1796+26.4 15	1801+11.4 57	485.04	0.091 9	2010-2014: 1,800	12.0 0	12.0 0	8.00	8.00	0.30	0.3	1	false	1	false	false	false	5,729.5 8	2.0	true	60
83	2U	1801+11.4 57	1803+66.3 90	254.93	0.048 3	2010-2014: 1,800	12.0 0	12.0 0	8.00	8.00	0.30	0.3	1	false	1	false	false	false				
84	2U	1803+66.3 90	1814+09.5 17	1,043.1 3	0.197 6	2010-2014: 1,800	12.0 0	12.0 0	8.00	8.00	4.90	0.3	1	false	1	false	false	false				
85	2U	1814+09.5 17	1819+97.4 64	587.95	0.111 4	2010-2014: 1,800	12.0 0	12.0 0	8.00	8.00	4.90	0.3	1	false	1	false	false	false	1,450.0 0	2.0	true	60
86	2U	1819+97.4 64	1820+48.0 62	50.60	0.009 6	2010-2014: 1,800	12.0 0	12.0 0	8.00	8.00	4.90	0.3	1	false	1	false	false	false				
87	2U	1820+48.0 62	1824+53.8 98	405.84	0.076 9	2010-2014: 1,800	12.0 0	12.0 0	8.00	8.00	1.70	0.3	1	false	1	false	false	false				

Seg. No.	Type	Start Location	End Location	Length (ft)	Length (mi)	AADT	Left Lane Width (ft)	Right Lane Width (ft)	Left Shoulder Width (ft)	Right Shoulder Width (ft)	Grade (%)	Driveway Density (driveways/mi)	Hazard Rating	Centerline Rumble Strip	Passing Lanes	TW LT Lane	Lighting	Automated Speed Enforcement	Radius (ft)	Superelevation (%)	Adverse	Design Speed (mph)
88	2U	1824+53.898	1826+89.465	235.57	0.0446	2010-2014: 1,800	12.00	12.00	8.00	8.00	1.70	0.3	1	false	1	false	false	false	3,000.00	2.0	true	60
89	2U	1826+89.465	1830+41.880	352.42	0.0668	2010-2014: 1,800	12.00	12.00	8.00	8.00	5.00	0.3	1	false	1	false	false	false	3,000.00	2.0	true	60
90	2U	1830+41.880	1836+58.064	616.18	0.1167	2010-2014: 1,800	12.00	12.00	8.00	8.00	5.00	0.3	1	false	1	false	false	false				
91	2U	1836+58.064	1841+90.386	532.32	0.1008	2010-2014: 1,800	12.00	12.00	8.00	8.00	5.00	0.3	1	false	1	false	false	false	1,160.00	2.0	true	60
92	2U	1841+90.386	1844+74.496	284.11	0.0538	2010-2014: 1,800	12.00	12.00	8.00	8.00	4.00	0.3	1	false	1	false	false	false	1,160.00	2.0	true	60
93	2U	1844+74.496	1849+15.104	440.61	0.0834	2010-2014: 1,800	12.00	12.00	8.00	8.00	4.00	0.3	1	false	1	false	false	false				
94	2U	1849+15.104	1858+04.945	889.84	0.1685	2010-2014: 1,800	12.00	12.00	8.00	8.00	4.00	0.3	1	false	1	false	false	false	825.00	2.0	true	60
95	2U	1858+04.945	1869+49.895	1,144.95	0.2168	2010-2014: 1,800	12.00	12.00	8.00	8.00	4.00	0.3	1	false	1	false	false	false				
96	2U	1869+49.895	1875+20.742	570.85	0.1081	2010-2014: 1,800	12.00	12.00	8.00	8.00	4.00	0.3	1	false	1	false	false	false	1,909.86	2.0	true	60
97	2U	1875+20.742	1887+50.279	1,229.54	0.2329	2010-2014: 1,800	12.00	12.00	8.00	8.00	4.00	0.3	1	false	1	false	false	false				
98	2U	1887+50.279	1899+00.000	1,149.72	0.2177	2010-2014: 1,800	12.00	12.00	8.00	8.00	3.20	0.3	1	false	1	false	false	false				
99	2U	1899+00.000	1902+52.815	352.81	0.0668	2010-2014: 1,800	12.00	12.00	8.00	8.00	3.20	0.3	1	false	0	false	false	false				
100	2U	1902+52.815	1908+15.543	562.73	0.1066	2010-2014: 1,800	12.00	12.00	8.00	8.00	3.20	0.3	1	false	0	false	false	false	1,980.00	2.0	true	60
101	2U	1908+15.543	1912+56.122	440.58	0.0834	2010-2014: 1,800	12.00	12.00	8.00	8.00	3.20	0.3	1	false	0	false	false	false				
102	2U	1912+56.122	1922+09.301	953.18	0.1805	2010-2014: 1,800	12.00	12.00	8.00	8.00	3.20	0.3	1	false	0	false	false	false	1,909.86	2.0	true	60
103	2U	1922+09.301	1923+07.672	98.37	0.0186	2010-2014: 1,800	12.00	12.00	8.00	8.00	0.16	0.3	1	false	0	false	false	false	1,909.86	2.0	true	60
104	2U	1923+07.672	1942+90.110	1,982.44	0.3755	2010-2014: 1,800	12.00	12.00	8.00	8.00	0.16	0.3	1	false	0	false	false	false				
105	2U	1942+90.110	1951+68.332	878.22	0.1663	2010-2014: 1,800	12.00	12.00	8.00	8.00	4.20	0.3	1	false	0	false	false	false				
106	2U	1951+68.332	1991+05.968	3,937.64	0.7458	2010-2014: 1,800	12.00	12.00	8.00	8.00	1.30	0.3	1	false	0	false	false	false				
107	2U	1991+05.968	2014+85.473	2,379.51	0.4507	2010-2014: 1,800	12.00	12.00	8.00	8.00	5.00	0.3	1	false	0	false	false	false				
108	2U	2014+85.473	2044+63.612	2,978.14	0.5640	2010-2014: 1,800	12.00	12.00	8.00	8.00	5.00	0.3	1	false	0	false	false	false				
109	2U	2044+63.612	2061+78.629	1,715.02	0.3248	2010-2014: 1,800	12.00	12.00	8.00	8.00	0.30	0.3	1	false	0	false	false	false				
110	2U	2061+78.629	2070+98.406	919.78	0.1742	2010-2014: 1,800	12.00	12.00	8.00	8.00	0.80	0.3	1	false	0	false	false	false				
111	2U	2070+98.406	2084+39.972	1,341.57	0.2541	2010-2014: 1,800	12.00	12.00	8.00	8.00	0.80	0.3	1	false	0	false	false	false	5,729.58	2.0	true	60
112	2U	2084+39.972	2086+40.102	200.13	0.0379	2010-2014: 1,800	12.00	12.00	8.00	8.00	2.00	0.3	1	false	0	false	false	false	5,729.58	2.0	true	60
113	2U	2086+40.102	2099+74.790	1,334.69	0.2528	2010-2014: 1,800	12.00	12.00	8.00	8.00	2.00	0.3	1	false	0	false	false	false				

Seg. No.	Type	Start Location	End Location	Length (ft)	Length (mi)	AADT	Left Lane Width (ft)	Right Lane Width (ft)	Left Shoulder Width (ft)	Right Shoulder Width (ft)	Grade (%)	Driveway Density (driveways/mi)	Hazard Rating	Centerline Rumble Strip	Passing Lanes	TW LT Lane	Lighting	Automated Speed Enforcement	Radius (ft)	Superelevation (%)	Adverse	Design Speed (mph)
114	2U	2099+74.790	2111+43.919	1,169.13	0.2214	2010-2014: 1,800	12.00	12.00	8.00	8.00	1.40	0.3	1	false	0	false	false	false				
115	2U	2111+43.919	2120+81.651	937.73	0.1776	2010-2014: 1,800	12.00	12.00	8.00	8.00	0.40	0.3	1	false	0	false	false	false				
116	2U	2120+81.651	2129+87.830	906.18	0.1716	2010-2014: 1,800	12.00	12.00	8.00	8.00	2.30	0.3	1	false	0	false	false	false				
117	2U	2129+87.830	2140+56.643	1,068.81	0.2024	2010-2014: 1,800	12.00	12.00	8.00	8.00	0.38	0.3	1	false	0	false	false	false				
118	2U	2140+56.643	2142+74.256	217.61	0.0412	2010-2014: 1,800	12.00	12.00	8.00	8.00	0.38	0.3	1	false	0	false	false	false	5,729.58	2.0	true	60
119	2U	2142+74.256	2168+08.627	2,534.37	0.4800	2010-2014: 1,800	12.00	12.00	8.00	8.00	2.00	0.3	1	false	0	false	false	false	5,729.58	2.0	true	60
120	2U	2168+08.627	2182+78.204	1,469.58	0.2783	2010-2014: 1,800	12.00	12.00	8.00	8.00	2.30	0.3	1	false	0	false	false	false	5,729.58	2.0	true	60
121	2U	2182+78.204	2183+26.113	47.91	0.0091	2010-2014: 1,800	12.00	12.00	8.00	8.00	3.00	0.3	1	false	0	false	false	false	5,729.58	2.0	true	60
122	2U	2183+26.113	2199+41.672	1,615.56	0.3060	2010-2014: 1,800	12.00	12.00	8.00	8.00	3.00	0.3	1	false	0	false	false	false				
123	2U	2199+41.672	2201+13.109	171.44	0.0325	2010-2014: 1,800	12.00	12.00	8.00	8.00	1.90	0.3	1	false	0	false	false	false				
124	2U	2201+13.109	2210+46.999	933.89	0.1769	2010-2014: 1,800	12.00	12.00	8.00	8.00	1.90	0.3	1	false	0	false	false	false	2,864.79	2.0	true	60
125	2U	2210+46.999	2224+50.778	1,403.78	0.2659	2010-2014: 1,800	12.00	12.00	8.00	8.00	1.90	0.3	1	false	0	false	false	false				
126	2U	2224+50.778	2238+41.687	1,390.91	0.2634	2010-2014: 1,800	12.00	12.00	8.00	8.00	0.50	0.3	1	false	0	false	false	false				
127	2U	2238+41.687	2252+38.958	1,397.27	0.2646	2010-2014: 1,800	12.00	12.00	8.00	8.00	2.50	0.3	1	false	0	false	false	false				
128	2U	2252+38.958	2253+13.131	74.17	0.0140	2010-2014: 1,800	12.00	12.00	8.00	8.00	2.50	0.3	1	false	0	false	false	false	2,788.71	2.0	true	60
129	2U	2253+13.131	2267+68.359	1,455.23	0.2756	2010-2014: 1,800	12.00	12.00	8.00	8.00	1.70	0.3	1	false	0	false	false	false	2,788.71	2.0	true	60
130	2U	2267+68.359	2271+18.026	349.67	0.0662	2010-2014: 1,800	12.00	12.00	8.00	8.00	1.70	0.3	1	false	0	false	false	false				
131	2U	2271+18.026	2275+17.825	399.80	0.0757	2010-2014: 1,800	12.00	12.00	8.00	8.00	3.50	0.3	1	false	0	false	false	false				
132	2U	2275+17.825	2283+86.397	868.57	0.1645	2010-2014: 1,800	12.00	12.00	8.00	8.00	3.50	0.3	1	false	0	false	false	false	2,788.71	2.0	true	60
133	2U	2283+86.397	2294+34.169	1,047.77	0.1984	2010-2014: 1,800	12.00	12.00	8.00	8.00	0.60	0.3	1	false	0	false	false	false	2,788.71	2.0	true	60
134	2U	2294+34.169	2297+86.147	351.98	0.0667	2010-2014: 1,800	12.00	12.00	8.00	8.00	0.00	0.3	1	false	0	false	false	false	2,788.71	2.0	true	60
135	2U	2297+86.147	2322+20.021	2,433.87	0.4610	2010-2014: 1,800	12.00	12.00	8.00	8.00	0.00	0.3	1	false	0	false	false	false				
136	2U	2322+20.021	2324+46.955	226.93	0.0430	2010-2014: 1,800	12.00	12.00	8.00	8.00	0.50	0.3	1	false	0	false	false	false				
137	2U	2324+46.955	2328+02.518	355.56	0.0673	2010-2014: 1,800	12.00	12.00	8.00	8.00	0.50	0.3	1	false	0	false	false	false	2,864.09	2.0	true	60
138	2U	2328+02.518	2335+97.505	794.99	0.1506	2010-2014: 1,800	12.00	12.00	8.00	8.00	0.00	0.3	1	false	0	false	false	false	2,864.09	2.0	true	60
139	2U	2335+97.505	2358+28.150	2,230.64	0.4225	2010-2014: 1,800	12.00	12.00	8.00	8.00	0.00	0.3	1	false	0	false	false	false				

Seg No.	Type	Start Location	End Location	Length (ft)	Length (mi)	AADT	Left Lane Width (ft)	Right Lane Width (ft)	Left Shoulder Width (ft)	Right Shoulder Width (ft)	Grade (%)	Driveway Density (driveways/mi)	Hazard Rating	Centerline Rumble Strip	Passing Lanes	TW LT Lane	Lighting	Automated Speed Enforcement	Radius (ft)	Superelevation (%)	Adverse	Design Speed (mph)
140	2U	2358+28.150	2388+01.647	2,973.50	0.5632	2010-2014: 1,800	12.00	12.00	8.00	8.00	0.14	0.3	1	false	0	false	false	false				
141	2U	2388+01.647	2392+62.777	461.13	0.0873	2010-2014: 1,800	12.00	12.00	8.00	8.00	0.14	0.3	1	false	0	false	false	false	1,909.86	2.0	true	60
142	2U	2392+62.777	2393+97.841	135.06	0.0256	2010-2014: 1,800	12.00	12.00	8.00	8.00	1.70	0.3	1	false	0	false	false	false	1,909.86	2.0	true	60
143	2U	2393+97.841	2399+08.519	510.68	0.0967	2010-2014: 1,800	12.00	12.00	8.00	8.00	1.70	0.3	1	false	0	false	false	false				
144	2U	2399+08.519	2406+75.288	766.77	0.1452	2010-2014: 1,800	12.00	12.00	8.00	8.00	1.70	0.3	1	false	0	false	false	false	1,145.92	2.0	true	60
145	2U	2406+75.288	2410+56.262	380.97	0.0722	2010-2014: 1,800	12.00	12.00	8.00	8.00	0.20	0.3	1	false	0	false	false	false	1,145.92	2.0	true	60
146	2U	2410+56.262	2413+31.488	275.23	0.0521	2010-2014: 1,800	12.00	12.00	8.00	8.00	0.20	0.3	1	false	0	false	false	false				
147	2U	2413+31.488	2415+67.769	236.28	0.0447	2010-2014: 1,800	12.00	12.00	8.00	8.00	1.00	0.3	1	false	0	false	false	false				
148	2U	2415+67.769	2417+66.491	198.72	0.0376	2010-2014: 1,800	12.00	12.00	8.00	8.00	1.00	0.3	1	false	0	false	false	false	1,145.91	2.0	true	60
149	2U	2417+66.491	2419+57.000	190.51	0.0361	2010-2014: 1,800	12.00	12.00	8.00	8.00	0.00	0.3	1	false	0	false	false	false	1,145.91	2.0	true	60
150	2U	2419+57.000	2426+42.114	685.11	0.1298	2010-2014: 1,800	12.00	12.00	8.00	8.00	0.00	0.3	1	false	0	false	false	false	1,145.91	2.0	true	60
151	2U	2426+42.114	2459+72.548	3,330.43	0.6308	2010-2014: 1,800	12.00	12.00	8.00	8.00	0.00	0.3	1	false	0	false	false	false				
152	2U	2459+72.548	2466+78.556	706.01	0.1337	2010-2014: 1,800	12.00	12.00	8.00	8.00	0.00	0.3	1	false	0	false	false	false	1,912.94	2.0	true	60
153	2U	2466+78.556	2469+46.215	267.66	0.0507	2010-2014: 1,800	12.00	12.00	8.00	8.00	0.00	0.3	1	false	0	false	false	false				

**Table 4. Expected Highway Crash Rates and Frequencies (Section 1)**

<b>First Year of Analysis</b>	2017
<b>Last Year of Analysis</b>	2017
<b>Evaluated Length (mi)</b>	21.6360
<b>Average Future Road AADT (vpd)</b>	1,800
<b>Expected Crashes</b>	
<b>Total Crashes</b>	8.38
<b>Fatal and Injury Crashes</b>	2.89
<b>Property-Damage-Only Crashes</b>	5.49
<b>Percent of Total Expected Crashes</b>	
<b>Percent Fatal and Injury Crashes (%)</b>	34
<b>Percent Property-Damage-Only Crashes (%)</b>	66
<b>Expected Crash Rate</b>	
<b>Crash Rate (crashes/mi/yr)</b>	0.3872
<b>Fatal and Injury Crash Rate (crashes/mi/yr)</b>	0.1335
<b>Property-Damage-Only Crash Rate (crashes/mi/yr)</b>	0.2537
<b>Expected Travel Crash Rate</b>	
<b>Total Travel (million veh-mi)</b>	14.21
<b>Travel Crash Rate (crashes/million veh-mi)</b>	0.59
<b>Travel Fatal and Injury Crash Rate (crashes/million veh-mi)</b>	0.20
<b>Travel Property-Damage-Only Crash Rate (crashes/million veh-mi)</b>	0.39

**Table 5. Expected Crash Frequencies and Rates by Highway Segment (Section 1)**

Segment Number/Intersection Name/Cross Road	Start Location	End Location	Length (mi)	Expected No. Crashes for Evaluation Period	Crash Rate (crashes/mi/yr)	Travel Crash Rate (crashes/million veh-mi)
1	1327+09.000	1336+44.302	0.1771	0.048	0.2683	0.41
2	1336+44.302	1345+88.891	0.1789	0.058	0.3241	0.49
3	1345+88.891	1350+43.605	0.0861	0.023	0.2619	0.40
4	1350+43.605	1355+75.006	0.1006	0.037	0.3717	0.57
5	1355+75.006	1359+98.149	0.0801	0.021	0.2683	0.41
6	1359+98.149	1375+23.561	0.2889	0.092	0.3200	0.49
7	1375+23.561	1393+00.000	0.3364	0.087	0.2601	0.40
8	1393+00.000	1401+32.606	0.1577	0.045	0.2861	0.43
9	1401+32.606	1409+13.059	0.1478	0.038	0.2601	0.40
10	1409+13.059	1414+12.992	0.0947	0.030	0.3204	0.49
11	1414+12.992	1421+34.750	0.1367	0.048	0.3510	0.53

Segment Number/Intersection Name/Cross Road	Start Location	End Location	Length (mi)	Expected No. Crashes for Evaluation Period	Crash Rate (crashes/mi/yr)	Travel Crash Rate (crashes/million veh-mi)
12	1421+34.750	1429+14.849	0.1477	0.043	0.2909	0.44
13	1429+14.849	1430+94.115	0.0340	0.013	0.3758	0.57
14	1430+94.115	1439+70.975	0.1661	0.060	0.3593	0.55
15	1439+70.975	1446+78.905	0.1341	0.041	0.3039	0.46
16	1446+78.905	1474+19.719	0.5191	0.145	0.2791	0.42
17	1474+19.719	1482+80.707	0.1631	0.116	0.7086	1.08
18	1482+80.707	1494+92.498	0.2295	0.089	0.3870	0.59
19	1494+92.498	1495+04.975	0.0024	0.001	0.3577	0.54
20	1495+04.975	1517+91.741	0.4331	0.165	0.3805	0.58
21	1517+91.741	1520+69.517	0.0526	0.050	0.9588	1.46
22	1520+69.517	1534+56.073	0.2626	0.125	0.4754	0.72
23	1534+56.073	1537+20.811	0.0501	0.016	0.3196	0.49
24	1537+20.811	1547+00.000	0.1855	0.045	0.2408	0.37
25	1547+00.000	1547+67.585	0.0128	0.003	0.2013	0.31
26	1547+67.585	1562+96.864	0.2896	0.071	0.2470	0.38
27	1562+96.864	1601+73.850	0.7343	0.235	0.3203	0.49
28	1601+73.850	1602+00.000	0.0050	0.001	0.1992	0.30
29	1602+00.000	1610+00.173	0.1515	0.043	0.2872	0.44
30	1610+00.173	1610+84.612	0.0160	0.005	0.3077	0.47
31	1610+84.612	1617+23.307	0.1210	0.042	0.3493	0.53
32	1617+23.307	1627+89.938	0.2020	0.065	0.3191	0.49
33	1627+89.938	1643+09.815	0.2879	0.261	0.9063	1.38
34	1643+09.815	1646+52.122	0.0648	0.039	0.5949	0.91
35	1646+52.122	1655+92.557	0.1781	0.078	0.4364	0.66
36	1655+92.557	1659+03.379	0.0589	0.024	0.3985	0.61
37	1659+03.379	1669+30.626	0.1946	0.068	0.3517	0.54
38	1669+30.626	1674+43.750	0.0972	0.086	0.8889	1.35
39	1674+43.750	1675+11.000	0.0127	0.023	1.8269	2.78
40	1675+11.000	1677+87.000	0.0523	0.069	1.3191	2.01
41	1677+87.000	1681+43.803	0.0676	0.070	1.0367	1.58
42	1681+43.803	1681+98.703	0.0104	0.002	0.1754	0.27
43	1681+98.703	1690+42.486	0.1598	0.043	0.2719	0.41
44	1690+42.486	1692+18.995	0.0334	0.054	1.6037	2.44
45	1692+18.995	1696+00.352	0.0722	0.116	1.6037	2.44
46	1696+00.352	1712+69.818	0.3162	0.159	0.5022	0.76
47	1712+69.818	1715+67.336	0.0563	0.011	0.1976	0.30
48	1715+67.336	1721+32.523	0.1070	0.034	0.3147	0.48
49	1721+32.523	1727+99.101	0.1262	0.026	0.2084	0.32
50	1727+99.101	1732+38.832	0.0833	0.026	0.3175	0.48
51	1732+38.832	1733+23.295	0.0160	0.003	0.1786	0.27
52	1733+23.295	1751+06.502	0.3377	0.097	0.2861	0.43
53	1751+06.502	1769+86.649	0.3561	0.067	0.1886	0.29
54	1769+86.649	1773+11.000	0.0614	0.011	0.1847	0.28
55	1773+11.000	1782+08.239	0.1699	0.048	0.2841	0.43
56	1782+08.239	1783+86.769	0.0338	0.021	0.6090	0.93
57	1783+86.769	1785+60.207	0.0328	0.009	0.2841	0.43
58	1785+60.207	1797+04.916	0.2168	0.069	0.3189	0.48
59	1797+04.916	1805+56.375	0.1613	0.090	0.5606	0.85
60	1805+56.375	1836+97.715	0.5950	0.312	0.5248	0.80
61	1836+97.715	1848+67.739	0.2216	0.087	0.3909	0.59
62	1848+67.739	1851+41.349	0.0518	0.014	0.2707	0.41



Segment Number/Intersection Name/Cross Road	Start Location	End Location	Length (mi)	Expected No. Crashes for Evaluation Period	Crash Rate (crashes/mi/yr)	Travel Crash Rate (crashes/million veh-mi)
63	1851+41.349	1857+54.083	0.1160	0.046	0.3951	0.60
64	1857+54.083	1880+88.000	0.4420	0.198	0.4468	0.68
65	1880+88.000	1883+68.000	0.0530	0.012	0.2344	0.36
66	1883+68.000	1884+55.041	0.0165	0.003	0.2031	0.31
67	1884+55.041	1890+37.663	0.1103	0.052	0.4745	0.72
68	1890+37.663	1894+28.643	0.0740	0.031	0.4233	0.64
69	1894+28.643	1905+57.352	0.2138	0.110	0.5153	0.78
70	1905+57.352	1905+75.567	0.0034	0.002	0.5072	0.77
71	1905+75.567	1929+09.242	0.4420	0.125	0.2821	0.43
72	1929+09.242	1935+82.969	0.1276	0.025	0.1919	0.29
73	1935+82.969	1972+62.568	0.6969	0.226	0.3246	0.49
74	1972+62.568	1984+13.000	0.2179	0.082	0.3740	0.57
75	1984+13.000	1997+37.976	0.2509	0.110	0.4376	0.67
76	1997+37.976	2027+35.720	0.5678	0.162	0.2861	0.43
77	2027+35.720	2043+47.648	0.3053	0.079	0.2601	0.40
78	2043+47.648	2053+08.501	0.1820	0.049	0.2673	0.41
79	2053+08.501	2067+63.430	0.2756	0.089	0.3215	0.49
80	2067+63.430	2068+50.198	0.0164	0.005	0.3215	0.49
81	2068+50.198	2082+15.567	0.2586	0.066	0.2566	0.39
82	2082+15.567	2094+20.956	0.2283	0.060	0.2633	0.40
83	2094+20.956	2104+07.717	0.1869	0.074	0.3936	0.60
84	2104+07.717	2112+43.653	0.1583	0.089	0.5627	0.86
85	2112+43.653	2120+00.000	0.1432	0.089	0.6249	0.95
86	2120+00.000	2122+66.738	0.0505	0.012	0.2461	0.38
87	2122+66.738	2124+42.138	0.0332	0.007	0.2049	0.31
88	2124+42.138	2150+23.032	0.4888	0.098	0.2013	0.31
89	2150+23.032	2165+24.800	0.2844	0.056	0.1953	0.30
90	2165+24.800	2165+36.208	0.0022	0.000	0.2148	0.33
91	2165+36.208	2180+36.257	0.2841	0.052	0.1828	0.28
92	2180+36.257	2183+23.204	0.0543	0.009	0.1662	0.25
93	2183+23.204	2192+57.094	0.1769	0.138	0.7801	1.19
94	2192+57.094	2200+00.000	0.1407	0.077	0.5468	0.83
95	2200+00.000	2206+08.668	0.1153	0.029	0.2483	0.38
96	2206+08.668	2219+36.220	0.2514	0.105	0.4196	0.64
97	2219+36.220	2234+49.053	0.2865	0.146	0.5080	0.77
98	2234+49.053	2235+79.281	0.0247	0.016	0.6648	1.01
99	2235+79.281	2249+78.454	0.2650	0.109	0.4097	0.62
100	2249+78.454	2253+09.642	0.0627	0.017	0.2638	0.40
101	2253+09.642	2257+27.920	0.0792	0.021	0.2716	0.41
102	2257+27.920	2265+11.600	0.1484	0.052	0.3479	0.53
103	2265+11.600	2279+96.243	0.2812	0.091	0.3244	0.49
104	2279+96.243	2306+57.050	0.5039	0.173	0.3437	0.52
105	2306+57.050	2318+07.600	0.2179	0.157	0.7222	1.10
106	2318+07.600	2369+89.689	0.9815	0.445	0.4535	0.69
107	2369+89.689	2375+07.219	0.0980	0.072	0.7390	1.12
108	2375+07.219	2376+29.630	0.0232	0.017	0.7390	1.12
109	2376+29.630	2381+18.255	0.0925	0.046	0.4933	0.75
110	2381+18.255	2386+93.841	0.1090	0.081	0.7387	1.12
111	2386+93.841	2392+65.999	0.1084	0.127	1.1705	1.78
112	2392+65.999	2395+41.312	0.0521	0.013	0.2500	0.38
113	2395+41.312	2397+77.506	0.0447	0.012	0.2683	0.41

Segment Number/Intersection Name/Cross Road	Start Location	End Location	Length (mi)	Expected No. Crashes for Evaluation Period	Crash Rate (crashes/mi/yr)	Travel Crash Rate (crashes/million veh-mi)
114	2397+77.506	2398+49.016	0.0135	0.005	0.4066	0.62
115	2398+49.016	2401+00.003	0.0475	0.017	0.3646	0.56
116	2401+00.003	2408+51.850	0.1424	0.050	0.3512	0.54
117	2408+51.850	2441+82.284	0.6308	0.269	0.4266	0.65
118	2441+82.284	2448+88.292	0.1337	0.053	0.4001	0.61
119	2448+88.292	2469+47.035	0.3899	0.100	0.2563	0.39

**Table 6. Expected Crash Frequencies and Rates by Horizontal Design Element (Section 1)**

Title	Start Location	End Location	Length (mi)	Expected No. Crashes for Evaluation Period	Crash Rate (crashes/mi/yr)	Travel Crash Rate (crashes/million veh-mi)
Tangent	1327+09.000	1336+44.302	0.1771	0.048	0.2683	0.41
Simple Curve 1	1336+44.302	1345+88.891	0.1789	0.058	0.3241	0.49
Tangent	1345+88.891	1350+43.605	0.0861	0.023	0.2619	0.40
Simple Curve 2	1350+43.605	1355+75.006	0.1006	0.037	0.3717	0.57
Tangent	1355+75.006	1359+98.149	0.0801	0.021	0.2683	0.41
Simple Curve 3	1359+98.149	1375+23.561	0.2889	0.092	0.3200	0.49
Tangent	1375+23.561	1409+13.059	0.6420	0.171	0.2665	0.41
Simple Curve 4	1409+13.059	1421+34.750	0.2314	0.078	0.3385	0.52
Tangent	1421+34.750	1429+14.849	0.1477	0.043	0.2909	0.44
Simple Curve 5	1429+14.849	1439+70.975	0.2000	0.072	0.3621	0.55
Tangent	1439+70.975	1482+80.707	0.8162	0.301	0.3690	0.56
Simple Curve 6	1482+80.707	1495+04.975	0.2319	0.090	0.3867	0.59
Tangent	1495+04.975	1520+69.517	0.4857	0.215	0.4431	0.67
Simple Curve 7	1520+69.517	1537+20.811	0.3127	0.141	0.4504	0.69
Tangent	1537+20.811	1547+67.585	0.1983	0.047	0.2383	0.36
Simple Curve 8	1547+67.585	1601+73.850	1.0239	0.307	0.2996	0.46
Tangent	1601+73.850	1610+00.173	0.1565	0.044	0.2844	0.43
Simple Curve 9	1610+00.173	1617+23.307	0.1370	0.047	0.3444	0.52
Tangent	1617+23.307	1627+89.938	0.2020	0.065	0.3191	0.49
Simple Curve 10	1627+89.938	1646+52.122	0.3527	0.299	0.8491	1.29
Tangent	1646+52.122	1659+03.379	0.2370	0.101	0.4269	0.65
Simple Curve 11	1659+03.379	1669+30.626	0.1946	0.068	0.3517	0.54
Tangent	1669+30.626	1674+43.750	0.0972	0.086	0.8889	1.35
Simple Curve 12	1674+43.750	1681+43.803	0.1326	0.162	1.2239	1.86
Tangent	1681+43.803	1690+42.486	0.1702	0.045	0.2660	0.40
Simple Curve 13	1690+42.486	1696+00.352	0.1057	0.169	1.6037	2.44
Tangent	1696+00.352	1715+67.336	0.3725	0.170	0.4561	0.69
Simple Curve 14	1715+67.336	1721+32.523	0.1070	0.034	0.3147	0.48
Tangent	1721+32.523	1727+99.101	0.1262	0.026	0.2084	0.32
Simple Curve 15	1727+99.101	1732+38.832	0.0833	0.026	0.3175	0.48
Tangent	1732+38.832	1782+08.239	0.9412	0.226	0.2404	0.37
Simple Curve 16	1782+08.239	1783+86.769	0.0338	0.021	0.6090	0.93
Tangent	1783+86.769	1797+04.916	0.2496	0.079	0.3143	0.48
Simple Curve 17	1797+04.916	1805+56.375	0.1613	0.090	0.5606	0.85
Tangent	1805+56.375	1836+97.715	0.5950	0.312	0.5248	0.80

Title	Start Location	End Location	Length (mi)	Expected No. Crashes for Evaluation Period	Crash Rate (crashes/mi/yr)	Travel Crash Rate (crashes/million veh-mi)
Simple Curve 18	1836+97.715	1848+67.739	0.2216	0.087	0.3909	0.59
Tangent	1848+67.739	1851+41.349	0.0518	0.014	0.2707	0.41
Simple Curve 19	1851+41.349	1857+54.083	0.1160	0.046	0.3951	0.60
Tangent	1857+54.083	1884+55.041	0.5115	0.213	0.4169	0.64
Simple Curve 20	1884+55.041	1890+37.663	0.1103	0.052	0.4745	0.72
Tangent	1890+37.663	1894+28.643	0.0740	0.031	0.4233	0.64
Simple Curve 21	1894+28.643	1905+57.352	0.2138	0.110	0.5153	0.78
Tangent	1905+57.352	2053+08.501	2.7938	0.859	0.3075	0.47
Simple Curve 22	2053+08.501	2068+50.198	0.2920	0.094	0.3215	0.49
Tangent	2068+50.198	2122+66.738	1.0259	0.391	0.3812	0.58
Simple Curve 23	2122+66.738	2165+36.208	0.8086	0.161	0.1994	0.30
Tangent	2165+36.208	2183+23.204	0.3384	0.061	0.1801	0.27
Simple Curve 24	2183+23.204	2192+57.094	0.1769	0.138	0.7801	1.19
Tangent	2192+57.094	2234+49.053	0.7939	0.357	0.4492	0.68
Simple Curve 25	2234+49.053	2249+78.454	0.2897	0.125	0.4315	0.66
Tangent	2249+78.454	2257+27.920	0.1419	0.038	0.2681	0.41
Simple Curve 26	2257+27.920	2279+96.243	0.4296	0.143	0.3325	0.51
Tangent	2279+96.243	2306+57.050	0.5039	0.173	0.3437	0.52
Simple Curve 27	2306+57.050	2318+07.600	0.2179	0.157	0.7222	1.10
Tangent	2318+07.600	2369+89.689	0.9815	0.445	0.4535	0.69
Simple Curve 28	2369+89.689	2376+29.630	0.1212	0.090	0.7390	1.12
Tangent	2376+29.630	2381+18.255	0.0925	0.046	0.4933	0.75
Simple Curve 29	2381+18.255	2392+65.999	0.2174	0.207	0.9540	1.45
Tangent	2392+65.999	2397+77.506	0.0969	0.025	0.2585	0.39
Simple Curve 30	2397+77.506	2408+51.850	0.2035	0.073	0.3580	0.55
Tangent	2408+51.850	2441+82.284	0.6308	0.269	0.4266	0.65
Simple Curve 31	2441+82.284	2448+88.292	0.1337	0.053	0.4001	0.61
Tangent	2448+88.292	2469+47.035	0.3899	0.100	0.2563	0.39

**Table 7. Expected Segment Crash Type Distribution (Section 1)**

Element Type	Crash Type	FI Crashes	Percent FI (%)	PDO Crashes	Percent PDO (%)	Total Crashes	Percent Total (%)
Highway Segment	Collision with Animal	0.11	1.3	1.01	12.1	1.01	12.1
Highway Segment	Collision with Bicycle	0.01	0.1	0.01	0.1	0.02	0.2
Highway Segment	Other Single-vehicle Collision	0.02	0.2	0.16	1.9	0.18	2.1
Highway Segment	Overturned	0.11	1.3	0.08	1.0	0.21	2.5
Highway Segment	Collision with Pedestrian	0.02	0.2	0.01	0.1	0.03	0.3
Highway Segment	Run Off Road	1.57	18.8	2.77	33.1	4.36	52.1
Highway Segment	Total Single Vehicle Crashes	1.84	22.0	4.03	48.2	5.80	69.3
Highway Segment	Angle Collision	0.29	3.5	0.40	4.7	0.71	8.5
Highway Segment	Head-on Collision	0.10	1.2	0.02	0.2	0.13	1.6
Highway Segment	Other Multiple-vehicle Collision	0.07	0.9	0.17	2.0	0.23	2.7
Highway Segment	Rear-end Collision	0.48	5.7	0.67	8.0	1.19	14.2
Highway Segment	Sideswipe	0.11	1.3	0.21	2.5	0.31	3.7
Highway Segment	Total Multiple Vehicle Crashes	1.05	12.6	1.45	17.4	2.57	30.7
Highway Segment	Total Highway Segment Crashes	2.89	34.5	5.49	65.5	8.38	100.0
	Total Crashes	2.89	34.5	5.49	65.5	8.38	100.0

**Note:** *Fatal and Injury Crashes* and *Property Damage Only Crashes* do not necessarily sum up to *Total Crashes* because the distribution of these three crashes had been derived independently.

*Interactive Highway Safety Design Model*

**Crash Prediction Evaluation Report**

**P2 Alignment Alternative**

January 18, 2018



## **Disclaimer**

The Interactive Highway Design Model (IHSDM) software is disseminated under the sponsorship of the Department of Transportation in the interest of information exchange. The United States Government assumes no liability for its content or use thereof. This document does not constitute a standard, specification, or regulation.

The United States Government does not endorse products or manufacturers. Trade and manufacturers' names may appear in this software and documentation only because they are considered essential to the objective of the software.

## **Limited Warranty and Limitations of Remedies**

This software product is provided "as-is," without warranty of any kind-either expressed or implied (but not limited to the implied warranties of merchantability and fitness for a particular purpose). The FHWA do not warrant that the functions contained in the software will meet the end-user's requirements or that the operation of the software will be uninterrupted and error-free.

Under no circumstances will the FHWA be liable to the end-user for any damages or claimed lost profits, lost savings, or other incidental or consequential damages rising out of the use or inability to use the software (even if these organizations have been advised of the possibility of such damages), or for any claim by any other party.

## **Notice**

The use of the IHSDM software is being done strictly on a voluntary basis. In exchange for provision of IHSDM, the user agrees that the Federal Highway Administration (FHWA), U.S. Department of Transportation and any other agency of the Federal Government shall not be responsible for any errors, damage or other liability that may result from any and all use of the software, including installation and testing of the software. The user further agrees to hold the FHWA and the Federal Government harmless from any resulting liability. The user agrees that this hold harmless provision shall flow to any person to whom or any entity to which the user provides the IHSDM software. It is the user's full responsibility to inform any person to whom or any entity to which it provides the IHSDM software of this hold harmless provision.

---

---

## Table of Contents

<b>Report Overview</b> .....	<b>1</b>
<b>Section 1 Evaluation</b> .....	<b>2</b>

## List of Tables

Table Observed Crashes Used in the Evaluation (Section 1) .....	3
Table Evaluation Highway - Homogeneous Segments (Section 1) .....	4
Table Crash History Highway - Homogeneous Segments (Section 1) .....	7
Table Expected Highway Crash Rates and Frequencies (Section 1) .....	13
Table Expected Crash Frequencies and Rates by Highway Segment (Section 1) .....	13
Table Expected Crash Frequencies and Rates by Horizontal Design Element (Section 1) .....	16
Table Expected Segment Crash Type Distribution (Section 1) .....	18

## List of Figures

Figure Crash Prediction Summary (Section 1) .....	2
---	---



## Report Overview

**Report Generated:** Jan 18, 2018 8:52 AM

**Report Template:** System: Multi-Page, 508 Compliant [System] (mlcpm4, Oct 9, 2017 1:45 PM)

**Evaluation Date:** Tue Jan 16 15:46:41 AKST 2018

**IHSDM Version:** v13.0.0 (Sep 13, 2017)

**Crash Prediction Module:** v8.0.0 (Sep 13, 2017)

**User Name:** RaeAnne Hebnes

**Organization Name:** Michael Baker International

**Phone:**

**E-Mail:**

**Project Title:** Parks 305 - 325 v2

**Project Comment:** Created using wizard

**Project Unit System:** U.S. Customary

**Highway Title:** Alignment P2\_1dec2017

**Highway Comment:** Alignment P2\_1dec2017

**Highway Version:** 1

**Evaluation Title:** Evaluation 7

**Evaluation Comment:** Created Tue Jan 16 15:43:52 AKST 2018

**Minimum Station:** 1327+09.000

**Maximum Station:** 2424+38.143

**Policy for Superelevation:** AASHTO 2011 U.S. Customary

**Calibration:** HSM Configuration

**Crash Distribution:** HSM Configuration

**Model/CMF:** HSM Configuration

**Empirical-Bayes Analysis:** Site-Specific

**Highway with Crash History:** Alignment ParksHwy304-326 Asbuilt - 60 mph

**Highway with Crash History Comment:** Created By Civil Geometry

**Highway with Crash History Version:** 1

**First Year of Analysis:** 2017

**Last Year of Analysis:** 2017

# Section 1 Evaluation

**Section:** Section 1  
**Evaluation Start Location:** 1327+09.000  
**Evaluation End Location:** 2424+38.143  
**Area Type:** Rural  
**Functional Class:** Arterial  
**Type of Alignment:** Undivided, Two Lane  
**Model Category:** Rural, Two Lane  
**Calibration Factor:** 2U=1.0;

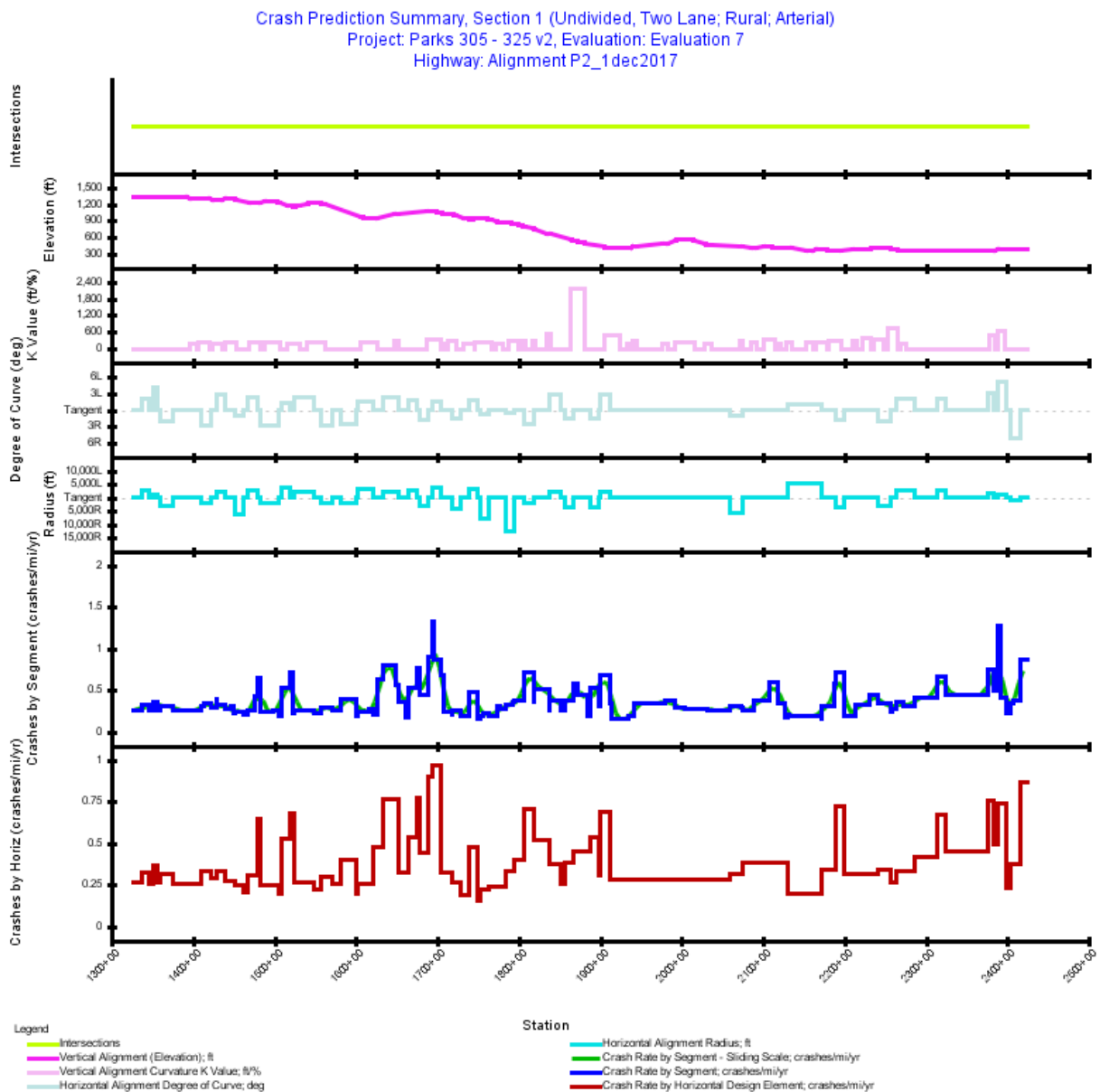

**Figure 1. Crash Prediction Summary (Section 1)**

**Table 1. Observed Crashes Used in the Evaluation (Section 1)**

Year	Observed Crashes	Total Crashes Used	FI Crashes	FI no/C Crashes	PDO Crashes
2010	9	7	3	1	4
2011	6	6	2	0	4
2012	7	7	2	0	5
2013	6	6	3	0	3
2014	17	16	7	0	9
All Years	45 &nbsp; <sup>[1]</sup>	42	17	1	25

**Footnotes**

<sup>[1]</sup> Note: Observed crash data that does not comply with the associated CPM model requirements may not be used in EB processing.

**Table 2. Evaluation Highway - Homogeneous Segments (Section 1)**

Seg. No.	Type	Start Location	End Location	Length (ft)	Length(mi)	AADT	Left Lane Width (ft)	Right Lane Width (ft)	Left Shoulder Width (ft)	Right Shoulder Width (ft)	Grade (%)	Driveway Density (driveways/m i)	Hazard Rating	Centerline Rumble Strip	Passing Lanes	TWLT Lane	Lighting	Automated Speed Enforcement	Radius (ft)	Superelevation (%)	Adverse	Design Speed (mph)
1	2U	1327+09.000	1336+44.302	935.30	0.1771	2017: 1,800	12.00	12.00	8.00	8.00	0.00	0.3	1	false	0	false	false	false				
2	2U	1336+44.302	1345+88.891	944.59	0.1789	2017: 1,800	12.00	12.00	8.00	8.00	0.00	0.3	1	false	0	false	false	false	2,864.79	2.0	true	70
3	2U	1345+88.891	1350+43.605	454.71	0.0861	2017: 1,800	12.00	12.00	8.00	8.00	0.00	0.3	1	false	0	false	false	false				
4	2U	1350+43.605	1355+75.006	531.40	0.1006	2017: 1,800	12.00	12.00	8.00	8.00	0.00	0.3	1	false	0	false	false	false	1,432.40	2.0	true	70
5	2U	1355+75.006	1359+98.149	423.14	0.0801	2017: 1,800	12.00	12.00	8.00	8.00	0.00	0.3	1	false	0	false	false	false				
6	2U	1359+98.149	1375+23.561	1,525.41	0.2889	2017: 1,800	12.00	12.00	8.00	8.00	0.00	0.3	1	false	0	false	false	false	2,864.79	2.0	true	70
7	2U	1375+23.561	1393+00.000	1,776.44	0.3365	2017: 1,800	12.00	12.00	8.00	8.00	0.00	0.3	1	false	0	false	false	false				
8	2U	1393+00.000	1400+30.565	730.57	0.1384	2017: 1,800	12.00	12.00	8.00	8.00	3.00	0.3	1	false	0	false	false	false				
9	2U	1400+30.565	1409+13.059	882.49	0.1671	2017: 1,800	12.00	12.00	8.00	8.00	2.10	0.3	1	false	0	false	false	false				
10	2U	1409+13.059	1414+04.404	491.35	0.0931	2017: 1,800	12.00	12.00	8.00	8.00	2.10	0.3	1	false	0	false	false	false	2,050.00	2.0	true	70
11	2U	1414+04.404	1421+34.750	730.35	0.1383	2017: 1,800	12.00	12.00	8.00	8.00	3.50	0.3	1	false	0	false	false	false	2,050.00	2.0	true	70
12	2U	1421+34.750	1429+14.713	779.96	0.1477	2017: 1,800	12.00	12.00	8.00	8.00	3.50	0.3	1	false	0	false	false	false				
13	2U	1429+14.713	1429+71.777	57.06	0.0108	2017: 1,800	12.00	12.00	8.00	8.00	3.50	0.3	1	false	0	false	false	false	2,050.00	2.0	true	70
14	2U	1429+71.777	1439+70.699	998.92	0.1892	2017: 1,800	12.00	12.00	8.00	8.00	2.32	0.3	1	false	0	false	false	false	2,050.00	2.0	true	70
15	2U	1439+70.699	1446+51.376	680.68	0.1289	2017: 1,800	12.00	12.00	8.00	8.00	2.32	0.3	1	false	0	false	false	false				
16	2U	1446+51.376	1449+40.000	288.62	0.0547	2017: 1,800	12.00	12.00	8.00	8.00	3.50	0.3	1	false	0	false	false	false				
17	2U	1449+40.000	1451+33.375	193.38	0.0366	2017: 1,800	12.00	12.00	8.00	8.00	3.50	0.3	1	false	1	false	false	false				
18	2U	1451+33.375	1461+98.062	1,064.69	0.2016	2017: 1,800	12.00	12.00	8.00	8.00	3.50	0.3	1	false	1	false	false	false	6,100.00	2.0	true	70
19	2U	1461+98.062	1467+73.811	575.75	0.1090	2017: 1,800	12.00	12.00	8.00	8.00	3.50	0.3	1	false	1	false	false	false				
20	2U	1467+73.811	1475+38.715	764.90	0.1449	2017: 1,800	12.00	12.00	8.00	8.00	3.50	0.3	1	false	1	false	false	false	2,600.00	2.0	true	70
21	2U	1475+38.715	1478+43.352	304.64	0.0577	2017: 1,800	12.00	12.00	8.00	8.00	2.89	0.3	1	false	1	false	false	false	2,600.00	2.0	true	70
22	2U	1478+43.352	1483+12.985	469.63	0.0890	2017: 1,800	12.00	12.00	8.00	8.00	2.89	0.3	1	false	1	false	false	false				
23	2U	1483+12.985	1497+77.648	1,464.66	0.2774	2017: 1,800	12.00	12.00	8.00	8.00	2.89	0.3	1	false	1	false	false	false	2,050.00	2.0	true	70
24	2U	1497+77.648	1505+09.701	732.05	0.1386	2017: 1,800	12.00	12.00	8.00	8.00	5.00	0.3	1	false	1	false	false	false	2,050.00	2.0	true	70
25	2U	1505+09.701	1507+88.933	279.23	0.0529	2017: 1,800	12.00	12.00	8.00	8.00	5.00	0.3	1	false	1	false	false	false				
26	2U	1507+88.933	1518+44.144	1,055.21	0.1998	2017: 1,800	12.00	12.00	8.00	8.00	5.00	0.3	1	false	1	false	false	false	4,100.00	2.0	true	70
27	2U	1518+44.144	1523+30.687	486.54	0.0921	2017: 1,800	12.00	12.00	8.00	8.00	5.00	0.3	1	false	1	false	false	false				
28	2U	1523+30.687	1523+64.397	33.71	0.0064	2017: 1,800	12.00	12.00	8.00	8.00	3.77	0.3	1	false	1	false	false	false				
29	2U	1523+64.397	1548+64.398	2,500.00	0.4735	2017: 1,800	12.00	12.00	8.00	8.00	3.77	0.3	1	false	1	false	false	false	2,500.00	2.0	true	70
30	2U	1548+64.398	1551+09.491	245.09	0.0464	2017: 1,800	12.00	12.00	8.00	8.00	3.77	0.3	1	false	1	false	false	false				
31	2U	1551+09.491	1556+63.827	554.34	0.1050	2017: 1,800	12.00	12.00	8.00	8.00	5.00	0.3	1	false	1	false	false	false				
32	2U	1556+63.827	1570+18.580	1,354.75	0.2566	2017: 1,800	12.00	12.00	8.00	8.00	5.00	0.3	1	false	1	false	false	false	2,047.00	2.0	true	70
33	2U	1570+18.580	1581+42.155	1,123.58	0.2128	2017: 1,800	12.00	12.00	8.00	8.00	5.00	0.3	1	false	1	false	false	false				
34	2U	1581+42.155	1600+40.495	1,898.34	0.3595	2017: 1,800	12.00	12.00	8.00	8.00	5.00	0.3	1	false	1	false	false	false	2,153.00	2.0	true	70
35	2U	1600+40.495	1602+30.336	189.84	0.0360	2017: 1,800	12.00	12.00	8.00	8.00	5.00	0.3	1	false	1	false	false	false				
36	2U	1602+30.336	1615+87.225	1,356.89	0.2570	2017: 1,800	12.00	12.00	8.00	8.00	5.00	0.3	1	false	1	false	false	false	3,600.00	2.0	true	70
37	2U	1615+87.225	1621+46.738	559.51	0.1060	2017: 1,800	12.00	12.00	8.00	8.00	3.11	0.3	1	false	1	false	false	false	3,600.00	2.0	true	70
38	2U	1621+46.738	1625+91.000	444.26	0.0841	2017: 1,800	12.00	12.00	8.00	8.00	3.11	0.3	1	false	1	false	false	false				
39	2U	1625+91.000	1633+46.402	755.40	0.1431	2017: 1,800	12.00	12.00	8.00	8.00	3.11	0.3	1	false	0	false	false	false				
40	2U	1633+46.402	1649+14.793	1,568.39	0.2970	2017: 1,800	12.00	12.00	8.00	8.00	3.11	0.3	1	false	0	false	false	false	2,550.00	2.0	true	70

Seg. No.	Type	Start Location	End Location	Length (ft)	Length(mi)	AADT	Left Lane Width (ft)	Right Lane Width (ft)	Left Shoulder Width (ft)	Right Shoulder Width (ft)	Grade (%)	Driveway Density (driveways/m i)	Hazard Rating	Centerline Rumble Strip	Passing Lanes	TWLT Lane	Lighting	Automated Speed Enforcement	Radius (ft)	Superelevation (%)	Adverse	Design Speed (mph)
41	2U	1649+14.793	1652+11.160	296.37	0.0561	2017: 1,800	12.00	12.00	8.00	8.00	1.01	0.3	1	false	0	false	false	false	2,550.00	2.0	true	70
42	2U	1652+11.160	1661+79.000	967.84	0.1833	2017: 1,800	12.00	12.00	8.00	8.00	1.01	0.3	1	false	0	false	false	false				
43	2U	1661+79.000	1664+36.565	257.56	0.0488	2017: 1,800	12.00	12.00	8.00	8.00	1.01	0.3	1	false	2	false	false	false				
44	2U	1664+36.565	1675+12.295	1,075.73	0.2037	2017: 1,800	12.00	12.00	8.00	8.00	1.01	0.3	1	false	2	false	false	false	3,000.00	2.0	true	70
45	2U	1675+12.295	1678+20.135	307.84	0.0583	2017: 1,800	12.00	12.00	8.00	8.00	1.01	0.3	1	false	2	false	false	false				
46	2U	1678+20.135	1688+79.987	1,059.85	0.2007	2017: 1,800	12.00	12.00	8.00	8.00	1.01	0.3	1	false	2	false	false	false	3,100.00	2.0	true	70
47	2U	1688+79.987	1693+40.960	460.97	0.0873	2017: 1,800	12.00	12.00	8.00	8.00	1.01	0.3	1	false	2	false	false	false				
48	2U	1693+40.960	1695+70.734	229.77	0.0435	2017: 1,800	12.00	12.00	8.00	8.00	1.01	0.3	1	false	2	false	false	false	3,900.00	2.0	true	70
49	2U	1695+70.734	1704+03.820	833.09	0.1578	2017: 1,800	12.00	12.00	8.00	8.00	4.00	0.3	1	false	2	false	false	false	3,900.00	2.0	true	70
50	2U	1704+03.820	1706+93.795	289.98	0.0549	2017: 1,800	12.00	12.00	8.00	8.00	4.00	0.3	1	false	2	false	false	false				
51	2U	1706+93.795	1718+16.939	1,123.14	0.2127	2017: 1,800	12.00	12.00	8.00	8.00	0.71	0.3	1	false	2	false	false	false				
52	2U	1718+16.939	1718+73.301	56.36	0.0107	2017: 1,800	12.00	12.00	8.00	8.00	5.00	0.3	1	false	2	false	false	false				
53	2U	1718+73.301	1729+24.812	1,051.51	0.1991	2017: 1,800	12.00	12.00	8.00	8.00	5.00	0.3	1	false	2	false	false	false	4,000.00	2.0	true	70
54	2U	1729+24.812	1738+90.122	965.31	0.1828	2017: 1,800	12.00	12.00	8.00	8.00	5.00	0.3	1	false	2	false	false	false				
55	2U	1738+90.122	1739+01.335	11.21	0.0021	2017: 1,800	12.00	12.00	8.00	8.00	5.00	0.3	1	false	2	false	false	false	3,100.00	2.0	true	70
56	2U	1739+01.335	1749+60.945	1,059.61	0.2007	2017: 1,800	12.00	12.00	8.00	8.00	2.72	0.3	1	false	2	false	false	false	3,100.00	2.0	true	70
57	2U	1749+60.945	1753+37.825	376.88	0.0714	2017: 1,800	12.00	12.00	8.00	8.00	2.72	0.3	1	false	2	false	false	false				
58	2U	1753+37.825	1756+19.308	281.48	0.0533	2017: 1,800	12.00	12.00	8.00	8.00	2.72	0.3	1	false	2	false	false	false	8,000.00	2.0	true	70
59	2U	1756+19.308	1763+99.822	780.51	0.1478	2017: 1,800	12.00	12.00	8.00	8.00	5.00	0.3	1	false	2	false	false	false	8,000.00	2.0	true	70
60	2U	1763+99.822	1773+79.000	979.18	0.1855	2017: 1,800	12.00	12.00	8.00	8.00	5.00	0.3	1	false	2	false	false	false				
61	2U	1773+79.000	1776+44.892	265.89	0.0504	2017: 1,800	12.00	12.00	8.00	8.00	5.00	0.3	1	false	0	false	false	false				
62	2U	1776+44.892	1783+38.648	693.76	0.1314	2017: 1,800	12.00	12.00	8.00	8.00	0.27	0.3	1	false	0	false	false	false				
63	2U	1783+38.648	1793+15.024	976.38	0.1849	2017: 1,800	12.00	12.00	8.00	8.00	0.27	0.3	1	false	0	false	false	false	12,700.00	2.0	true	70
64	2U	1793+15.024	1793+95.145	80.12	0.0152	2017: 1,800	12.00	12.00	8.00	8.00	4.85	0.3	1	false	0	false	false	false	12,700.00	2.0	true	70
65	2U	1793+95.145	1806+14.814	1,219.67	0.2310	2017: 1,800	12.00	12.00	8.00	8.00	4.85	0.3	1	false	0	false	false	false				
66	2U	1806+14.814	1806+82.524	67.71	0.0128	2017: 1,800	12.00	12.00	8.00	8.00	3.24	0.3	1	false	0	false	false	false				
67	2U	1806+82.524	1818+59.631	1,177.11	0.2229	2017: 1,800	12.00	12.00	8.00	8.00	3.24	0.3	1	false	0	false	false	false	2,150.00	2.0	true	70
68	2U	1818+59.631	1819+02.306	42.67	0.0081	2017: 1,800	12.00	12.00	8.00	8.00	5.00	0.3	1	false	0	false	false	false	2,150.00	2.0	true	70
69	2U	1819+02.306	1837+08.045	1,805.74	0.3420	2017: 1,800	12.00	12.00	8.00	8.00	5.00	0.3	1	false	0	false	false	false				
70	2U	1837+08.045	1837+12.472	4.43	0.0008	2017: 1,800	12.00	12.00	8.00	8.00	3.95	0.3	1	false	0	false	false	false				
71	2U	1837+12.472	1852+14.359	1,501.89	0.2844	2017: 1,800	12.00	12.00	8.00	8.00	3.95	0.3	1	false	0	false	false	false	2,050.00	2.0	true	70
72	2U	1852+14.359	1855+90.269	375.91	0.0712	2017: 1,800	12.00	12.00	8.00	8.00	3.95	0.3	1	false	0	false	false	false				
73	2U	1855+90.269	1866+66.290	1,076.02	0.2038	2017: 1,800	12.00	12.00	8.00	8.00	3.95	0.3	1	false	0	false	false	false	3,600.00	2.0	true	70
74	2U	1866+66.290	1872+40.458	574.17	0.1087	2017: 1,800	12.00	12.00	8.00	8.00	3.95	0.3	1	false	0	false	false	false				
75	2U	1872+40.458	1884+00.000	1,159.54	0.2196	2017: 1,800	12.00	12.00	8.00	8.00	3.16	0.3	1	false	0	false	false	false				
76	2U	1884+00.000	1887+17.885	317.88	0.0602	2017: 1,800	12.00	12.00	8.00	8.00	3.16	0.3	1	false	2	false	false	false				
77	2U	1887+17.885	1897+69.447	1,051.56	0.1992	2017: 1,800	12.00	12.00	8.00	8.00	3.16	0.3	1	false	2	false	false	false	3,700.00	2.0	true	70
78	2U	1897+69.447	1900+15.731	246.28	0.0466	2017: 1,800	12.00	12.00	8.00	8.00	3.16	0.3	1	false	2	false	false	false				
79	2U	1900+15.731	1911+44.501	1,128.77	0.2138	2017: 1,800	12.00	12.00	8.00	8.00	3.16	0.3	1	false	2	false	false	false	2,050.00	2.0	true	70
80	2U	1911+44.501	1914+69.648	325.15	0.0616	2017: 1,800	12.00	12.00	8.00	8.00	3.16	0.3	1	false	2	false	false	false				
81	2U	1914+69.648	1935+13.440	2,043.79	0.3871	2017: 1,800	12.00	12.00	8.00	8.00	0.89	0.3	1	false	2	false	false	false				
82	2U	1935+13.440	1942+14.172	700.73	0.1327	2017: 1,800	12.00	12.00	8.00	8.00	3.42	0.3	1	false	2	false	false	false				
83	2U	1942+14.172	1979+48.414	3,734.24	0.7072	2017: 1,800	12.00	12.00	8.00	8.00	1.25	0.3	1	false	2	false	false	false				

Seg. No.	Type	Start Location	End Location	Length (ft)	Length (mi)	AADT	Left Lane Width (ft)	Right Lane Width (ft)	Left Shoulder Width (ft)	Right Shoulder Width (ft)	Grade (%)	Driveway Density (driveways/mi)	Hazard Rating	Centerline Rumble Strip	Passing Lanes	TWLT Lane	Lighting	Automated Speed Enforcement	Radius (ft)	Superelevation (%)	Adverse	Design Speed (mph)
84	2U	1979+48.414	1990+96.000	1,147.59	0.2173	2017: 1,800	12.00	12.00	8.00	8.00	5.00	0.3	1	false	2	false	false	false				
85	2U	1990+96.000	2004+08.375	1,312.38	0.2486	2017: 1,800	12.00	12.00	8.00	8.00	5.00	0.3	1	false	0	false	false	false				
86	2U	2004+08.375	2032+26.622	2,818.25	0.5338	2017: 1,800	12.00	12.00	8.00	8.00	5.00	0.3	1	false	0	false	false	false				
87	2U	2032+26.622	2059+91.129	2,764.51	0.5236	2017: 1,800	12.00	12.00	8.00	8.00	0.62	0.3	1	false	0	false	false	false				
88	2U	2059+91.129	2073+83.086	1,391.96	0.2636	2017: 1,800	12.00	12.00	8.00	8.00	0.62	0.3	1	false	0	false	false	false	5,729.58	2.0	true	70
89	2U	2073+83.086	2075+32.995	149.91	0.0284	2017: 1,800	12.00	12.00	8.00	8.00	1.90	0.3	1	false	0	false	false	false	5,729.58	2.0	true	70
90	2U	2075+32.995	2088+98.505	1,365.51	0.2586	2017: 1,800	12.00	12.00	8.00	8.00	1.90	0.3	1	false	0	false	false	false				
91	2U	2088+98.505	2107+64.701	1,866.20	0.3534	2017: 1,800	12.00	12.00	8.00	8.00	1.37	0.3	1	false	0	false	false	false				
92	2U	2107+64.701	2118+80.968	1,116.27	0.2114	2017: 1,800	12.00	12.00	8.00	8.00	2.49	0.3	1	false	0	false	false	false				
93	2U	2118+80.968	2127+46.000	865.03	0.1638	2017: 1,800	12.00	12.00	8.00	8.00	0.49	0.3	1	false	0	false	false	false				
94	2U	2127+46.000	2129+49.536	203.54	0.0386	2017: 1,800	12.00	12.00	8.00	8.00	0.49	0.3	1	false	2	false	false	false				
95	2U	2129+49.536	2132+09.424	259.89	0.0492	2017: 1,800	12.00	12.00	8.00	8.00	0.49	0.3	1	false	2	false	false	false	5,729.58	2.0	true	70
96	2U	2132+09.424	2156+63.518	2,454.09	0.4648	2017: 1,800	12.00	12.00	8.00	8.00	2.11	0.3	1	false	2	false	false	false	5,729.58	2.0	true	70
97	2U	2156+63.518	2172+19.006	1,555.49	0.2946	2017: 1,800	12.00	12.00	8.00	8.00	2.21	0.3	1	false	2	false	false	false	5,729.58	2.0	true	70
98	2U	2172+19.006	2172+26.614	7.61	0.0014	2017: 1,800	12.00	12.00	8.00	8.00	2.21	0.3	1	false	2	false	false	false				
99	2U	2172+26.614	2188+12.331	1,585.72	0.3003	2017: 1,800	12.00	12.00	8.00	8.00	3.26	0.3	1	false	2	false	false	false				
100	2U	2188+12.331	2189+34.430	122.10	0.0231	2017: 1,800	12.00	12.00	8.00	8.00	2.00	0.3	1	false	2	false	false	false				
101	2U	2189+34.430	2200+10.193	1,075.76	0.2037	2017: 1,800	12.00	12.00	8.00	8.00	2.00	0.3	1	false	2	false	false	false	3,300.00	2.0	true	70
102	2U	2200+10.193	2212+68.167	1,257.97	0.2382	2017: 1,800	12.00	12.00	8.00	8.00	2.00	0.3	1	false	2	false	false	false				
103	2U	2212+68.167	2227+11.813	1,443.65	0.2734	2017: 1,800	12.00	12.00	8.00	8.00	0.41	0.3	1	false	2	false	false	false				
104	2U	2227+11.813	2230+62.000	350.19	0.0663	2017: 1,800	12.00	12.00	8.00	8.00	2.34	0.3	1	false	2	false	false	false				
105	2U	2230+62.000	2241+30.583	1,068.58	0.2024	2017: 1,800	12.00	12.00	8.00	8.00	2.34	0.3	1	false	0	false	false	false				
106	2U	2241+30.583	2242+42.790	112.21	0.0213	2017: 1,800	12.00	12.00	8.00	8.00	2.34	0.3	1	false	0	false	false	false	2,788.70	2.0	true	70
107	2U	2242+42.790	2256+59.979	1,417.19	0.2684	2017: 1,800	12.00	12.00	8.00	8.00	1.64	0.3	1	false	0	false	false	false	2,788.70	2.0	true	70
108	2U	2256+59.979	2259+05.408	245.43	0.0465	2017: 1,800	12.00	12.00	8.00	8.00	1.64	0.3	1	false	0	false	false	false				
109	2U	2259+05.408	2264+09.452	504.04	0.0955	2017: 1,800	12.00	12.00	8.00	8.00	3.40	0.3	1	false	0	false	false	false				
110	2U	2264+09.452	2272+06.202	796.75	0.1509	2017: 1,800	12.00	12.00	8.00	8.00	3.40	0.3	1	false	0	false	false	false	2,788.70	2.0	true	70
111	2U	2272+06.202	2286+77.767	1,471.57	0.2787	2017: 1,800	12.00	12.00	8.00	8.00	0.10	0.3	1	false	0	false	false	false	2,788.70	2.0	true	70
112	2U	2286+77.767	2313+38.578	2,660.81	0.5039	2017: 1,800	12.00	12.00	8.00	8.00	0.10	0.3	1	false	0	false	false	false				
113	2U	2313+38.578	2324+89.129	1,150.55	0.2179	2017: 1,800	12.00	12.00	8.00	8.00	0.10	0.3	1	false	0	false	false	false	2,864.09	2.0	true	70
114	2U	2324+89.129	2376+93.270	5,204.14	0.9856	2017: 1,800	12.00	12.00	8.00	8.00	0.10	0.3	1	false	0	false	false	false				
115	2U	2376+93.270	2381+06.049	412.78	0.0782	2017: 1,800	12.00	12.00	8.00	8.00	0.10	0.3	1	false	0	false	false	false	1,909.86	2.0	true	70
116	2U	2381+06.049	2382+89.464	183.41	0.0347	2017: 1,800	12.00	12.00	8.00	8.00	1.65	0.3	1	false	0	false	false	false	1,909.86	2.0	true	70
117	2U	2382+89.464	2388+00.142	510.68	0.0967	2017: 1,800	12.00	12.00	8.00	8.00	1.65	0.3	1	false	0	false	false	false				
118	2U	2388+00.142	2392+46.808	446.67	0.0846	2017: 1,800	12.00	12.00	8.00	8.00	1.65	0.3	1	false	0	false	false	false	1,145.92	2.0	true	70
119	2U	2392+46.808	2399+47.886	701.08	0.1328	2017: 1,800	12.00	12.00	8.00	8.00	0.46	0.3	1	false	0	false	false	false	1,145.92	2.0	true	70
120	2U	2399+47.886	2404+59.393	511.51	0.0969	2017: 1,800	12.00	12.00	8.00	8.00	0.46	0.3	1	false	0	false	false	false				
121	2U	2404+59.393	2407+00.000	240.61	0.0456	2017: 1,800	12.00	12.00	8.00	8.00	0.46	0.3	1	false	0	false	false	false	1,145.91	2.0	true	70
122	2U	2407+00.000	2415+33.737	833.74	0.1579	2017: 1,800	12.00	12.00	8.00	8.00	0.00	0.3	1	false	0	false	false	false	1,145.91	2.0	true	70
123	2U	2415+33.737	2424+38.143	904.41	0.1713	2017: 1,800	12.00	12.00	8.00	8.00	0.00	0.3	1	false	0	false	false	false				

**Table 3. Crash History Highway - Homogeneous Segments (Section 1)**

Seg. No.	Type	Start Location	End Location	Length (ft)	Length (mi)	AADT	Left Lane Width (ft)	Right Lane Width (ft)	Left Shoulder Width (ft)	Right Shoulder Width (ft)	Grade (%)	Driveway Density (driveways/mi)	Hazard Rating	Centerline Rumble Strip	Passing Lanes	TW LT Lane	Lighting	Automated Speed Enforcement	Radius (ft)	Superelevation (%)	Adverse	Design Speed (mph)
1	2U	1327+09.000	1336+44.302	935.30	0.177	2010-2014: 1,800	12.00	12.00	8.00	8.00	0.00	0.3	1	false	0	false	false	false				
2	2U	1336+44.302	1341+64.474	520.17	0.098	2010-2014: 1,800	12.00	12.00	8.00	8.00	0.00	0.3	1	false	0	false	false	false	2,864.79	2.0	true	60
3	2U	1341+64.474	1345+88.891	424.42	0.080	2010-2014: 1,800	12.00	12.00	8.00	8.00	6.00	0.3	1	false	0	false	false	false	2,864.79	2.0	true	60
4	2U	1345+88.891	1349+42.437	353.55	0.067	2010-2014: 1,800	12.00	12.00	8.00	8.00	6.00	0.3	1	false	0	false	false	false				
5	2U	1349+42.437	1350+43.605	101.17	0.019	2010-2014: 1,800	12.00	12.00	8.00	8.00	0.00	0.3	1	false	0	false	false	false				
6	2U	1350+43.605	1355+75.006	531.40	0.100	2010-2014: 1,800	12.00	12.00	8.00	8.00	0.00	0.3	1	false	0	false	false	false	1,432.40	2.0	true	60
7	2U	1355+75.006	1359+98.149	423.14	0.080	2010-2014: 1,800	12.00	12.00	8.00	8.00	0.00	0.3	1	false	0	false	false	false				
8	2U	1359+98.149	1361+84.449	186.30	0.035	2010-2014: 1,800	12.00	12.00	8.00	8.00	0.00	0.3	1	false	0	false	false	false	2,864.79	2.0	true	60
9	2U	1361+84.449	1372+13.914	1,029.46	0.195	2010-2014: 1,800	12.00	12.00	8.00	8.00	2.77	0.3	1	false	0	false	false	false	2,864.79	2.0	true	60
10	2U	1372+13.914	1375+23.561	309.65	0.058	2010-2014: 1,800	12.00	12.00	8.00	8.00	3.10	0.3	1	false	0	false	false	false	2,864.79	2.0	true	60
11	2U	1375+23.561	1403+14.142	2,790.58	0.528	2010-2014: 1,800	12.00	12.00	8.00	8.00	3.10	0.3	1	false	0	false	false	false				
12	2U	1403+14.142	1409+56.099	641.96	0.121	2010-2014: 1,800	12.00	12.00	8.00	8.00	4.20	0.3	1	false	0	false	false	false				
13	2U	1409+56.099	1413+11.581	355.48	0.067	2010-2014: 1,800	12.00	12.00	8.00	8.00	4.20	0.3	1	false	0	false	false	false	1,909.86	2.0	true	60
14	2U	1413+11.581	1420+94.274	782.69	0.148	2010-2014: 1,800	12.00	12.00	8.00	8.00	4.57	0.3	1	false	0	false	false	false	1,909.86	2.0	true	60
15	2U	1420+94.274	1425+01.019	406.75	0.077	2010-2014: 1,800	12.00	12.00	8.00	8.00	4.57	0.3	1	false	0	false	false	false				
16	2U	1425+01.019	1429+54.331	453.31	0.085	2010-2014: 1,800	12.00	12.00	8.00	8.00	0.50	0.3	1	false	0	false	false	false				
17	2U	1429+54.331	1434+88.047	533.72	0.101	2010-2014: 1,800	12.00	12.00	8.00	8.00	0.50	0.3	1	false	0	false	false	false	1,909.86	2.0	true	60
18	2U	1434+88.047	1439+38.259	450.21	0.085	2010-2014: 1,800	12.00	12.00	8.00	8.00	3.40	0.3	1	false	0	false	false	false	1,909.86	2.0	true	60
19	2U	1439+38.259	1442+00.000	261.74	0.049	2010-2014: 1,800	12.00	12.00	8.00	8.00	3.40	0.3	1	false	0	false	false	false				
20	2U	1442+00.000	1445+85.729	385.73	0.073	2010-2014: 1,800	12.00	12.00	8.00	8.00	3.40	0.3	1	false	1	false	false	false				
21	2U	1445+85.729	1454+00.000	814.27	0.154	2010-2014: 1,800	12.00	12.00	8.00	8.00	3.50	0.3	1	false	1	false	false	false				
22	2U	1454+00.000	1457+87.869	387.87	0.073	2010-2014: 1,800	12.00	12.00	8.00	8.00	3.50	0.3	1	false	0	false	false	false				
23	2U	1457+87.869	1463+32.941	545.07	0.103	2010-2014: 1,800	12.00	12.00	8.00	8.00	3.50	0.3	1	false	0	false	false	false	2,864.79	2.0	true	60
24	2U	1463+32.941	1468+59.089	526.15	0.099	2010-2014: 1,800	12.00	12.00	8.00	8.00	3.50	0.3	1	false	0	false	false	false				
25	2U	1468+59.089	1473+71.093	512.00	0.097	2010-2014: 1,800	12.00	12.00	8.00	8.00	3.50	0.3	1	false	0	false	false	false	1,950.00	2.0	true	60
26	2U	1473+71.093	1477+61.956	390.86	0.074	2010-2014: 1,800	12.00	12.00	8.00	8.00	0.30	0.3	1	false	0	false	false	false	1,950.00	2.0	true	60
27	2U	1477+61.956	1482+39.570	477.61	0.090	2010-2014: 1,800	12.00	12.00	8.00	8.00	0.30	0.3	1	false	0	false	false	false				
28	2U	1482+39.570	1490+31.091	791.52	0.149	2010-2014: 1,800	12.00	12.00	8.00	8.00	0.60	0.3	1	false	0	false	false	false				
29	2U	1490+31.091	1502+99.266	1,268.17	0.240	2010-2014: 1,800	12.00	12.00	8.00	8.00	0.60	0.3	1	false	0	false	false	false	1,155.00	2.0	true	60
30	2U	1502+99.266	1506+85.128	385.86	0.073	2010-2014: 1,800	12.00	12.00	8.00	8.00	4.20	0.3	1	false	0	false	false	false	1,155.00	2.0	true	60
31	2U	1506+85.128	1511+36.056	450.93	0.085	2010-2014: 1,800	12.00	12.00	8.00	8.00	4.20	0.3	1	false	0	false	false	false				
32	2U	1511+36.056	1518+02.293	666.24	0.126	2010-2014: 1,800	12.00	12.00	8.00	8.00	4.20	0.3	1	false	0	false	false	false	1,145.92	2.0	true	60
33	2U	1518+02.293	1522+56.443	454.15	0.086	2010-2014: 1,800	12.00	12.00	8.00	8.00	4.20	0.3	1	false	0	false	false	false				
34	2U	1522+56.443	1530+56.765	800.32	0.151	2010-2014: 1,800	12.00	12.00	8.00	8.00	2.40	0.3	1	false	0	false	false	false				

Seg. No.	Type	Start Location	End Location	Length (ft)	Length (mi)	AADT	Left Lane Width (ft)	Right Lane Width (ft)	Left Shoulder Width (ft)	Right Shoulder Width (ft)	Grade (%)	Driveway Density (driveways/mi)	Hazard Rating	Centerline Rumble Strip	Passing Lanes	TW LT Lane	Lighting	Automated Speed Enforcement	Radius (ft)	Superelevation (%)	Adverse	Design Speed (mph)
35	2U	1530+56.765	1532+29.037	172.27	0.0326	2010-2014: 1,800	12.00	12.00	8.00	8.00	2.40	0.3	1	false	0	false	false	false	1,440.0	2.0	true	60
36	2U	1532+29.037	1546+35.066	1,406.03	0.2663	2010-2014: 1,800	12.00	12.00	8.00	8.00	1.55	0.3	1	false	0	false	false	false	1,440.0	2.0	true	60
37	2U	1546+35.066	1555+00.000	864.93	0.1638	2010-2014: 1,800	12.00	12.00	8.00	8.00	1.55	0.3	1	false	0	false	false	false				
38	2U	1555+00.000	1555+42.935	42.94	0.0081	2010-2014: 1,800	12.00	12.00	8.00	8.00	1.55	0.3	1	false	1	false	false	false				
39	2U	1555+42.935	1561+65.077	622.14	0.1178	2010-2014: 1,800	12.00	12.00	8.00	8.00	2.00	0.3	1	false	1	false	false	false				
40	2U	1561+65.077	1568+88.080	723.00	0.1369	2010-2014: 1,800	12.00	12.00	8.00	8.00	2.00	0.3	1	false	1	false	false	false	1,152.0	2.0	true	60
41	2U	1568+88.080	1575+49.666	661.59	0.1253	2010-2014: 1,800	12.00	12.00	8.00	8.00	7.00	0.3	1	false	1	false	false	false	1,152.0	2.0	true	60
42	2U	1575+49.666	1579+81.473	431.81	0.0818	2010-2014: 1,800	12.00	12.00	8.00	8.00	7.00	0.3	1	false	1	false	false	false				
43	2U	1579+81.473	1587+62.614	781.14	0.1479	2010-2014: 1,800	12.00	12.00	8.00	8.00	7.00	0.3	1	false	1	false	false	false	881.47	2.0	true	60
44	2U	1587+62.614	1589+20.405	157.79	0.0299	2010-2014: 1,800	12.00	12.00	8.00	8.00	7.00	0.3	1	false	1	false	false	false				
45	2U	1589+20.405	1591+85.378	264.97	0.0502	2010-2014: 1,800	12.00	12.00	8.00	8.00	3.90	0.3	1	false	1	false	false	false				
46	2U	1591+85.378	1598+89.259	703.88	0.1333	2010-2014: 1,800	12.00	12.00	8.00	8.00	3.90	0.3	1	false	1	false	false	false	825.00	2.0	true	60
47	2U	1598+89.259	1604+98.065	608.81	0.1153	2010-2014: 1,800	12.00	12.00	8.00	8.00	7.00	0.3	1	false	1	false	false	false	825.00	2.0	true	60
48	2U	1604+98.065	1609+35.192	437.13	0.0828	2010-2014: 1,800	12.00	12.00	8.00	8.00	7.00	0.3	1	false	1	false	false	false				
49	2U	1609+35.192	1610+00.000	64.81	0.0123	2010-2014: 1,800	12.00	12.00	8.00	8.00	7.00	0.3	1	false	1	false	false	false	1,041.74	2.0	true	60
50	2U	1610+00.000	1614+65.403	465.40	0.0881	2010-2014: 1,800	12.00	12.00	8.00	8.00	7.00	0.3	1	false	0	false	false	false	1,041.74	2.0	true	60
51	2U	1614+65.403	1615+65.837	100.43	0.0190	2010-2014: 1,800	12.00	12.00	8.00	8.00	7.00	0.3	1	false	0	false	false	false				
52	2U	1615+65.837	1623+55.342	789.50	0.1495	2010-2014: 1,800	12.00	12.00	8.00	8.00	0.70	0.3	1	false	0	false	false	false				
53	2U	1623+55.342	1627+06.536	351.19	0.0665	2010-2014: 1,800	12.00	12.00	8.00	8.00	0.70	0.3	1	false	0	false	false	false	3,819.72	2.0	true	60
54	2U	1627+06.536	1634+67.324	760.79	0.1441	2010-2014: 1,800	12.00	12.00	8.00	8.00	3.30	0.3	1	false	0	false	false	false	3,819.72	2.0	true	60
55	2U	1634+67.324	1643+43.433	876.11	0.1659	2010-2014: 1,800	12.00	12.00	8.00	8.00	3.30	0.3	1	false	0	false	false	false				
56	2U	1643+43.433	1658+40.396	1,496.96	0.2835	2010-2014: 1,800	12.00	12.00	8.00	8.00	3.30	0.3	1	false	0	false	false	false	2,546.48	2.0	true	60
57	2U	1658+40.396	1662+05.617	365.22	0.0692	2010-2014: 1,800	12.00	12.00	8.00	8.00	0.70	0.3	1	false	0	false	false	false	2,546.48	2.0	true	60
58	2U	1662+05.617	1671+65.038	959.42	0.1817	2010-2014: 1,800	12.00	12.00	8.00	8.00	0.70	0.3	1	false	0	false	false	false				
59	2U	1671+65.038	1674+56.874	291.84	0.0553	2010-2014: 1,800	12.00	12.00	8.00	8.00	1.30	0.3	1	false	0	false	false	false				
60	2U	1674+56.874	1681+00.000	643.13	0.1218	2010-2014: 1,800	12.00	12.00	8.00	8.00	1.30	0.3	1	false	0	false	false	false	2,864.79	2.0	true	60



Seg. No.	Type	Start Location	End Location	Length (ft)	Length (mi)	AADT	Left Lane Width (ft)	Right Lane Width (ft)	Left Shoulder Width (ft)	Right Shoulder Width (ft)	Grade (%)	Driveway Density (driveways/mi)	Hazard Rating	Centerline Rumble Strip	Passing Lanes	TW LT Lane	Lighting	Automated Speed Enforcement	Radius (ft)	Superelevation (%)	Adverse	Design Speed (mph)
61	2U	1681+00.00	1684+84.121	384.12	0.0727	2010-2014: 1,800	12.00	12.00	8.00	8.00	1.30	0.3	1	false	1	false	false	false	2,864.79	2.0	true	60
62	2U	1684+84.121	1689+55.548	471.43	0.0893	2010-2014: 1,800	12.00	12.00	8.00	8.00	1.30	0.3	1	false	1	false	false	false				
63	2U	1689+55.548	1696+91.231	735.68	0.1393	2010-2014: 1,800	12.00	12.00	8.00	8.00	1.30	0.3	1	false	1	false	false	false	2,291.83	2.0	true	60
64	2U	1696+91.231	1697+38.184	46.95	0.0089	2010-2014: 1,800	12.00	12.00	8.00	8.00	0.60	0.3	1	false	1	false	false	false	2,291.83	2.0	true	60
65	2U	1697+38.184	1703+52.875	614.69	0.1164	2010-2014: 1,800	12.00	12.00	8.00	8.00	0.60	0.3	1	false	1	false	false	false				
66	2U	1703+52.875	1708+54.649	501.77	0.0950	2010-2014: 1,800	12.00	12.00	8.00	8.00	0.60	0.3	1	false	1	false	false	false	3,819.72	2.0	true	60
67	2U	1708+54.649	1713+92.335	537.69	0.1018	2010-2014: 1,800	12.00	12.00	8.00	8.00	4.00	0.3	1	false	1	false	false	false	3,819.72	2.0	true	60
68	2U	1713+92.335	1716+89.463	297.13	0.0563	2010-2014: 1,800	12.00	12.00	8.00	8.00	4.00	0.3	1	false	1	false	false	false				
69	2U	1716+89.463	1728+08.381	1,118.9	0.2119	2010-2014: 1,800	12.00	12.00	8.00	8.00	0.50	0.3	1	false	1	false	false	false				
70	2U	1728+08.381	1731+17.025	308.64	0.0585	2010-2014: 1,800	12.00	12.00	8.00	8.00	5.30	0.3	1	false	1	false	false	false				
71	2U	1731+17.025	1736+82.212	565.19	0.1070	2010-2014: 1,800	12.00	12.00	8.00	8.00	5.30	0.3	1	false	1	false	false	false	2,150.00	2.0	true	60
72	2U	1736+82.212	1739+00.000	217.79	0.0413	2010-2014: 1,800	12.00	12.00	8.00	8.00	5.30	0.3	1	false	1	false	false	false				
73	2U	1739+00.000	1749+79.705	1,079.70	0.2045	2010-2014: 1,800	12.00	12.00	8.00	8.00	5.30	0.3	1	false	0	false	false	false				
74	2U	1749+79.705	1750+54.678	74.97	0.0142	2010-2014: 1,800	12.00	12.00	8.00	8.00	5.30	0.3	1	false	0	false	false	false	1,950.00	2.0	true	60
75	2U	1750+54.678	1754+00.000	345.32	0.0654	2010-2014: 1,800	12.00	12.00	8.00	8.00	4.60	0.3	1	false	0	false	false	false	1,950.00	2.0	true	60
76	2U	1754+00.000	1756+47.361	247.36	0.0469	2010-2014: 1,800	12.00	12.00	8.00	8.00	4.60	0.3	1	false	1	false	false	false	1,950.00	2.0	true	60
77	2U	1756+47.361	1761+94.171	546.81	0.1036	2010-2014: 1,800	12.00	12.00	8.00	8.00	4.60	0.3	1	false	1	false	false	false				
78	2U	1761+94.171	1764+68.438	274.27	0.0519	2010-2014: 1,800	12.00	12.00	8.00	8.00	4.60	0.3	1	false	1	false	false	false	5,800.00	2.0	true	60
79	2U	1764+68.438	1769+37.986	469.55	0.0889	2010-2014: 1,800	12.00	12.00	8.00	8.00	5.00	0.3	1	false	1	false	false	false	5,800.00	2.0	true	60
80	2U	1769+37.986	1786+03.032	1,665.05	0.3154	2010-2014: 1,800	12.00	12.00	8.00	8.00	5.00	0.3	1	false	1	false	false	false				
81	2U	1786+03.032	1796+26.415	1,023.38	0.1938	2010-2014: 1,800	12.00	12.00	8.00	8.00	0.30	0.3	1	false	1	false	false	false				
82	2U	1796+26.415	1801+11.457	485.04	0.0919	2010-2014: 1,800	12.00	12.00	8.00	8.00	0.30	0.3	1	false	1	false	false	false	5,729.58	2.0	true	60
83	2U	1801+11.457	1803+66.390	254.93	0.0483	2010-2014: 1,800	12.00	12.00	8.00	8.00	0.30	0.3	1	false	1	false	false	false				
84	2U	1803+66.390	1814+09.517	1,043.13	0.1976	2010-2014: 1,800	12.00	12.00	8.00	8.00	4.90	0.3	1	false	1	false	false	false				
85	2U	1814+09.517	1819+97.464	587.95	0.1114	2010-2014: 1,800	12.00	12.00	8.00	8.00	4.90	0.3	1	false	1	false	false	false	1,450.00	2.0	true	60
86	2U	1819+97.464	1820+48.062	50.60	0.0096	2010-2014: 1,800	12.00	12.00	8.00	8.00	4.90	0.3	1	false	1	false	false	false				

Seg. No.	Type	Start Location	End Location	Length (ft)	Length (mi)	AADT	Left Lane Width (ft)	Right Lane Width (ft)	Left Shoulder Width (ft)	Right Shoulder Width (ft)	Grade (%)	Driveway Density (driveways/mi)	Hazard Rating	Centerline Rumble Strip	Passing Lanes	TW LT Lane	Lighting	Automated Speed Enforcement	Radius (ft)	Superelevation (%)	Adverse	Design Speed (mph)
87	2U	1820+48.062	1824+53.898	405.84	0.0769	2010-2014: 1,800	12.00	12.00	8.00	8.00	1.70	0.3	1	false	1	false	false	false				
88	2U	1824+53.898	1826+89.465	235.57	0.0446	2010-2014: 1,800	12.00	12.00	8.00	8.00	1.70	0.3	1	false	1	false	false	false	3,000.00	2.0	true	60
89	2U	1826+89.465	1830+41.880	352.42	0.0668	2010-2014: 1,800	12.00	12.00	8.00	8.00	5.00	0.3	1	false	1	false	false	false	3,000.00	2.0	true	60
90	2U	1830+41.880	1836+58.064	616.18	0.1167	2010-2014: 1,800	12.00	12.00	8.00	8.00	5.00	0.3	1	false	1	false	false	false				
91	2U	1836+58.064	1841+90.386	532.32	0.1008	2010-2014: 1,800	12.00	12.00	8.00	8.00	5.00	0.3	1	false	1	false	false	false	1,160.00	2.0	true	60
92	2U	1841+90.386	1844+74.496	284.11	0.0538	2010-2014: 1,800	12.00	12.00	8.00	8.00	4.00	0.3	1	false	1	false	false	false	1,160.00	2.0	true	60
93	2U	1844+74.496	1849+15.104	440.61	0.0834	2010-2014: 1,800	12.00	12.00	8.00	8.00	4.00	0.3	1	false	1	false	false	false				
94	2U	1849+15.104	1858+04.945	889.84	0.1685	2010-2014: 1,800	12.00	12.00	8.00	8.00	4.00	0.3	1	false	1	false	false	false	825.00	2.0	true	60
95	2U	1858+04.945	1869+49.895	1,144.95	0.2168	2010-2014: 1,800	12.00	12.00	8.00	8.00	4.00	0.3	1	false	1	false	false	false				
96	2U	1869+49.895	1875+20.742	570.85	0.1081	2010-2014: 1,800	12.00	12.00	8.00	8.00	4.00	0.3	1	false	1	false	false	false	1,909.86	2.0	true	60
97	2U	1875+20.742	1887+50.279	1,229.54	0.2329	2010-2014: 1,800	12.00	12.00	8.00	8.00	4.00	0.3	1	false	1	false	false	false				
98	2U	1887+50.279	1899+00.000	1,149.72	0.2177	2010-2014: 1,800	12.00	12.00	8.00	8.00	3.20	0.3	1	false	1	false	false	false				
99	2U	1899+00.000	1902+52.815	352.81	0.0668	2010-2014: 1,800	12.00	12.00	8.00	8.00	3.20	0.3	1	false	0	false	false	false				
100	2U	1902+52.815	1908+15.543	562.73	0.1066	2010-2014: 1,800	12.00	12.00	8.00	8.00	3.20	0.3	1	false	0	false	false	false	1,980.00	2.0	true	60
101	2U	1908+15.543	1912+56.122	440.58	0.0834	2010-2014: 1,800	12.00	12.00	8.00	8.00	3.20	0.3	1	false	0	false	false	false				
102	2U	1912+56.122	1922+09.301	953.18	0.1805	2010-2014: 1,800	12.00	12.00	8.00	8.00	3.20	0.3	1	false	0	false	false	false	1,909.86	2.0	true	60
103	2U	1922+09.301	1923+07.672	98.37	0.0186	2010-2014: 1,800	12.00	12.00	8.00	8.00	0.16	0.3	1	false	0	false	false	false	1,909.86	2.0	true	60
104	2U	1923+07.672	1942+90.110	1,982.44	0.3755	2010-2014: 1,800	12.00	12.00	8.00	8.00	0.16	0.3	1	false	0	false	false	false				
105	2U	1942+90.110	1951+68.332	878.22	0.1663	2010-2014: 1,800	12.00	12.00	8.00	8.00	4.20	0.3	1	false	0	false	false	false				
106	2U	1951+68.332	1991+05.968	3,937.64	0.7458	2010-2014: 1,800	12.00	12.00	8.00	8.00	1.30	0.3	1	false	0	false	false	false				
107	2U	1991+05.968	2014+85.473	2,379.51	0.4507	2010-2014: 1,800	12.00	12.00	8.00	8.00	5.00	0.3	1	false	0	false	false	false				
108	2U	2014+85.473	2044+63.612	2,978.14	0.5640	2010-2014: 1,800	12.00	12.00	8.00	8.00	5.00	0.3	1	false	0	false	false	false				
109	2U	2044+63.612	2061+78.629	1,715.02	0.3248	2010-2014: 1,800	12.00	12.00	8.00	8.00	0.30	0.3	1	false	0	false	false	false				
110	2U	2061+78.629	2070+98.406	919.78	0.1742	2010-2014: 1,800	12.00	12.00	8.00	8.00	0.80	0.3	1	false	0	false	false	false				
111	2U	2070+98.406	2084+39.972	1,341.57	0.2541	2010-2014: 1,800	12.00	12.00	8.00	8.00	0.80	0.3	1	false	0	false	false	false	5,729.58	2.0	true	60
112	2U	2084+39.972	2086+40.102	200.13	0.0379	2010-2014: 1,800	12.00	12.00	8.00	8.00	2.00	0.3	1	false	0	false	false	false	5,729.58	2.0	true	60

Seg. No.	Type	Start Location	End Location	Length (ft)	Length (mi)	AADT	Left Lane Width (ft)	Right Lane Width (ft)	Left Shoulder Width (ft)	Right Shoulder Width (ft)	Grade (%)	Driveway Density (driveways/mi)	Hazard Rating	Centerline Rumble Strip	Passing Lanes	TW LT Lane	Lighting	Automated Speed Enforcement	Radius (ft)	Superelevation (%)	Adverse	Design Speed (mph)
113	2U	2086+40.102	2099+74.790	1,334.69	0.2528	2010-2014: 1,800	12.00	12.00	8.00	8.00	2.00	0.3	1	false	0	false	false	false				
114	2U	2099+74.790	2111+43.919	1,169.13	0.2214	2010-2014: 1,800	12.00	12.00	8.00	8.00	1.40	0.3	1	false	0	false	false	false				
115	2U	2111+43.919	2120+81.651	937.73	0.1776	2010-2014: 1,800	12.00	12.00	8.00	8.00	0.40	0.3	1	false	0	false	false	false				
116	2U	2120+81.651	2129+87.830	906.18	0.1716	2010-2014: 1,800	12.00	12.00	8.00	8.00	2.30	0.3	1	false	0	false	false	false				
117	2U	2129+87.830	2140+56.643	1,068.81	0.2024	2010-2014: 1,800	12.00	12.00	8.00	8.00	0.38	0.3	1	false	0	false	false	false				
118	2U	2140+56.643	2142+74.256	217.61	0.0412	2010-2014: 1,800	12.00	12.00	8.00	8.00	0.38	0.3	1	false	0	false	false	false	5,729.58	2.0	true	60
119	2U	2142+74.256	2168+08.627	2,534.37	0.4800	2010-2014: 1,800	12.00	12.00	8.00	8.00	2.00	0.3	1	false	0	false	false	false	5,729.58	2.0	true	60
120	2U	2168+08.627	2182+78.204	1,469.58	0.2783	2010-2014: 1,800	12.00	12.00	8.00	8.00	2.30	0.3	1	false	0	false	false	false	5,729.58	2.0	true	60
121	2U	2182+78.204	2183+26.113	47.91	0.0091	2010-2014: 1,800	12.00	12.00	8.00	8.00	3.00	0.3	1	false	0	false	false	false	5,729.58	2.0	true	60
122	2U	2183+26.113	2199+41.672	1,615.56	0.3060	2010-2014: 1,800	12.00	12.00	8.00	8.00	3.00	0.3	1	false	0	false	false	false				
123	2U	2199+41.672	2201+13.109	171.44	0.0325	2010-2014: 1,800	12.00	12.00	8.00	8.00	1.90	0.3	1	false	0	false	false	false				
124	2U	2201+13.109	2210+46.999	933.89	0.1769	2010-2014: 1,800	12.00	12.00	8.00	8.00	1.90	0.3	1	false	0	false	false	false	2,864.79	2.0	true	60
125	2U	2210+46.999	2224+50.778	1,403.78	0.2659	2010-2014: 1,800	12.00	12.00	8.00	8.00	1.90	0.3	1	false	0	false	false	false				
126	2U	2224+50.778	2238+41.687	1,390.91	0.2634	2010-2014: 1,800	12.00	12.00	8.00	8.00	0.50	0.3	1	false	0	false	false	false				
127	2U	2238+41.687	2252+38.958	1,397.27	0.2646	2010-2014: 1,800	12.00	12.00	8.00	8.00	2.50	0.3	1	false	0	false	false	false				
128	2U	2252+38.958	2253+13.131	74.17	0.0140	2010-2014: 1,800	12.00	12.00	8.00	8.00	2.50	0.3	1	false	0	false	false	false	2,788.71	2.0	true	60
129	2U	2253+13.131	2267+68.359	1,455.23	0.2756	2010-2014: 1,800	12.00	12.00	8.00	8.00	1.70	0.3	1	false	0	false	false	false	2,788.71	2.0	true	60
130	2U	2267+68.359	2271+18.026	349.67	0.0662	2010-2014: 1,800	12.00	12.00	8.00	8.00	1.70	0.3	1	false	0	false	false	false				
131	2U	2271+18.026	2275+17.825	399.80	0.0757	2010-2014: 1,800	12.00	12.00	8.00	8.00	3.50	0.3	1	false	0	false	false	false				
132	2U	2275+17.825	2283+86.397	868.57	0.1645	2010-2014: 1,800	12.00	12.00	8.00	8.00	3.50	0.3	1	false	0	false	false	false	2,788.71	2.0	true	60
133	2U	2283+86.397	2294+34.169	1,047.77	0.1984	2010-2014: 1,800	12.00	12.00	8.00	8.00	0.60	0.3	1	false	0	false	false	false	2,788.71	2.0	true	60
134	2U	2294+34.169	2297+86.147	351.98	0.0667	2010-2014: 1,800	12.00	12.00	8.00	8.00	0.00	0.3	1	false	0	false	false	false	2,788.71	2.0	true	60
135	2U	2297+86.147	2322+20.021	2,433.87	0.4610	2010-2014: 1,800	12.00	12.00	8.00	8.00	0.00	0.3	1	false	0	false	false	false				
136	2U	2322+20.021	2324+46.955	226.93	0.0430	2010-2014: 1,800	12.00	12.00	8.00	8.00	0.50	0.3	1	false	0	false	false	false				
137	2U	2324+46.955	2328+02.518	355.56	0.0673	2010-2014: 1,800	12.00	12.00	8.00	8.00	0.50	0.3	1	false	0	false	false	false	2,864.09	2.0	true	60
138	2U	2328+02.518	2335+97.505	794.99	0.1506	2010-2014: 1,800	12.00	12.00	8.00	8.00	0.00	0.3	1	false	0	false	false	false	2,864.09	2.0	true	60

Seg. No.	Type	Start Location	End Location	Length (ft)	Length (mi)	AADT	Left Lane Width (ft)	Right Lane Width (ft)	Left Shoulder Width (ft)	Right Shoulder Width (ft)	Grade (%)	Driveway Density (driveways/mi)	Hazard Rating	Centerline Rumble Strip	Passing Lanes	TW LT Lane	Lighting	Automated Speed Enforcement	Radius (ft)	Superelevation (%)	Adverse	Design Speed (mph)
139	2U	2335+97.505	2358+28.150	2,230.64	0.4225	2010-2014: 1,800	12.00	12.00	8.00	8.00	0.00	0.3	1	false	0	false	false	false				
140	2U	2358+28.150	2388+01.647	2,973.50	0.5632	2010-2014: 1,800	12.00	12.00	8.00	8.00	0.14	0.3	1	false	0	false	false	false				
141	2U	2388+01.647	2392+62.777	461.13	0.0873	2010-2014: 1,800	12.00	12.00	8.00	8.00	0.14	0.3	1	false	0	false	false	false	1,909.86	2.0	true	60
142	2U	2392+62.777	2393+97.841	135.06	0.0256	2010-2014: 1,800	12.00	12.00	8.00	8.00	1.70	0.3	1	false	0	false	false	false	1,909.86	2.0	true	60
143	2U	2393+97.841	2399+08.519	510.68	0.0967	2010-2014: 1,800	12.00	12.00	8.00	8.00	1.70	0.3	1	false	0	false	false	false				
144	2U	2399+08.519	2406+75.288	766.77	0.1452	2010-2014: 1,800	12.00	12.00	8.00	8.00	1.70	0.3	1	false	0	false	false	false	1,145.92	2.0	true	60
145	2U	2406+75.288	2410+56.262	380.97	0.0722	2010-2014: 1,800	12.00	12.00	8.00	8.00	0.20	0.3	1	false	0	false	false	false	1,145.92	2.0	true	60
146	2U	2410+56.262	2413+31.488	275.23	0.0521	2010-2014: 1,800	12.00	12.00	8.00	8.00	0.20	0.3	1	false	0	false	false	false				
147	2U	2413+31.488	2415+67.769	236.28	0.0447	2010-2014: 1,800	12.00	12.00	8.00	8.00	1.00	0.3	1	false	0	false	false	false				
148	2U	2415+67.769	2417+66.491	198.72	0.0376	2010-2014: 1,800	12.00	12.00	8.00	8.00	1.00	0.3	1	false	0	false	false	false	1,145.91	2.0	true	60
149	2U	2417+66.491	2419+57.000	190.51	0.0361	2010-2014: 1,800	12.00	12.00	8.00	8.00	0.00	0.3	1	false	0	false	false	false	1,145.91	2.0	true	60
150	2U	2419+57.000	2424+37.323	480.32	0.0910	2010-2014: 1,800	12.00	12.00	8.00	8.00	0.00	0.3	1	false	0	false	false	false	1,145.91	2.0	true	60

**Table 4. Expected Highway Crash Rates and Frequencies (Section 1)**

<b>First Year of Analysis</b>	2017
<b>Last Year of Analysis</b>	2017
<b>Evaluated Length (mi)</b>	20.7820
<b>Average Future Road AADT (vpd)</b>	1,800
<b>Expected Crashes</b>	
<b>Total Crashes</b>	7.85
<b>Fatal and Injury Crashes</b>	2.69
<b>Property-Damage-Only Crashes</b>	5.16
<b>Percent of Total Expected Crashes</b>	
<b>Percent Fatal and Injury Crashes (%)</b>	34
<b>Percent Property-Damage-Only Crashes (%)</b>	66
<b>Expected Crash Rate</b>	
<b>Crash Rate (crashes/mi/yr)</b>	0.3779
<b>Fatal and Injury Crash Rate (crashes/mi/yr)</b>	0.1296
<b>Property-Damage-Only Crash Rate (crashes/mi/yr)</b>	0.2483
<b>Expected Travel Crash Rate</b>	
<b>Total Travel (million veh-mi)</b>	13.65
<b>Travel Crash Rate (crashes/million veh-mi)</b>	0.57
<b>Travel Fatal and Injury Crash Rate (crashes/million veh-mi)</b>	0.20
<b>Travel Property-Damage-Only Crash Rate (crashes/million veh-mi)</b>	0.38

**Table 5. Expected Crash Frequencies and Rates by Highway Segment (Section 1)**

Segment Number/Intersection Name/Cross Road	Start Location	End Location	Length (mi)	Expected No. Crashes for Evaluation Period	Crash Rate (crashes/mi/yr)	Travel Crash Rate (crashes/million veh-mi)
1	1327+09.000	1336+44.302	0.1771	0.048	0.2683	0.41
2	1336+44.302	1345+88.891	0.1789	0.058	0.3241	0.49
3	1345+88.891	1350+43.605	0.0861	0.023	0.2619	0.40
4	1350+43.605	1355+75.006	0.1006	0.037	0.3717	0.57
5	1355+75.006	1359+98.149	0.0801	0.021	0.2683	0.41
6	1359+98.149	1375+23.561	0.2889	0.092	0.3200	0.49
7	1375+23.561	1393+00.000	0.3364	0.087	0.2601	0.40
8	1393+00.000	1400+30.565	0.1384	0.036	0.2601	0.40
9	1400+30.565	1409+13.059	0.1671	0.043	0.2601	0.40
10	1409+13.059	1414+04.404	0.0931	0.030	0.3205	0.49
11	1414+04.404	1421+34.750	0.1383	0.049	0.3509	0.53

Segment Number/Intersection Name/Cross Road	Start Location	End Location	Length (mi)	Expected No. Crashes for Evaluation Period	Crash Rate (crashes/mi/yr)	Travel Crash Rate (crashes/million veh-mi)
12	1421+34.750	1429+14.713	0.1477	0.043	0.2909	0.44
13	1429+14.713	1429+71.777	0.0108	0.004	0.3985	0.61
14	1429+71.777	1439+70.699	0.1892	0.062	0.3273	0.50
15	1439+70.699	1446+51.376	0.1289	0.036	0.2760	0.42
16	1446+51.376	1449+40.000	0.0547	0.017	0.3125	0.48
17	1449+40.000	1451+33.375	0.0366	0.009	0.2344	0.36
18	1451+33.375	1461+98.062	0.2016	0.051	0.2525	0.38
19	1461+98.062	1467+73.811	0.1090	0.023	0.2085	0.32
20	1467+73.811	1475+38.715	0.1449	0.038	0.2611	0.40
21	1475+38.715	1478+43.352	0.0577	0.025	0.4375	0.67
22	1478+43.352	1483+12.985	0.0889	0.057	0.6452	0.98
23	1483+12.985	1497+77.648	0.2774	0.069	0.2490	0.38
24	1497+77.648	1505+09.701	0.1386	0.035	0.2544	0.39
25	1505+09.701	1507+88.933	0.0529	0.011	0.1979	0.30
26	1507+88.933	1518+44.144	0.1999	0.106	0.5297	0.81
27	1518+44.144	1523+30.687	0.0921	0.066	0.7155	1.09
28	1523+30.687	1523+64.397	0.0064	0.001	0.2214	0.34
29	1523+64.397	1548+64.398	0.4735	0.126	0.2654	0.40
30	1548+64.398	1551+09.491	0.0464	0.010	0.2214	0.34
31	1551+09.491	1556+63.827	0.1050	0.024	0.2270	0.34
32	1556+63.827	1570+18.580	0.2566	0.078	0.3045	0.46
33	1570+18.580	1581+42.155	0.2128	0.054	0.2559	0.39
34	1581+42.155	1600+40.495	0.3595	0.145	0.4036	0.61
35	1600+40.495	1602+30.336	0.0360	0.007	0.1992	0.30
36	1602+30.336	1615+87.225	0.2570	0.064	0.2469	0.38
37	1615+87.225	1621+46.738	0.1060	0.029	0.2771	0.42
38	1621+46.738	1625+91.000	0.0841	0.018	0.2128	0.32
39	1625+91.000	1633+46.402	0.1431	0.090	0.6310	0.96
40	1633+46.402	1649+14.793	0.2970	0.239	0.8035	1.22
41	1649+14.793	1652+11.160	0.0561	0.032	0.5694	0.87
42	1652+11.160	1661+79.000	0.1833	0.068	0.3703	0.56
43	1661+79.000	1664+36.565	0.0488	0.008	0.1729	0.26
44	1664+36.565	1675+12.295	0.2037	0.110	0.5394	0.82
45	1675+12.295	1678+20.135	0.0583	0.045	0.7745	1.18
46	1678+20.135	1688+79.987	0.2007	0.090	0.4491	0.68
47	1688+79.987	1693+40.960	0.0873	0.079	0.9023	1.37
48	1693+40.960	1695+70.734	0.0435	0.058	1.3330	2.03
49	1695+70.734	1704+03.820	0.1578	0.138	0.8737	1.33
50	1704+03.820	1706+93.795	0.0549	0.037	0.6810	1.04
51	1706+93.795	1718+16.939	0.2127	0.051	0.2419	0.37
52	1718+16.939	1718+73.301	0.0107	0.002	0.2084	0.32
53	1718+73.301	1729+24.812	0.1991	0.053	0.2651	0.40
54	1729+24.812	1738+90.122	0.1828	0.035	0.1888	0.29
55	1738+90.122	1739+01.335	0.0021	0.001	0.2806	0.43
56	1739+01.335	1749+60.945	0.2007	0.097	0.4817	0.73
57	1749+60.945	1753+37.825	0.0714	0.011	0.1566	0.24
58	1753+37.825	1756+19.308	0.0533	0.010	0.1866	0.28
59	1756+19.308	1763+99.822	0.1478	0.035	0.2340	0.36
60	1763+99.822	1773+79.000	0.1855	0.036	0.1968	0.30
61	1773+79.000	1776+44.892	0.0504	0.016	0.3125	0.48
62	1776+44.892	1783+38.648	0.1314	0.037	0.2841	0.43

Segment Number/Intersection Name/Cross Road	Start Location	End Location	Length (mi)	Expected No. Crashes for Evaluation Period	Crash Rate (crashes/mi/yr)	Travel Crash Rate (crashes/million veh-mi)
63	1783+38.648	1793+15.024	0.1849	0.061	0.3325	0.51
64	1793+15.024	1793+95.145	0.0152	0.006	0.3683	0.56
65	1793+95.145	1806+14.814	0.2310	0.089	0.3868	0.59
66	1806+14.814	1806+82.524	0.0128	0.009	0.6858	1.04
67	1806+82.524	1818+59.631	0.2229	0.160	0.7194	1.09
68	1818+59.631	1819+02.306	0.0081	0.003	0.3637	0.55
69	1819+02.306	1837+08.045	0.3420	0.177	0.5179	0.79
70	1837+08.045	1837+12.472	0.0008	0.000	0.2682	0.41
71	1837+12.472	1852+14.359	0.2844	0.107	0.3779	0.57
72	1852+14.359	1855+90.269	0.0712	0.019	0.2617	0.40
73	1855+90.269	1866+66.290	0.2038	0.079	0.3897	0.59
74	1866+66.290	1872+40.458	0.1087	0.064	0.5920	0.90
75	1872+40.458	1884+00.000	0.2196	0.098	0.4468	0.68
76	1884+00.000	1887+17.885	0.0602	0.012	0.2031	0.31
77	1887+17.885	1897+69.447	0.1992	0.107	0.5364	0.82
78	1897+69.447	1900+15.731	0.0466	0.015	0.3126	0.48
79	1900+15.731	1911+44.501	0.2138	0.148	0.6919	1.05
80	1911+44.501	1914+69.648	0.0616	0.022	0.3536	0.54
81	1914+69.648	1935+13.440	0.3871	0.064	0.1643	0.25
82	1935+13.440	1942+14.172	0.1327	0.025	0.1919	0.29
83	1942+14.172	1979+48.414	0.7072	0.249	0.3528	0.54
84	1979+48.414	1990+96.000	0.2173	0.081	0.3740	0.57
85	1990+96.000	2004+08.375	0.2486	0.072	0.2885	0.44
86	2004+08.375	2032+26.622	0.5338	0.153	0.2861	0.43
87	2032+26.622	2059+91.129	0.5236	0.139	0.2647	0.40
88	2059+91.129	2073+83.086	0.2636	0.084	0.3179	0.48
89	2073+83.086	2075+32.995	0.0284	0.009	0.3042	0.46
90	2075+32.995	2088+98.505	0.2586	0.066	0.2566	0.39
91	2088+98.505	2107+64.701	0.3534	0.138	0.3893	0.59
92	2107+64.701	2118+80.968	0.2114	0.127	0.6009	0.92
93	2118+80.968	2127+46.000	0.1638	0.058	0.3514	0.54
94	2127+46.000	2129+49.536	0.0385	0.007	0.1744	0.27
95	2129+49.536	2132+09.424	0.0492	0.010	0.2049	0.31
96	2132+09.424	2156+63.518	0.4648	0.092	0.1986	0.30
97	2156+63.518	2172+19.006	0.2946	0.058	0.1953	0.30
98	2172+19.006	2172+26.614	0.0014	0.000	0.1662	0.25
99	2172+26.614	2188+12.331	0.3003	0.097	0.3215	0.49
100	2188+12.331	2189+34.430	0.0231	0.013	0.5780	0.88
101	2189+34.430	2200+10.193	0.2037	0.147	0.7237	1.10
102	2200+10.193	2212+68.167	0.2383	0.045	0.1896	0.29
103	2212+68.167	2227+11.813	0.2734	0.090	0.3295	0.50
104	2227+11.813	2230+62.000	0.0663	0.022	0.3307	0.50
105	2230+62.000	2241+30.583	0.2024	0.090	0.4439	0.68
106	2241+30.583	2242+42.790	0.0213	0.007	0.3506	0.53
107	2242+42.790	2256+59.979	0.2684	0.092	0.3423	0.52
108	2256+59.979	2259+05.408	0.0465	0.011	0.2469	0.38
109	2259+05.408	2264+09.452	0.0955	0.026	0.2716	0.41
110	2264+09.452	2272+06.202	0.1509	0.055	0.3632	0.55
111	2272+06.202	2286+77.767	0.2787	0.088	0.3150	0.48
112	2286+77.767	2313+38.578	0.5039	0.212	0.4204	0.64
113	2313+38.578	2324+89.129	0.2179	0.147	0.6770	1.03

Segment Number/Intersection Name/Cross Road	Start Location	End Location	Length (mi)	Expected No. Crashes for Evaluation Period	Crash Rate (crashes/mi/yr)	Travel Crash Rate (crashes/million veh-mi)
114	2324+89.129	2376+93.270	0.9856	0.448	0.4546	0.69
115	2376+93.270	2381+06.049	0.0782	0.059	0.7584	1.15
116	2381+06.049	2382+89.464	0.0347	0.026	0.7584	1.15
117	2382+89.464	2388+00.142	0.0967	0.048	0.4933	0.75
118	2388+00.142	2392+46.808	0.0846	0.108	1.2738	1.94
119	2392+46.808	2399+47.886	0.1328	0.054	0.4088	0.62
120	2399+47.886	2404+59.393	0.0969	0.022	0.2318	0.35
121	2404+59.393	2407+00.000	0.0456	0.016	0.3512	0.54
122	2407+00.000	2415+33.737	0.1579	0.060	0.3829	0.58
123	2415+33.737	2424+38.143	0.1713	0.149	0.8679	1.32

**Table 6. Expected Crash Frequencies and Rates by Horizontal Design Element (Section 1)**

Title	Start Location	End Location	Length (mi)	Expected No. Crashes for Evaluation Period	Crash Rate (crashes/mi/yr)	Travel Crash Rate (crashes/million veh-mi)
Tangent	1327+09.000	1336+44.302	0.1771	0.048	0.2683	0.41
Simple Curve 1	1336+44.302	1345+88.891	0.1789	0.058	0.3241	0.49
Tangent	1345+88.891	1350+43.605	0.0861	0.023	0.2619	0.40
Simple Curve 2	1350+43.605	1355+75.006	0.1006	0.037	0.3717	0.57
Tangent	1355+75.006	1359+98.149	0.0801	0.021	0.2683	0.41
Simple Curve 3	1359+98.149	1375+23.561	0.2889	0.092	0.3200	0.49
Tangent	1375+23.561	1409+13.059	0.6420	0.167	0.2601	0.40
Simple Curve 4	1409+13.059	1421+34.750	0.2314	0.078	0.3387	0.52
Tangent	1421+34.750	1429+14.713	0.1477	0.043	0.2909	0.44
Simple Curve 5	1429+14.713	1439+70.699	0.2000	0.066	0.3312	0.50
Tangent	1439+70.699	1451+33.375	0.2202	0.061	0.2781	0.42
Simple Curve 6	1451+33.375	1461+98.062	0.2016	0.051	0.2525	0.38
Tangent	1461+98.062	1467+73.811	0.1090	0.023	0.2085	0.32
Simple Curve 7	1467+73.811	1478+43.352	0.2026	0.063	0.3113	0.47
Tangent	1478+43.352	1483+12.985	0.0889	0.057	0.6452	0.98
Simple Curve 8	1483+12.985	1505+09.701	0.4160	0.104	0.2508	0.38
Tangent	1505+09.701	1507+88.933	0.0529	0.011	0.1979	0.30
Simple Curve 9	1507+88.933	1518+44.144	0.1999	0.106	0.5297	0.81
Tangent	1518+44.144	1523+64.397	0.0985	0.067	0.6835	1.04
Simple Curve 10	1523+64.397	1548+64.398	0.4735	0.126	0.2654	0.40
Tangent	1548+64.398	1556+63.827	0.1514	0.034	0.2253	0.34
Simple Curve 11	1556+63.827	1570+18.580	0.2566	0.078	0.3045	0.46
Tangent	1570+18.580	1581+42.155	0.2128	0.054	0.2559	0.39
Simple Curve 12	1581+42.155	1600+40.495	0.3595	0.145	0.4036	0.61
Tangent	1600+40.495	1602+30.336	0.0360	0.007	0.1992	0.30
Simple Curve 13	1602+30.336	1621+46.738	0.3630	0.093	0.2557	0.39
Tangent	1621+46.738	1633+46.402	0.2272	0.108	0.4762	0.72
Simple Curve 14	1633+46.402	1652+11.160	0.3532	0.271	0.7663	1.17
Tangent	1652+11.160	1664+36.565	0.2321	0.076	0.3288	0.50
Simple Curve 15	1664+36.565	1675+12.295	0.2037	0.110	0.5394	0.82
Tangent	1675+12.295	1678+20.135	0.0583	0.045	0.7745	1.18



Title	Start Location	End Location	Length (mi)	Expected No. Crashes for Evaluation Period	Crash Rate (crashes/mi/yr)	Travel Crash Rate (crashes/million veh-mi)
Simple Curve 16	1678+20.135	1688+79.987	0.2007	0.090	0.4491	0.68
Tangent	1688+79.987	1693+40.960	0.0873	0.079	0.9023	1.37
Simple Curve 17	1693+40.960	1704+03.820	0.2013	0.196	0.9730	1.48
Tangent	1704+03.820	1718+73.301	0.2783	0.091	0.3273	0.50
Simple Curve 18	1718+73.301	1729+24.812	0.1991	0.053	0.2651	0.40
Tangent	1729+24.812	1738+90.122	0.1828	0.035	0.1888	0.29
Simple Curve 19	1738+90.122	1749+60.945	0.2028	0.097	0.4796	0.73
Tangent	1749+60.945	1753+37.825	0.0714	0.011	0.1566	0.24
Simple Curve 20	1753+37.825	1763+99.822	0.2011	0.044	0.2214	0.34
Tangent	1763+99.822	1783+38.648	0.3672	0.090	0.2439	0.37
Simple Curve 21	1783+38.648	1793+95.145	0.2001	0.067	0.3352	0.51
Tangent	1793+95.145	1806+82.524	0.2438	0.098	0.4025	0.61
Simple Curve 22	1806+82.524	1819+02.306	0.2310	0.163	0.7070	1.08
Tangent	1819+02.306	1837+12.472	0.3428	0.177	0.5172	0.79
Simple Curve 23	1837+12.472	1852+14.359	0.2844	0.107	0.3779	0.57
Tangent	1852+14.359	1855+90.269	0.0712	0.019	0.2617	0.40
Simple Curve 24	1855+90.269	1866+66.290	0.2038	0.079	0.3897	0.59
Tangent	1866+66.290	1887+17.885	0.3886	0.175	0.4496	0.68
Simple Curve 25	1887+17.885	1897+69.447	0.1992	0.107	0.5364	0.82
Tangent	1897+69.447	1900+15.731	0.0466	0.015	0.3126	0.48
Simple Curve 26	1900+15.731	1911+44.501	0.2138	0.148	0.6919	1.05
Tangent	1911+44.501	2059+91.129	2.8119	0.805	0.2862	0.44
Simple Curve 27	2059+91.129	2075+32.995	0.2920	0.092	0.3166	0.48
Tangent	2075+32.995	2129+49.536	1.0259	0.395	0.3853	0.59
Simple Curve 28	2129+49.536	2172+19.006	0.8086	0.160	0.1978	0.30
Tangent	2172+19.006	2189+34.430	0.3249	0.110	0.3390	0.52
Simple Curve 29	2189+34.430	2200+10.193	0.2037	0.147	0.7237	1.10
Tangent	2200+10.193	2241+30.583	0.7804	0.247	0.3166	0.48
Simple Curve 30	2241+30.583	2256+59.979	0.2897	0.099	0.3429	0.52
Tangent	2256+59.979	2264+09.452	0.1419	0.037	0.2635	0.40
Simple Curve 31	2264+09.452	2286+77.767	0.4296	0.143	0.3319	0.51
Tangent	2286+77.767	2313+38.578	0.5039	0.212	0.4204	0.64
Simple Curve 32	2313+38.578	2324+89.129	0.2179	0.147	0.6770	1.03
Tangent	2324+89.129	2376+93.270	0.9856	0.448	0.4546	0.69
Simple Curve 33	2376+93.270	2382+89.464	0.1129	0.086	0.7584	1.15
Tangent	2382+89.464	2388+00.142	0.0967	0.048	0.4933	0.75
Simple Curve 34	2388+00.142	2399+47.886	0.2174	0.162	0.7454	1.14
Tangent	2399+47.886	2404+59.393	0.0969	0.022	0.2318	0.35
Simple Curve 35	2404+59.393	2415+33.737	0.2035	0.076	0.3758	0.57
Tangent	2415+33.737	2424+38.143	0.1713	0.149	0.8679	1.32

**Table 7. Expected Segment Crash Type Distribution (Section 1)**

Element Type	Crash Type	FI Crashes	Percent FI (%)	PDO Crashes	Percent PDO (%)	Total Crashes	Percent Total (%)
Highway Segment	Collision with Animal	0.10	1.3	0.95	12.1	0.95	12.1
Highway Segment	Collision with Bicycle	0.01	0.1	0.01	0.1	0.02	0.2
Highway Segment	Other Single-vehicle Collision	0.02	0.2	0.15	1.9	0.17	2.1
Highway Segment	Overtaken	0.10	1.3	0.08	1.0	0.20	2.5
Highway Segment	Collision with Pedestrian	0.02	0.2	0.01	0.1	0.02	0.3
Highway Segment	Run Off Road	1.47	18.7	2.60	33.2	4.09	52.1
Highway Segment	Total Single Vehicle Crashes	1.72	21.9	3.79	48.3	5.44	69.3
Highway Segment	Angle Collision	0.27	3.5	0.37	4.7	0.67	8.5
Highway Segment	Head-on Collision	0.09	1.2	0.01	0.2	0.13	1.6
Highway Segment	Other Multiple-vehicle Collision	0.07	0.9	0.15	2.0	0.21	2.7
Highway Segment	Rear-end Collision	0.44	5.7	0.63	8.0	1.11	14.2
Highway Segment	Sideswipe	0.10	1.3	0.20	2.5	0.29	3.7
Highway Segment	Total Multiple Vehicle Crashes	0.98	12.5	1.37	17.4	2.41	30.7
Highway Segment	Total Highway Segment Crashes	2.70	34.4	5.16	65.7	7.85	100.0
	Total Crashes	2.70	34.4	5.16	65.7	7.85	100.0

**Note:** *Fatal and Injury Crashes* and *Property Damage Only Crashes* do not necessarily sum up to *Total Crashes* because the distribution of these three crashes had been derived independently.

*Interactive Highway Safety Design Model*

**Crash Prediction Evaluation Report**

**P2\_6 Alignment Alternative**

January 18, 2018



## **Disclaimer**

The Interactive Highway Design Model (IHSDM) software is disseminated under the sponsorship of the Department of Transportation in the interest of information exchange. The United States Government assumes no liability for its content or use thereof. This document does not constitute a standard, specification, or regulation.

The United States Government does not endorse products or manufacturers. Trade and manufacturers' names may appear in this software and documentation only because they are considered essential to the objective of the software.

## **Limited Warranty and Limitations of Remedies**

This software product is provided "as-is," without warranty of any kind-either expressed or implied (but not limited to the implied warranties of merchantability and fitness for a particular purpose). The FHWA do not warrant that the functions contained in the software will meet the end-user's requirements or that the operation of the software will be uninterrupted and error-free.

Under no circumstances will the FHWA be liable to the end-user for any damages or claimed lost profits, lost savings, or other incidental or consequential damages rising out of the use or inability to use the software (even if these organizations have been advised of the possibility of such damages), or for any claim by any other party.

## **Notice**

The use of the IHSDM software is being done strictly on a voluntary basis. In exchange for provision of IHSDM, the user agrees that the Federal Highway Administration (FHWA), U.S. Department of Transportation and any other agency of the Federal Government shall not be responsible for any errors, damage or other liability that may result from any and all use of the software, including installation and testing of the software. The user further agrees to hold the FHWA and the Federal Government harmless from any resulting liability. The user agrees that this hold harmless provision shall flow to any person to whom or any entity to which the user provides the IHSDM software. It is the user's full responsibility to inform any person to whom or any entity to which it provides the IHSDM software of this hold harmless provision.

---

---

## Table of Contents

<b>Report Overview</b> .....	<b>1</b>
<b>Section 1 Evaluation</b> .....	<b>2</b>

## List of Tables

Table Observed Crashes Used in the Evaluation (Section 1) .....	3
Table Evaluation Highway - Homogeneous Segments (Section 1) .....	4
Table Crash History Highway - Homogeneous Segments (Section 1) .....	7
Table Expected Highway Crash Rates and Frequencies (Section 1) .....	13
Table Expected Crash Frequencies and Rates by Highway Segment (Section 1) .....	13
Table Expected Crash Frequencies and Rates by Horizontal Design Element (Section 1) .....	16
Table Expected Segment Crash Type Distribution (Section 1) .....	18

## List of Figures

Figure Crash Prediction Summary (Section 1) .....	2
---	---

---

---

## Report Overview

**Report Generated:** Jan 18, 2018 8:50 AM

**Report Template:** System: Multi-Page, 508 Compliant [System] (mlcpm4, Oct 9, 2017 1:45 PM)

**Evaluation Date:** Tue Jan 16 15:52:55 AKST 2018

**IHSDM Version:** v13.0.0 (Sep 13, 2017)

**Crash Prediction Module:** v8.0.0 (Sep 13, 2017)

**User Name:** RaeAnne Hebnes

**Organization Name:** Michael Baker International

**Phone:**

**E-Mail:**

**Project Title:** Parks 305 - 325 v2

**Project Comment:** Created using wizard

**Project Unit System:** U.S. Customary

**Highway Title:** Alignment P2\_6\_1dec2017

**Highway Comment:** Alignment P2\_1dec2017 with 6% max grade

**Highway Version:** 1

**Evaluation Title:** Evaluation 17

**Evaluation Comment:** Created Tue Jan 16 15:50:34 AKST 2018

**Minimum Station:** 0.000

**Maximum Station:** 2424+38.143(1)

**Policy for Superelevation:** AASHTO 2011 U.S. Customary

**Calibration:** HSM Configuration

**Crash Distribution:** HSM Configuration

**Model/CMF:** HSM Configuration

**Empirical-Bayes Analysis:** Site-Specific

**Highway with Crash History:** Alignment ParksHwy304-326 Asbuilt - 60 mph

**Highway with Crash History Comment:** Created By Civil Geometry

**Highway with Crash History Version:** 1

**First Year of Analysis:** 2017

**Last Year of Analysis:** 2017

# Section 1 Evaluation

**Section:** Section 1  
**Evaluation Start Location:** 0.000  
**Evaluation End Location:** 2424+38.143(1)  
**Area Type:** Rural  
**Functional Class:** Arterial  
**Type of Alignment:** Undivided, Two Lane  
**Model Category:** Rural, Two Lane  
**Calibration Factor:** 2U=1.0;

Crash Prediction Summary, Section 1 (Undivided, Two Lane; Rural; Arterial)  
 Project: Parks 305 - 325 v2, Evaluation: Evaluation 17  
 Highway: Alignment P2\_6\_1dec2017

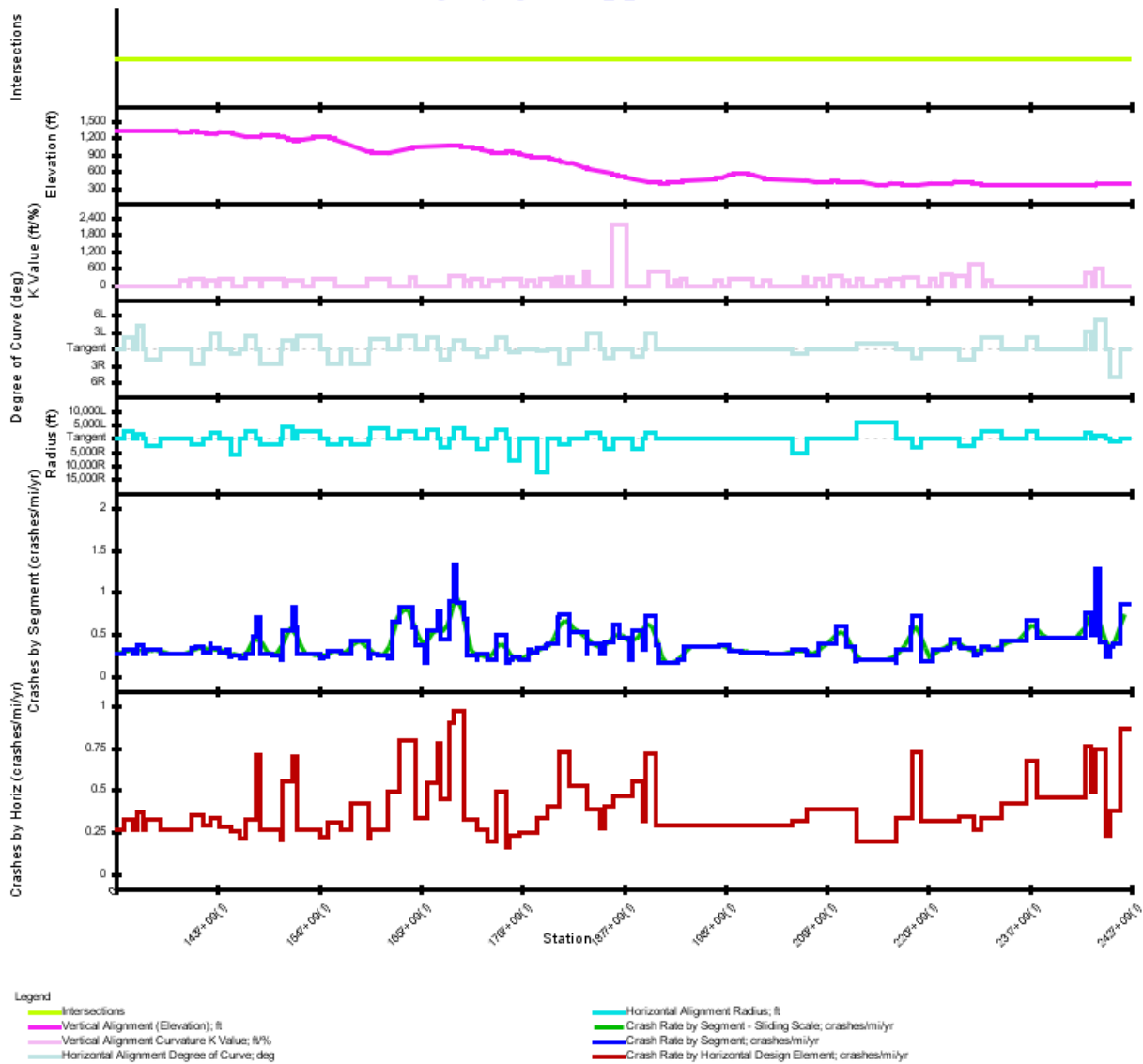

**Figure 1. Crash Prediction Summary (Section 1)**



**Table 1. Observed Crashes Used in the Evaluation (Section 1)**

Year	Observed Crashes	Total Crashes Used	FI Crashes	FI no/C Crashes	PDO Crashes
2010	9	7	3	1	4
2011	6	6	2	0	4
2012	7	7	2	0	5
2013	6	6	3	0	3
2014	17	16	7	0	9
All Years	45 &nbsp; <sup>[1]</sup>	42	17	1	25

**Footnotes**

<sup>[1]</sup> Note: Observed crash data that does not comply with the associated CPM model requirements may not be used in EB processing.

**Table 2. Evaluation Highway - Homogeneous Segments (Section 1)**

Seg. No.	Type	Start Location	End Location	Length (ft)	Length(mi)	AADT	Left Lane Width (ft)	Right Lane Width (ft)	Left Shoulder Width (ft)	Right Shoulder Width (ft)	Grade (%)	Driveway Density (driveways/mi)	Hazard Rating	Centerline Rumble Strip	Passing Lanes	TWLT Lane	Lighting	Automated Speed Enforcement	Radius (ft)	Superelevation (%)	Adverse	Design Speed (mph)
1	2U	0.000	1336+44.302(1)	935.30	0.1771	2017: 1,800	12.00	12.00	8.00	8.00	0.00	0.3	1	false	0	false	false	false				
2	2U	1336+44.302(1)	1345+88.891(1)	944.59	0.1789	2017: 1,800	12.00	12.00	8.00	8.00	0.00	0.3	1	false	0	false	false	false	2,864.79	2.0	true	70
3	2U	1345+88.891(1)	1350+43.605(1)	454.71	0.0861	2017: 1,800	12.00	12.00	8.00	8.00	0.00	0.3	1	false	0	false	false	false				
4	2U	1350+43.605(1)	1355+75.006(1)	531.40	0.1006	2017: 1,800	12.00	12.00	8.00	8.00	0.00	0.3	1	false	0	false	false	false	1,432.40	2.0	true	70
5	2U	1355+75.006(1)	1359+98.149(1)	423.14	0.0801	2017: 1,800	12.00	12.00	8.00	8.00	0.00	0.3	1	false	0	false	false	false				
6	2U	1359+98.149(1)	1375+23.561(1)	1,525.41	0.2889	2017: 1,800	12.00	12.00	8.00	8.00	0.00	0.3	1	false	0	false	false	false	2,864.79	2.0	true	70
7	2U	1375+23.561(1)	1393+00.000(1)	1,776.44	0.3365	2017: 1,800	12.00	12.00	8.00	8.00	0.00	0.3	1	false	0	false	false	false				
8	2U	1393+00.000(1)	1400+30.565(1)	730.57	0.1384	2017: 1,800	12.00	12.00	8.00	8.00	3.00	0.3	1	false	0	false	false	false				
9	2U	1400+30.565(1)	1409+13.059(1)	882.49	0.1671	2017: 1,800	12.00	12.00	8.00	8.00	2.10	0.3	1	false	0	false	false	false				
10	2U	1409+13.059(1)	1414+04.404(1)	491.35	0.0931	2017: 1,800	12.00	12.00	8.00	8.00	2.10	0.3	1	false	0	false	false	false	2,050.00	2.0	true	70
11	2U	1414+04.404(1)	1421+34.750(1)	730.35	0.1383	2017: 1,800	12.00	12.00	8.00	8.00	3.50	0.3	1	false	0	false	false	false	2,050.00	2.0	true	70
12	2U	1421+34.750(1)	1429+14.713(1)	779.96	0.1477	2017: 1,800	12.00	12.00	8.00	8.00	3.50	0.3	1	false	0	false	false	false				
13	2U	1429+14.713(1)	1429+71.777(1)	57.06	0.0108	2017: 1,800	12.00	12.00	8.00	8.00	3.50	0.3	1	false	0	false	false	false	2,050.00	2.0	true	70
14	2U	1429+71.777(1)	1439+70.699(1)	998.92	0.1892	2017: 1,800	12.00	12.00	8.00	8.00	2.32	0.3	1	false	0	false	false	false	2,050.00	2.0	true	70
15	2U	1439+70.699(1)	1446+51.376(1)	680.68	0.1289	2017: 1,800	12.00	12.00	8.00	8.00	2.32	0.3	1	false	0	false	false	false				
16	2U	1446+51.376(1)	1449+40.000(1)	288.62	0.0547	2017: 1,800	12.00	12.00	8.00	8.00	3.50	0.3	1	false	0	false	false	false				
17	2U	1449+40.000(1)	1451+33.375(1)	193.38	0.0366	2017: 1,800	12.00	12.00	8.00	8.00	3.50	0.3	1	false	1	false	false	false				
18	2U	1451+33.375(1)	1461+98.062(1)	1,064.69	0.2016	2017: 1,800	12.00	12.00	8.00	8.00	3.50	0.3	1	false	1	false	false	false	6,100.00	2.0	true	70
19	2U	1461+98.062(1)	1467+73.811(1)	575.75	0.1090	2017: 1,800	12.00	12.00	8.00	8.00	3.50	0.3	1	false	1	false	false	false				
20	2U	1467+73.811(1)	1475+38.715(1)	764.90	0.1449	2017: 1,800	12.00	12.00	8.00	8.00	3.50	0.3	1	false	1	false	false	false	2,600.00	2.0	true	70
21	2U	1475+38.715(1)	1478+43.352(1)	304.64	0.0577	2017: 1,800	12.00	12.00	8.00	8.00	3.38	0.3	1	false	1	false	false	false	2,600.00	2.0	true	70
22	2U	1478+43.352(1)	1483+12.985(1)	469.63	0.0890	2017: 1,800	12.00	12.00	8.00	8.00	3.38	0.3	1	false	1	false	false	false				
23	2U	1483+12.985(1)	1496+61.507(1)	1,348.52	0.2554	2017: 1,800	12.00	12.00	8.00	8.00	3.38	0.3	1	false	1	false	false	false	2,050.00	2.0	true	70
24	2U	1496+61.507(1)	1505+09.701(1)	848.19	0.1606	2017: 1,800	12.00	12.00	8.00	8.00	6.00	0.3	1	false	1	false	false	false	2,050.00	2.0	true	70
25	2U	1505+09.701(1)	1507+88.933(1)	279.23	0.0529	2017: 1,800	12.00	12.00	8.00	8.00	6.00	0.3	1	false	1	false	false	false				
26	2U	1507+88.933(1)	1518+44.144(1)	1,055.21	0.1998	2017: 1,800	12.00	12.00	8.00	8.00	6.00	0.3	1	false	1	false	false	false	4,100.00	2.0	true	70
27	2U	1518+44.144(1)	1520+94.599(1)	250.45	0.0474	2017: 1,800	12.00	12.00	8.00	8.00	6.00	0.3	1	false	1	false	false	false				
28	2U	1520+94.599(1)	1523+64.397(1)	269.80	0.0511	2017: 1,800	12.00	12.00	8.00	8.00	3.78	0.3	1	false	1	false	false	false				
29	2U	1523+64.397(1)	1548+64.398(1)	2,500.00	0.4735	2017: 1,800	12.00	12.00	8.00	8.00	3.78	0.3	1	false	1	false	false	false	2,500.00	2.0	true	70
30	2U	1548+64.398(1)	1552+17.143(1)	352.75	0.0668	2017: 1,800	12.00	12.00	8.00	8.00	3.78	0.3	1	false	1	false	false	false				
31	2U	1552+17.143(1)	1556+63.827(1)	446.68	0.0846	2017: 1,800	12.00	12.00	8.00	8.00	6.00	0.3	1	false	1	false	false	false				
32	2U	1556+63.827(1)	1570+18.580(1)	1,354.75	0.2566	2017: 1,800	12.00	12.00	8.00	8.00	6.00	0.3	1	false	1	false	false	false	2,047.00	2.0	true	70
33	2U	1570+18.580(1)	1581+42.155(1)	1,123.58	0.2128	2017: 1,800	12.00	12.00	8.00	8.00	6.00	0.3	1	false	1	false	false	false				
34	2U	1581+42.155(1)	1600+40.495(1)	1,898.34	0.3595	2017: 1,800	12.00	12.00	8.00	8.00	6.00	0.3	1	false	1	false	false	false	2,153.00	2.0	true	70
35	2U	1600+40.495(1)	1602+30.336(1)	189.84	0.0360	2017: 1,800	12.00	12.00	8.00	8.00	6.00	0.3	1	false	1	false	false	false				
36	2U	1602+30.336(1)	1610+70.100(1)	839.76	0.1590	2017: 1,800	12.00	12.00	8.00	8.00	6.00	0.3	1	false	1	false	false	false	3,600.00	2.0	true	70
37	2U	1610+70.100(1)	1621+46.738(1)	1,076.64	0.2039	2017: 1,800	12.00	12.00	8.00	8.00	3.35	0.3	1	false	1	false	false	false	3,600.00	2.0	true	70
38	2U	1621+46.738(1)	1625+90.000(1)	443.26	0.0839	2017: 1,800	12.00	12.00	8.00	8.00	3.35	0.3	1	false	1	false	false	false				
39	2U	1625+90.000(1)	1633+46.402(1)	756.40	0.1433	2017: 1,800	12.00	12.00	8.00	8.00	3.35	0.3	1	false	0	false	false	false				
40	2U	1633+46.402(1)	1649+14.793(1)	1,568.39	0.2970	2017: 1,800	12.00	12.00	8.00	8.00	3.35	0.3	1	false	0	false	false	false	2,550.00	2.0	true	70

Seg. No.	Type	Start Location	End Location	Length (ft)	Length (mi)	AADT	Left Lane Width (ft)	Right Lane Width (ft)	Left Shoulder Width (ft)	Right Shoulder Width (ft)	Grade (%)	Driveway Density (driveways/mi)	Hazard Rating	Centerline Rumble Strip	Passing Lanes	TWLT Lane	Lighting	Automated Speed Enforcement	Radius (ft)	Superelevation (%)	Adverse	Design Speed (mph)
41	2U	1649+14.793(1)	1652+11.160(1)	296.37	0.0561	2017: 1,800	12.00	12.00	8.00	8.00	1.01	0.3	1	false	0	false	false	false	2,550.00	2.0	true	70
42	2U	1652+11.160(1)	1661+79.000(1)	967.84	0.1833	2017: 1,800	12.00	12.00	8.00	8.00	1.01	0.3	1	false	0	false	false	false				
43	2U	1661+79.000(1)	1664+36.565(1)	257.56	0.0488	2017: 1,800	12.00	12.00	8.00	8.00	1.01	0.3	1	false	2	false	false	false				
44	2U	1664+36.565(1)	1675+12.295(1)	1,075.73	0.2037	2017: 1,800	12.00	12.00	8.00	8.00	1.01	0.3	1	false	2	false	false	false	3,000.00	2.0	true	70
45	2U	1675+12.295(1)	1678+20.135(1)	307.84	0.0583	2017: 1,800	12.00	12.00	8.00	8.00	1.01	0.3	1	false	2	false	false	false				
46	2U	1678+20.135(1)	1688+79.987(1)	1,059.85	0.2007	2017: 1,800	12.00	12.00	8.00	8.00	1.01	0.3	1	false	2	false	false	false	3,100.00	2.0	true	70
47	2U	1688+79.987(1)	1693+40.960(1)	460.97	0.0873	2017: 1,800	12.00	12.00	8.00	8.00	1.01	0.3	1	false	2	false	false	false				
48	2U	1693+40.960(1)	1695+70.734(1)	229.77	0.0435	2017: 1,800	12.00	12.00	8.00	8.00	1.01	0.3	1	false	2	false	false	false	3,900.00	2.0	true	70
49	2U	1695+70.734(1)	1704+03.820(1)	833.09	0.1578	2017: 1,800	12.00	12.00	8.00	8.00	4.00	0.3	1	false	2	false	false	false	3,900.00	2.0	true	70
50	2U	1704+03.820(1)	1706+93.795(1)	289.98	0.0549	2017: 1,800	12.00	12.00	8.00	8.00	4.00	0.3	1	false	2	false	false	false				
51	2U	1706+93.795(1)	1718+16.939(1)	1,123.14	0.2127	2017: 1,800	12.00	12.00	8.00	8.00	0.71	0.3	1	false	2	false	false	false				
52	2U	1718+16.939(1)	1718+73.301(1)	56.36	0.0107	2017: 1,800	12.00	12.00	8.00	8.00	5.00	0.3	1	false	2	false	false	false				
53	2U	1718+73.301(1)	1729+24.812(1)	1,051.51	0.1991	2017: 1,800	12.00	12.00	8.00	8.00	5.00	0.3	1	false	2	false	false	false	4,000.00	2.0	true	70
54	2U	1729+24.812(1)	1738+90.122(1)	965.31	0.1828	2017: 1,800	12.00	12.00	8.00	8.00	5.00	0.3	1	false	2	false	false	false				
55	2U	1738+90.122(1)	1739+01.335(1)	11.21	0.0021	2017: 1,800	12.00	12.00	8.00	8.00	5.00	0.3	1	false	2	false	false	false	3,100.00	2.0	true	70
56	2U	1739+01.335(1)	1749+60.945(1)	1,059.61	0.2007	2017: 1,800	12.00	12.00	8.00	8.00	2.72	0.3	1	false	2	false	false	false	3,100.00	2.0	true	70
57	2U	1749+60.945(1)	1753+37.825(1)	376.88	0.0714	2017: 1,800	12.00	12.00	8.00	8.00	2.72	0.3	1	false	2	false	false	false				
58	2U	1753+37.825(1)	1756+19.308(1)	281.48	0.0533	2017: 1,800	12.00	12.00	8.00	8.00	2.72	0.3	1	false	2	false	false	false	8,000.00	2.0	true	70
59	2U	1756+19.308(1)	1763+99.822(1)	780.51	0.1478	2017: 1,800	12.00	12.00	8.00	8.00	5.00	0.3	1	false	2	false	false	false	8,000.00	2.0	true	70
60	2U	1763+99.822(1)	1773+79.000(1)	979.18	0.1855	2017: 1,800	12.00	12.00	8.00	8.00	5.00	0.3	1	false	2	false	false	false				
61	2U	1773+79.000(1)	1776+44.892(1)	265.89	0.0504	2017: 1,800	12.00	12.00	8.00	8.00	5.00	0.3	1	false	0	false	false	false				
62	2U	1776+44.892(1)	1783+38.648(1)	693.76	0.1314	2017: 1,800	12.00	12.00	8.00	8.00	0.27	0.3	1	false	0	false	false	false				
63	2U	1783+38.648(1)	1793+15.024(1)	976.38	0.1849	2017: 1,800	12.00	12.00	8.00	8.00	0.27	0.3	1	false	0	false	false	false	12,700.00	2.0	true	70
64	2U	1793+15.024(1)	1793+95.145(1)	80.12	0.0152	2017: 1,800	12.00	12.00	8.00	8.00	4.85	0.3	1	false	0	false	false	false	12,700.00	2.0	true	70
65	2U	1793+95.145(1)	1806+14.814(1)	1,219.67	0.2310	2017: 1,800	12.00	12.00	8.00	8.00	4.85	0.3	1	false	0	false	false	false				
66	2U	1806+14.814(1)	1806+82.524(1)	67.71	0.0128	2017: 1,800	12.00	12.00	8.00	8.00	3.24	0.3	1	false	0	false	false	false				
67	2U	1806+82.524(1)	1818+59.631(1)	1,177.11	0.2229	2017: 1,800	12.00	12.00	8.00	8.00	3.24	0.3	1	false	0	false	false	false	2,150.00	2.0	true	70
68	2U	1818+59.631(1)	1819+02.306(1)	42.67	0.0081	2017: 1,800	12.00	12.00	8.00	8.00	5.00	0.3	1	false	0	false	false	false	2,150.00	2.0	true	70
69	2U	1819+02.306(1)	1837+08.045(1)	1,805.74	0.3420	2017: 1,800	12.00	12.00	8.00	8.00	5.00	0.3	1	false	0	false	false	false				
70	2U	1837+08.045(1)	1837+12.472(1)	4.43	0.0008	2017: 1,800	12.00	12.00	8.00	8.00	3.95	0.3	1	false	0	false	false	false				
71	2U	1837+12.472(1)	1852+14.359(1)	1,501.89	0.2844	2017: 1,800	12.00	12.00	8.00	8.00	3.95	0.3	1	false	0	false	false	false	2,050.00	2.0	true	70
72	2U	1852+14.359(1)	1855+90.269(1)	375.91	0.0712	2017: 1,800	12.00	12.00	8.00	8.00	3.95	0.3	1	false	0	false	false	false				
73	2U	1855+90.269(1)	1866+66.290(1)	1,076.02	0.2038	2017: 1,800	12.00	12.00	8.00	8.00	3.95	0.3	1	false	0	false	false	false	3,600.00	2.0	true	70
74	2U	1866+66.290(1)	1872+40.458(1)	574.17	0.1087	2017: 1,800	12.00	12.00	8.00	8.00	3.95	0.3	1	false	0	false	false	false				
75	2U	1872+40.458(1)	1884+00.000(1)	1,159.54	0.2196	2017: 1,800	12.00	12.00	8.00	8.00	3.16	0.3	1	false	0	false	false	false				
76	2U	1884+00.000(1)	1887+17.885(1)	317.88	0.0602	2017: 1,800	12.00	12.00	8.00	8.00	3.16	0.3	1	false	2	false	false	false				
77	2U	1887+17.885(1)	1897+69.447(1)	1,051.56	0.1992	2017: 1,800	12.00	12.00	8.00	8.00	3.16	0.3	1	false	2	false	false	false	3,700.00	2.0	true	70
78	2U	1897+69.447(1)	1900+15.731(1)	246.28	0.0466	2017: 1,800	12.00	12.00	8.00	8.00	3.16	0.3	1	false	2	false	false	false				
79	2U	1900+15.731(1)	1911+44.501(1)	1,128.77	0.2138	2017: 1,800	12.00	12.00	8.00	8.00	3.16	0.3	1	false	2	false	false	false	2,050.00	2.0	true	70
80	2U	1911+44.501(1)	1914+69.648(1)	325.15	0.0616	2017: 1,800	12.00	12.00	8.00	8.00	3.16	0.3	1	false	2	false	false	false				
81	2U	1914+69.648(1)	1935+13.440(1)	2,043.79	0.3871	2017: 1,800	12.00	12.00	8.00	8.00	0.89	0.3	1	false	2	false	false	false				
82	2U	1935+13.440(1)	1942+14.172(1)	700.73	0.1327	2017: 1,800	12.00	12.00	8.00	8.00	3.42	0.3	1	false	2	false	false	false				
83	2U	1942+14.172(1)	1979+48.414(1)	3,734.24	0.7072	2017: 1,800	12.00	12.00	8.00	8.00	1.25	0.3	1	false	2	false	false	false				

Seg. No.	Type	Start Location	End Location	Length (ft)	Length (mi)	AADT	Left Lane Width (ft)	Right Lane Width (ft)	Left Shoulder Width (ft)	Right Shoulder Width (ft)	Grade (%)	Driveway Density (driveways/mi)	Hazard Rating	Centerline Rumble Strip	Passing Lanes	TWLT Lane	Lighting	Automated Speed Enforcement	Radius (ft)	Superelevation (%)	Adverse	Design Speed (mph)
84	2U	1979+48.414(1)	1990+96.000(1)	1,147.59	0.2173	2017: 1,800	12.00	12.00	8.00	8.00	5.00	0.3	1	false	2	false	false	false				
85	2U	1990+96.000(1)	2004+08.375(1)	1,312.38	0.2486	2017: 1,800	12.00	12.00	8.00	8.00	5.00	0.3	1	false	0	false	false	false				
86	2U	2004+08.375(1)	2032+26.622(1)	2,818.25	0.5338	2017: 1,800	12.00	12.00	8.00	8.00	5.00	0.3	1	false	0	false	false	false				
87	2U	2032+26.622(1)	2059+91.129(1)	2,764.51	0.5236	2017: 1,800	12.00	12.00	8.00	8.00	0.62	0.3	1	false	0	false	false	false				
88	2U	2059+91.129(1)	2073+83.086(1)	1,391.96	0.2636	2017: 1,800	12.00	12.00	8.00	8.00	0.62	0.3	1	false	0	false	false	false	5,729.58	2.0	true	70
89	2U	2073+83.086(1)	2075+32.995(1)	149.91	0.0284	2017: 1,800	12.00	12.00	8.00	8.00	1.90	0.3	1	false	0	false	false	false	5,729.58	2.0	true	70
90	2U	2075+32.995(1)	2088+98.505(1)	1,365.51	0.2586	2017: 1,800	12.00	12.00	8.00	8.00	1.90	0.3	1	false	0	false	false	false				
91	2U	2088+98.505(1)	2107+64.701(1)	1,866.20	0.3534	2017: 1,800	12.00	12.00	8.00	8.00	1.37	0.3	1	false	0	false	false	false				
92	2U	2107+64.701(1)	2118+80.968(1)	1,116.27	0.2114	2017: 1,800	12.00	12.00	8.00	8.00	2.49	0.3	1	false	0	false	false	false				
93	2U	2118+80.968(1)	2127+46.000(1)	865.03	0.1638	2017: 1,800	12.00	12.00	8.00	8.00	0.49	0.3	1	false	0	false	false	false				
94	2U	2127+46.000(1)	2129+49.536(1)	203.54	0.0386	2017: 1,800	12.00	12.00	8.00	8.00	0.49	0.3	1	false	2	false	false	false				
95	2U	2129+49.536(1)	2132+09.424(1)	259.89	0.0492	2017: 1,800	12.00	12.00	8.00	8.00	0.49	0.3	1	false	2	false	false	false	5,729.58	2.0	true	70
96	2U	2132+09.424(1)	2156+63.518(1)	2,454.09	0.4648	2017: 1,800	12.00	12.00	8.00	8.00	2.11	0.3	1	false	2	false	false	false	5,729.58	2.0	true	70
97	2U	2156+63.518(1)	2172+19.006(1)	1,555.49	0.2946	2017: 1,800	12.00	12.00	8.00	8.00	2.21	0.3	1	false	2	false	false	false	5,729.58	2.0	true	70
98	2U	2172+19.006(1)	2172+26.614(1)	7.61	0.0014	2017: 1,800	12.00	12.00	8.00	8.00	2.21	0.3	1	false	2	false	false	false				
99	2U	2172+26.614(1)	2188+12.331(1)	1,585.72	0.3003	2017: 1,800	12.00	12.00	8.00	8.00	3.26	0.3	1	false	2	false	false	false				
100	2U	2188+12.331(1)	2189+34.430(1)	122.10	0.0231	2017: 1,800	12.00	12.00	8.00	8.00	2.00	0.3	1	false	2	false	false	false				
101	2U	2189+34.430(1)	2200+10.193(1)	1,075.76	0.2037	2017: 1,800	12.00	12.00	8.00	8.00	2.00	0.3	1	false	2	false	false	false	3,300.00	2.0	true	70
102	2U	2200+10.193(1)	2212+68.167(1)	1,257.97	0.2382	2017: 1,800	12.00	12.00	8.00	8.00	2.00	0.3	1	false	2	false	false	false				
103	2U	2212+68.167(1)	2227+11.813(1)	1,443.65	0.2734	2017: 1,800	12.00	12.00	8.00	8.00	0.41	0.3	1	false	2	false	false	false				
104	2U	2227+11.813(1)	2230+62.000(1)	350.19	0.0663	2017: 1,800	12.00	12.00	8.00	8.00	2.34	0.3	1	false	2	false	false	false				
105	2U	2230+62.000(1)	2241+30.583(1)	1,068.58	0.2024	2017: 1,800	12.00	12.00	8.00	8.00	2.34	0.3	1	false	0	false	false	false				
106	2U	2241+30.583(1)	2242+42.790(1)	112.21	0.0213	2017: 1,800	12.00	12.00	8.00	8.00	2.34	0.3	1	false	0	false	false	false	2,788.70	2.0	true	70
107	2U	2242+42.790(1)	2256+59.979(1)	1,417.19	0.2684	2017: 1,800	12.00	12.00	8.00	8.00	1.64	0.3	1	false	0	false	false	false	2,788.70	2.0	true	70
108	2U	2256+59.979(1)	2259+05.408(1)	245.43	0.0465	2017: 1,800	12.00	12.00	8.00	8.00	1.64	0.3	1	false	0	false	false	false				
109	2U	2259+05.408(1)	2264+09.452(1)	504.04	0.0955	2017: 1,800	12.00	12.00	8.00	8.00	3.40	0.3	1	false	0	false	false	false				
110	2U	2264+09.452(1)	2272+06.202(1)	796.75	0.1509	2017: 1,800	12.00	12.00	8.00	8.00	3.40	0.3	1	false	0	false	false	false	2,788.70	2.0	true	70
111	2U	2272+06.202(1)	2286+77.767(1)	1,471.57	0.2787	2017: 1,800	12.00	12.00	8.00	8.00	0.10	0.3	1	false	0	false	false	false	2,788.70	2.0	true	70
112	2U	2286+77.767(1)	2313+38.578(1)	2,660.81	0.5039	2017: 1,800	12.00	12.00	8.00	8.00	0.10	0.3	1	false	0	false	false	false				
113	2U	2313+38.578(1)	2324+89.129(1)	1,150.55	0.2179	2017: 1,800	12.00	12.00	8.00	8.00	0.10	0.3	1	false	0	false	false	false	2,864.09	2.0	true	70
114	2U	2324+89.129(1)	2376+93.270(1)	5,204.14	0.9856	2017: 1,800	12.00	12.00	8.00	8.00	0.10	0.3	1	false	0	false	false	false				
115	2U	2376+93.270(1)	2381+06.049(1)	412.78	0.0782	2017: 1,800	12.00	12.00	8.00	8.00	0.10	0.3	1	false	0	false	false	false	1,909.86	2.0	true	70
116	2U	2381+06.049(1)	2382+89.464(1)	183.41	0.0347	2017: 1,800	12.00	12.00	8.00	8.00	1.65	0.3	1	false	0	false	false	false	1,909.86	2.0	true	70
117	2U	2382+89.464(1)	2388+00.142(1)	510.68	0.0967	2017: 1,800	12.00	12.00	8.00	8.00	1.65	0.3	1	false	0	false	false	false				
118	2U	2388+00.142(1)	2392+46.808(1)	446.67	0.0846	2017: 1,800	12.00	12.00	8.00	8.00	1.65	0.3	1	false	0	false	false	false	1,145.92	2.0	true	70
119	2U	2392+46.808(1)	2399+47.886(1)	701.08	0.1328	2017: 1,800	12.00	12.00	8.00	8.00	0.46	0.3	1	false	0	false	false	false	1,145.92	2.0	true	70
120	2U	2399+47.886(1)	2404+59.393(1)	511.51	0.0969	2017: 1,800	12.00	12.00	8.00	8.00	0.46	0.3	1	false	0	false	false	false				
121	2U	2404+59.393(1)	2407+00.000(1)	240.61	0.0456	2017: 1,800	12.00	12.00	8.00	8.00	0.46	0.3	1	false	0	false	false	false	1,145.91	2.0	true	70
122	2U	2407+00.000(1)	2415+33.737(1)	833.74	0.1579	2017: 1,800	12.00	12.00	8.00	8.00	0.00	0.3	1	false	0	false	false	false	1,145.91	2.0	true	70
123	2U	2415+33.737(1)	2424+38.143(1)	904.41	0.1713	2017: 1,800	12.00	12.00	8.00	8.00	0.00	0.3	1	false	0	false	false	false				

**Table 3. Crash History Highway - Homogeneous Segments (Section 1)**

Seg. No.	Type	Start Location	End Location	Length (ft)	Length (mi)	AADT	Left Lane Width (ft)	Right Lane Width (ft)	Left Shoulder Width (ft)	Right Shoulder Width (ft)	Grade (%)	Driveway Density (driveways/mi)	Hazard Rating	Centerline Rumble Strip	Passing Lanes	TW LT Lane	Lighting	Automated Speed Enforcement	Radius (ft)	Superelevation (%)	Adverse	Design Speed (mph)
1	2U	1327+09.00	1336+44.30	935.30	0.177	2010-2014: 1,800	12.0	12.0	8.00	8.00	0.00	0.3	1	false	0	false	false	false				
2	2U	1336+44.30	1341+64.74	520.17	0.098	2010-2014: 1,800	12.0	12.0	8.00	8.00	0.00	0.3	1	false	0	false	false	false	2,864.79	2.0	true	60
3	2U	1341+64.74	1345+88.91	424.42	0.080	2010-2014: 1,800	12.0	12.0	8.00	8.00	0.00	0.3	1	false	0	false	false	false	2,864.79	2.0	true	60
4	2U	1345+88.91	1349+42.43	353.55	0.067	2010-2014: 1,800	12.0	12.0	8.00	8.00	0.00	0.3	1	false	0	false	false	false				
5	2U	1349+42.43	1350+43.65	101.17	0.019	2010-2014: 1,800	12.0	12.0	8.00	8.00	0.00	0.3	1	false	0	false	false	false				
6	2U	1350+43.65	1355+75.06	531.40	0.100	2010-2014: 1,800	12.0	12.0	8.00	8.00	0.00	0.3	1	false	0	false	false	false	1,432.40	2.0	true	60
7	2U	1355+75.06	1359+98.14	423.14	0.080	2010-2014: 1,800	12.0	12.0	8.00	8.00	0.00	0.3	1	false	0	false	false	false				
8	2U	1359+98.14	1361+84.49	186.30	0.035	2010-2014: 1,800	12.0	12.0	8.00	8.00	0.00	0.3	1	false	0	false	false	false	2,864.79	2.0	true	60
9	2U	1361+84.49	1372+13.91	1,029.46	0.195	2010-2014: 1,800	12.0	12.0	8.00	8.00	0.00	0.3	1	false	0	false	false	false	2,864.79	2.0	true	60
10	2U	1372+13.91	1375+23.56	309.65	0.058	2010-2014: 1,800	12.0	12.0	8.00	8.00	0.00	0.3	1	false	0	false	false	false	2,864.79	2.0	true	60
11	2U	1375+23.56	1403+14.12	2,790.58	0.528	2010-2014: 1,800	12.0	12.0	8.00	8.00	0.00	0.3	1	false	0	false	false	false				
12	2U	1403+14.12	1409+56.09	641.96	0.121	2010-2014: 1,800	12.0	12.0	8.00	8.00	0.00	0.3	1	false	0	false	false	false				
13	2U	1409+56.09	1413+11.58	355.48	0.067	2010-2014: 1,800	12.0	12.0	8.00	8.00	0.00	0.3	1	false	0	false	false	false	1,909.86	2.0	true	60
14	2U	1413+11.58	1420+94.27	782.69	0.148	2010-2014: 1,800	12.0	12.0	8.00	8.00	0.00	0.3	1	false	0	false	false	false	1,909.86	2.0	true	60
15	2U	1420+94.27	1425+01.19	406.75	0.077	2010-2014: 1,800	12.0	12.0	8.00	8.00	0.00	0.3	1	false	0	false	false	false				
16	2U	1425+01.19	1429+54.31	453.31	0.085	2010-2014: 1,800	12.0	12.0	8.00	8.00	0.00	0.3	1	false	0	false	false	false				
17	2U	1429+54.31	1434+88.07	533.72	0.101	2010-2014: 1,800	12.0	12.0	8.00	8.00	0.00	0.3	1	false	0	false	false	false	1,909.86	2.0	true	60
18	2U	1434+88.07	1439+38.25	450.21	0.085	2010-2014: 1,800	12.0	12.0	8.00	8.00	0.00	0.3	1	false	0	false	false	false	1,909.86	2.0	true	60
19	2U	1439+38.25	1442+00.00	261.74	0.049	2010-2014: 1,800	12.0	12.0	8.00	8.00	0.00	0.3	1	false	0	false	false	false				
20	2U	1442+00.00	1445+85.72	385.73	0.073	2010-2014: 1,800	12.0	12.0	8.00	8.00	0.00	0.3	1	false	1	false	false	false				
21	2U	1445+85.72	1454+00.00	814.27	0.154	2010-2014: 1,800	12.0	12.0	8.00	8.00	0.00	0.3	1	false	1	false	false	false				
22	2U	1454+00.00	1457+87.86	387.87	0.073	2010-2014: 1,800	12.0	12.0	8.00	8.00	0.00	0.3	1	false	0	false	false	false				
23	2U	1457+87.86	1463+32.94	545.07	0.103	2010-2014: 1,800	12.0	12.0	8.00	8.00	0.00	0.3	1	false	0	false	false	false	2,864.79	2.0	true	60
24	2U	1463+32.94	1468+59.08	526.15	0.099	2010-2014: 1,800	12.0	12.0	8.00	8.00	0.00	0.3	1	false	0	false	false	false				
25	2U	1468+59.08	1473+71.09	512.00	0.097	2010-2014: 1,800	12.0	12.0	8.00	8.00	0.00	0.3	1	false	0	false	false	false	1,950.00	2.0	true	60
26	2U	1473+71.09	1477+61.95	390.86	0.074	2010-2014: 1,800	12.0	12.0	8.00	8.00	0.00	0.3	1	false	0	false	false	false	1,950.00	2.0	true	60
27	2U	1477+61.95	1482+39.57	477.61	0.090	2010-2014: 1,800	12.0	12.0	8.00	8.00	0.00	0.3	1	false	0	false	false	false				
28	2U	1482+39.57	1490+31.09	791.52	0.149	2010-2014: 1,800	12.0	12.0	8.00	8.00	0.00	0.3	1	false	0	false	false	false				
29	2U	1490+31.09	1502+99.26	1,268.17	0.240	2010-2014: 1,800	12.0	12.0	8.00	8.00	0.00	0.3	1	false	0	false	false	false	1,155.00	2.0	true	60
30	2U	1502+99.26	1506+85.12	385.86	0.073	2010-2014: 1,800	12.0	12.0	8.00	8.00	0.00	0.3	1	false	0	false	false	false	1,155.00	2.0	true	60
31	2U	1506+85.12	1511+36.05	450.93	0.085	2010-2014: 1,800	12.0	12.0	8.00	8.00	0.00	0.3	1	false	0	false	false	false				
32	2U	1511+36.05	1518+02.29	666.24	0.126	2010-2014: 1,800	12.0	12.0	8.00	8.00	0.00	0.3	1	false	0	false	false	false	1,145.92	2.0	true	60
33	2U	1518+02.29	1522+56.44	454.15	0.086	2010-2014: 1,800	12.0	12.0	8.00	8.00	0.00	0.3	1	false	0	false	false	false				
34	2U	1522+56.44	1530+56.75	800.32	0.151	2010-2014: 1,800	12.0	12.0	8.00	8.00	0.00	0.3	1	false	0	false	false	false				

Seg. No.	Type	Start Location	End Location	Length (ft)	Length (mi)	AADT	Left Lane Width (ft)	Right Lane Width (ft)	Left Shoulder Width (ft)	Right Shoulder Width (ft)	Grade (%)	Driveway Density (driveways/mi)	Hazard Rating	Centerline Rumble Strip	Passing Lanes	TW LT Lane	Lighting	Automated Speed Enforcement	Radius (ft)	Superelevation (%)	Adverse	Design Speed (mph)
35	2U	1530+56.765	1532+29.037	172.27	0.0326	2010-2014: 1,800	12.00	12.00	8.00	8.00	0.00	0.3	1	false	0	false	false	false	1,440.0	2.0	true	60
36	2U	1532+29.037	1546+35.066	1,406.03	0.2663	2010-2014: 1,800	12.00	12.00	8.00	8.00	0.00	0.3	1	false	0	false	false	false	1,440.0	2.0	true	60
37	2U	1546+35.066	1555+00.000	864.93	0.1638	2010-2014: 1,800	12.00	12.00	8.00	8.00	0.00	0.3	1	false	0	false	false	false				
38	2U	1555+00.000	1555+42.935	42.94	0.0081	2010-2014: 1,800	12.00	12.00	8.00	8.00	0.00	0.3	1	false	1	false	false	false				
39	2U	1555+42.935	1561+65.077	622.14	0.1178	2010-2014: 1,800	12.00	12.00	8.00	8.00	0.00	0.3	1	false	1	false	false	false				
40	2U	1561+65.077	1568+88.080	723.00	0.1369	2010-2014: 1,800	12.00	12.00	8.00	8.00	0.00	0.3	1	false	1	false	false	false	1,152.0	2.0	true	60
41	2U	1568+88.080	1575+49.666	661.59	0.1253	2010-2014: 1,800	12.00	12.00	8.00	8.00	0.00	0.3	1	false	1	false	false	false	1,152.0	2.0	true	60
42	2U	1575+49.666	1579+81.473	431.81	0.0818	2010-2014: 1,800	12.00	12.00	8.00	8.00	0.00	0.3	1	false	1	false	false	false				
43	2U	1579+81.473	1587+62.614	781.14	0.1479	2010-2014: 1,800	12.00	12.00	8.00	8.00	0.00	0.3	1	false	1	false	false	false	881.47	2.0	true	60
44	2U	1587+62.614	1589+20.405	157.79	0.0299	2010-2014: 1,800	12.00	12.00	8.00	8.00	0.00	0.3	1	false	1	false	false	false				
45	2U	1589+20.405	1591+85.378	264.97	0.0502	2010-2014: 1,800	12.00	12.00	8.00	8.00	0.00	0.3	1	false	1	false	false	false				
46	2U	1591+85.378	1598+89.259	703.88	0.1333	2010-2014: 1,800	12.00	12.00	8.00	8.00	0.00	0.3	1	false	1	false	false	false	825.00	2.0	true	60
47	2U	1598+89.259	1604+98.065	608.81	0.1153	2010-2014: 1,800	12.00	12.00	8.00	8.00	0.00	0.3	1	false	1	false	false	false	825.00	2.0	true	60
48	2U	1604+98.065	1609+35.192	437.13	0.0828	2010-2014: 1,800	12.00	12.00	8.00	8.00	0.00	0.3	1	false	1	false	false	false				
49	2U	1609+35.192	1610+00.000	64.81	0.0123	2010-2014: 1,800	12.00	12.00	8.00	8.00	0.00	0.3	1	false	1	false	false	false	1,041.74	2.0	true	60
50	2U	1610+00.000	1614+65.403	465.40	0.0881	2010-2014: 1,800	12.00	12.00	8.00	8.00	0.00	0.3	1	false	0	false	false	false	1,041.74	2.0	true	60
51	2U	1614+65.403	1615+65.837	100.43	0.0190	2010-2014: 1,800	12.00	12.00	8.00	8.00	0.00	0.3	1	false	0	false	false	false				
52	2U	1615+65.837	1623+55.342	789.50	0.1495	2010-2014: 1,800	12.00	12.00	8.00	8.00	0.00	0.3	1	false	0	false	false	false				
53	2U	1623+55.342	1627+06.536	351.19	0.0665	2010-2014: 1,800	12.00	12.00	8.00	8.00	0.00	0.3	1	false	0	false	false	false	3,819.72	2.0	true	60
54	2U	1627+06.536	1634+67.324	760.79	0.1441	2010-2014: 1,800	12.00	12.00	8.00	8.00	0.00	0.3	1	false	0	false	false	false	3,819.72	2.0	true	60
55	2U	1634+67.324	1643+43.433	876.11	0.1659	2010-2014: 1,800	12.00	12.00	8.00	8.00	0.00	0.3	1	false	0	false	false	false				
56	2U	1643+43.433	1658+40.396	1,496.96	0.2835	2010-2014: 1,800	12.00	12.00	8.00	8.00	0.00	0.3	1	false	0	false	false	false	2,546.48	2.0	true	60
57	2U	1658+40.396	1662+05.617	365.22	0.0692	2010-2014: 1,800	12.00	12.00	8.00	8.00	0.00	0.3	1	false	0	false	false	false	2,546.48	2.0	true	60
58	2U	1662+05.617	1671+65.038	959.42	0.1817	2010-2014: 1,800	12.00	12.00	8.00	8.00	0.00	0.3	1	false	0	false	false	false				
59	2U	1671+65.038	1674+56.874	291.84	0.0553	2010-2014: 1,800	12.00	12.00	8.00	8.00	0.00	0.3	1	false	0	false	false	false				
60	2U	1674+56.874	1681+00.000	643.13	0.1218	2010-2014: 1,800	12.00	12.00	8.00	8.00	0.00	0.3	1	false	0	false	false	false	2,864.79	2.0	true	60

Seg. No.	Type	Start Location	End Location	Length (ft)	Length (mi)	AADT	Left Lane Width (ft)	Right Lane Width (ft)	Left Shoulder Width (ft)	Right Shoulder Width (ft)	Grade (%)	Driveway Density (driveways/mi)	Hazard Rating	Centerline Rumble Strip	Passing Lanes	TW LT Lane	Lighting	Automated Speed Enforcement	Radius (ft)	Superelevation (%)	Adverse	Design Speed (mph)
61	2U	1681+00.00	1684+84.121	384.12	0.0727	2010-2014: 1,800	12.00	12.00	8.00	8.00	0.00	0.3	1	false	1	false	false	false	2,864.79	2.0	true	60
62	2U	1684+84.121	1689+55.548	471.43	0.0893	2010-2014: 1,800	12.00	12.00	8.00	8.00	0.00	0.3	1	false	1	false	false	false				
63	2U	1689+55.548	1696+91.231	735.68	0.1393	2010-2014: 1,800	12.00	12.00	8.00	8.00	0.00	0.3	1	false	1	false	false	false	2,291.83	2.0	true	60
64	2U	1696+91.231	1697+38.184	46.95	0.0089	2010-2014: 1,800	12.00	12.00	8.00	8.00	0.00	0.3	1	false	1	false	false	false	2,291.83	2.0	true	60
65	2U	1697+38.184	1703+52.875	614.69	0.1164	2010-2014: 1,800	12.00	12.00	8.00	8.00	0.00	0.3	1	false	1	false	false	false				
66	2U	1703+52.875	1708+54.649	501.77	0.0950	2010-2014: 1,800	12.00	12.00	8.00	8.00	0.00	0.3	1	false	1	false	false	false	3,819.72	2.0	true	60
67	2U	1708+54.649	1713+92.335	537.69	0.1018	2010-2014: 1,800	12.00	12.00	8.00	8.00	0.00	0.3	1	false	1	false	false	false	3,819.72	2.0	true	60
68	2U	1713+92.335	1716+89.463	297.13	0.0563	2010-2014: 1,800	12.00	12.00	8.00	8.00	0.00	0.3	1	false	1	false	false	false				
69	2U	1716+89.463	1728+08.381	1,118.9	0.2119	2010-2014: 1,800	12.00	12.00	8.00	8.00	0.00	0.3	1	false	1	false	false	false				
70	2U	1728+08.381	1731+17.025	308.64	0.0585	2010-2014: 1,800	12.00	12.00	8.00	8.00	0.00	0.3	1	false	1	false	false	false				
71	2U	1731+17.025	1736+82.212	565.19	0.1070	2010-2014: 1,800	12.00	12.00	8.00	8.00	0.00	0.3	1	false	1	false	false	false	2,150.00	2.0	true	60
72	2U	1736+82.212	1739+00.000	217.79	0.0413	2010-2014: 1,800	12.00	12.00	8.00	8.00	0.00	0.3	1	false	1	false	false	false				
73	2U	1739+00.000	1749+79.705	1,079.70	0.2045	2010-2014: 1,800	12.00	12.00	8.00	8.00	0.00	0.3	1	false	0	false	false	false				
74	2U	1749+79.705	1750+54.678	74.97	0.0142	2010-2014: 1,800	12.00	12.00	8.00	8.00	0.00	0.3	1	false	0	false	false	false	1,950.00	2.0	true	60
75	2U	1750+54.678	1754+00.000	345.32	0.0654	2010-2014: 1,800	12.00	12.00	8.00	8.00	0.00	0.3	1	false	0	false	false	false	1,950.00	2.0	true	60
76	2U	1754+00.000	1756+47.361	247.36	0.0469	2010-2014: 1,800	12.00	12.00	8.00	8.00	0.00	0.3	1	false	1	false	false	false	1,950.00	2.0	true	60
77	2U	1756+47.361	1761+94.171	546.81	0.1036	2010-2014: 1,800	12.00	12.00	8.00	8.00	0.00	0.3	1	false	1	false	false	false				
78	2U	1761+94.171	1764+68.438	274.27	0.0519	2010-2014: 1,800	12.00	12.00	8.00	8.00	0.00	0.3	1	false	1	false	false	false	5,800.00	2.0	true	60
79	2U	1764+68.438	1769+37.986	469.55	0.0889	2010-2014: 1,800	12.00	12.00	8.00	8.00	0.00	0.3	1	false	1	false	false	false	5,800.00	2.0	true	60
80	2U	1769+37.986	1786+03.032	1,665.05	0.3154	2010-2014: 1,800	12.00	12.00	8.00	8.00	0.00	0.3	1	false	1	false	false	false				
81	2U	1786+03.032	1796+26.415	1,023.38	0.1938	2010-2014: 1,800	12.00	12.00	8.00	8.00	0.00	0.3	1	false	1	false	false	false				
82	2U	1796+26.415	1801+11.457	485.04	0.0919	2010-2014: 1,800	12.00	12.00	8.00	8.00	0.00	0.3	1	false	1	false	false	false	5,729.58	2.0	true	60
83	2U	1801+11.457	1803+66.390	254.93	0.0483	2010-2014: 1,800	12.00	12.00	8.00	8.00	0.00	0.3	1	false	1	false	false	false				
84	2U	1803+66.390	1814+09.517	1,043.13	0.1976	2010-2014: 1,800	12.00	12.00	8.00	8.00	0.00	0.3	1	false	1	false	false	false				
85	2U	1814+09.517	1819+97.464	587.95	0.1114	2010-2014: 1,800	12.00	12.00	8.00	8.00	0.00	0.3	1	false	1	false	false	false	1,450.00	2.0	true	60
86	2U	1819+97.464	1820+48.062	50.60	0.0096	2010-2014: 1,800	12.00	12.00	8.00	8.00	0.00	0.3	1	false	1	false	false	false				

Seg. No.	Type	Start Location	End Location	Length (ft)	Length (mi)	AADT	Left Lane Width (ft)	Right Lane Width (ft)	Left Shoulder Width (ft)	Right Shoulder Width (ft)	Grade (%)	Driveway Density (driveways/mi)	Hazard Rating	Centerline Rumble Strip	Passing Lanes	TW LT Lane	Lighting	Automated Speed Enforcement	Radius (ft)	Superelevation (%)	Adverse	Design Speed (mph)
87	2U	1820+48.062	1824+53.898	405.84	0.0769	2010-2014: 1,800	12.00	12.00	8.00	8.00	0.00	0.3	1	false	1	false	false	false				
88	2U	1824+53.898	1826+89.465	235.57	0.0446	2010-2014: 1,800	12.00	12.00	8.00	8.00	0.00	0.3	1	false	1	false	false	false	3,000.00	2.0	true	60
89	2U	1826+89.465	1830+41.880	352.42	0.0668	2010-2014: 1,800	12.00	12.00	8.00	8.00	0.00	0.3	1	false	1	false	false	false	3,000.00	2.0	true	60
90	2U	1830+41.880	1836+58.064	616.18	0.1167	2010-2014: 1,800	12.00	12.00	8.00	8.00	0.00	0.3	1	false	1	false	false	false				
91	2U	1836+58.064	1841+90.386	532.32	0.1008	2010-2014: 1,800	12.00	12.00	8.00	8.00	0.00	0.3	1	false	1	false	false	false	1,160.00	2.0	true	60
92	2U	1841+90.386	1844+74.496	284.11	0.0538	2010-2014: 1,800	12.00	12.00	8.00	8.00	0.00	0.3	1	false	1	false	false	false	1,160.00	2.0	true	60
93	2U	1844+74.496	1849+15.104	440.61	0.0834	2010-2014: 1,800	12.00	12.00	8.00	8.00	0.00	0.3	1	false	1	false	false	false				
94	2U	1849+15.104	1858+04.945	889.84	0.1685	2010-2014: 1,800	12.00	12.00	8.00	8.00	0.00	0.3	1	false	1	false	false	false	825.00	2.0	true	60
95	2U	1858+04.945	1869+49.895	1,144.95	0.2168	2010-2014: 1,800	12.00	12.00	8.00	8.00	0.00	0.3	1	false	1	false	false	false				
96	2U	1869+49.895	1875+20.742	570.85	0.1081	2010-2014: 1,800	12.00	12.00	8.00	8.00	0.00	0.3	1	false	1	false	false	false	1,909.86	2.0	true	60
97	2U	1875+20.742	1887+50.279	1,229.54	0.2329	2010-2014: 1,800	12.00	12.00	8.00	8.00	0.00	0.3	1	false	1	false	false	false				
98	2U	1887+50.279	1899+00.000	1,149.72	0.2177	2010-2014: 1,800	12.00	12.00	8.00	8.00	0.00	0.3	1	false	1	false	false	false				
99	2U	1899+00.000	1902+52.815	352.81	0.0668	2010-2014: 1,800	12.00	12.00	8.00	8.00	0.00	0.3	1	false	0	false	false	false				
100	2U	1902+52.815	1908+15.543	562.73	0.1066	2010-2014: 1,800	12.00	12.00	8.00	8.00	0.00	0.3	1	false	0	false	false	false	1,980.00	2.0	true	60
101	2U	1908+15.543	1912+56.122	440.58	0.0834	2010-2014: 1,800	12.00	12.00	8.00	8.00	0.00	0.3	1	false	0	false	false	false				
102	2U	1912+56.122	1922+09.301	953.18	0.1805	2010-2014: 1,800	12.00	12.00	8.00	8.00	0.00	0.3	1	false	0	false	false	false	1,909.86	2.0	true	60
103	2U	1922+09.301	1923+07.672	98.37	0.0186	2010-2014: 1,800	12.00	12.00	8.00	8.00	0.00	0.3	1	false	0	false	false	false	1,909.86	2.0	true	60
104	2U	1923+07.672	1942+90.110	1,982.44	0.3755	2010-2014: 1,800	12.00	12.00	8.00	8.00	0.00	0.3	1	false	0	false	false	false				
105	2U	1942+90.110	1951+68.332	878.22	0.1663	2010-2014: 1,800	12.00	12.00	8.00	8.00	0.00	0.3	1	false	0	false	false	false				
106	2U	1951+68.332	1991+05.968	3,937.64	0.7458	2010-2014: 1,800	12.00	12.00	8.00	8.00	0.00	0.3	1	false	0	false	false	false				
107	2U	1991+05.968	2014+85.473	2,379.51	0.4507	2010-2014: 1,800	12.00	12.00	8.00	8.00	0.00	0.3	1	false	0	false	false	false				
108	2U	2014+85.473	2044+63.612	2,978.14	0.5640	2010-2014: 1,800	12.00	12.00	8.00	8.00	0.00	0.3	1	false	0	false	false	false				
109	2U	2044+63.612	2061+78.629	1,715.02	0.3248	2010-2014: 1,800	12.00	12.00	8.00	8.00	0.00	0.3	1	false	0	false	false	false				
110	2U	2061+78.629	2070+98.406	919.78	0.1742	2010-2014: 1,800	12.00	12.00	8.00	8.00	0.00	0.3	1	false	0	false	false	false				
111	2U	2070+98.406	2084+39.972	1,341.57	0.2541	2010-2014: 1,800	12.00	12.00	8.00	8.00	0.00	0.3	1	false	0	false	false	false	5,729.58	2.0	true	60
112	2U	2084+39.972	2086+40.102	200.13	0.0379	2010-2014: 1,800	12.00	12.00	8.00	8.00	0.00	0.3	1	false	0	false	false	false	5,729.58	2.0	true	60



Seg. No.	Type	Start Location	End Location	Length (ft)	Length (mi)	AADT	Left Lane Width (ft)	Right Lane Width (ft)	Left Shoulder Width (ft)	Right Shoulder Width (ft)	Grade (%)	Driveway Density (driveways/mi)	Hazard Rating	Centerline Rumble Strip	Passing Lanes	TW LT Lane	Lighting	Automated Speed Enforcement	Radius (ft)	Superelevation (%)	Adverse	Design Speed (mph)
113	2U	2086+40.102	2099+74.790	1,334.69	0.2528	2010-2014: 1,800	12.00	12.00	8.00	8.00	0.00	0.3	1	false	0	false	false	false				
114	2U	2099+74.790	2111+43.919	1,169.13	0.2214	2010-2014: 1,800	12.00	12.00	8.00	8.00	0.00	0.3	1	false	0	false	false	false				
115	2U	2111+43.919	2120+81.651	937.73	0.1776	2010-2014: 1,800	12.00	12.00	8.00	8.00	0.00	0.3	1	false	0	false	false	false				
116	2U	2120+81.651	2129+87.830	906.18	0.1716	2010-2014: 1,800	12.00	12.00	8.00	8.00	0.00	0.3	1	false	0	false	false	false				
117	2U	2129+87.830	2140+56.643	1,068.81	0.2024	2010-2014: 1,800	12.00	12.00	8.00	8.00	0.00	0.3	1	false	0	false	false	false				
118	2U	2140+56.643	2142+74.256	217.61	0.0412	2010-2014: 1,800	12.00	12.00	8.00	8.00	0.00	0.3	1	false	0	false	false	false	5,729.58	2.0	true	60
119	2U	2142+74.256	2168+08.627	2,534.37	0.4800	2010-2014: 1,800	12.00	12.00	8.00	8.00	0.00	0.3	1	false	0	false	false	false	5,729.58	2.0	true	60
120	2U	2168+08.627	2182+78.204	1,469.58	0.2783	2010-2014: 1,800	12.00	12.00	8.00	8.00	0.00	0.3	1	false	0	false	false	false	5,729.58	2.0	true	60
121	2U	2182+78.204	2183+26.113	47.91	0.0091	2010-2014: 1,800	12.00	12.00	8.00	8.00	0.00	0.3	1	false	0	false	false	false	5,729.58	2.0	true	60
122	2U	2183+26.113	2199+41.672	1,615.56	0.3060	2010-2014: 1,800	12.00	12.00	8.00	8.00	0.00	0.3	1	false	0	false	false	false				
123	2U	2199+41.672	2201+13.109	171.44	0.0325	2010-2014: 1,800	12.00	12.00	8.00	8.00	0.00	0.3	1	false	0	false	false	false				
124	2U	2201+13.109	2210+46.999	933.89	0.1769	2010-2014: 1,800	12.00	12.00	8.00	8.00	0.00	0.3	1	false	0	false	false	false	2,864.79	2.0	true	60
125	2U	2210+46.999	2224+50.778	1,403.78	0.2659	2010-2014: 1,800	12.00	12.00	8.00	8.00	0.00	0.3	1	false	0	false	false	false				
126	2U	2224+50.778	2238+41.687	1,390.91	0.2634	2010-2014: 1,800	12.00	12.00	8.00	8.00	0.00	0.3	1	false	0	false	false	false				
127	2U	2238+41.687	2252+38.958	1,397.27	0.2646	2010-2014: 1,800	12.00	12.00	8.00	8.00	0.00	0.3	1	false	0	false	false	false				
128	2U	2252+38.958	2253+13.131	74.17	0.0140	2010-2014: 1,800	12.00	12.00	8.00	8.00	0.00	0.3	1	false	0	false	false	false	2,788.71	2.0	true	60
129	2U	2253+13.131	2267+68.359	1,455.23	0.2756	2010-2014: 1,800	12.00	12.00	8.00	8.00	0.00	0.3	1	false	0	false	false	false	2,788.71	2.0	true	60
130	2U	2267+68.359	2271+18.026	349.67	0.0662	2010-2014: 1,800	12.00	12.00	8.00	8.00	0.00	0.3	1	false	0	false	false	false				
131	2U	2271+18.026	2275+17.825	399.80	0.0757	2010-2014: 1,800	12.00	12.00	8.00	8.00	0.00	0.3	1	false	0	false	false	false				
132	2U	2275+17.825	2283+86.397	868.57	0.1645	2010-2014: 1,800	12.00	12.00	8.00	8.00	0.00	0.3	1	false	0	false	false	false	2,788.71	2.0	true	60
133	2U	2283+86.397	2294+34.169	1,047.77	0.1984	2010-2014: 1,800	12.00	12.00	8.00	8.00	0.00	0.3	1	false	0	false	false	false	2,788.71	2.0	true	60
134	2U	2294+34.169	2297+86.147	351.98	0.0667	2010-2014: 1,800	12.00	12.00	8.00	8.00	0.00	0.3	1	false	0	false	false	false	2,788.71	2.0	true	60
135	2U	2297+86.147	2322+20.021	2,433.87	0.4610	2010-2014: 1,800	12.00	12.00	8.00	8.00	0.00	0.3	1	false	0	false	false	false				
136	2U	2322+20.021	2324+46.955	226.93	0.0430	2010-2014: 1,800	12.00	12.00	8.00	8.00	0.00	0.3	1	false	0	false	false	false				
137	2U	2324+46.955	2328+02.518	355.56	0.0673	2010-2014: 1,800	12.00	12.00	8.00	8.00	0.00	0.3	1	false	0	false	false	false	2,864.09	2.0	true	60
138	2U	2328+02.518	2335+97.505	794.99	0.1506	2010-2014: 1,800	12.00	12.00	8.00	8.00	0.00	0.3	1	false	0	false	false	false	2,864.09	2.0	true	60

Seg. No.	Type	Start Location	End Location	Length (ft)	Length (mi)	AADT	Left Lane Width (ft)	Right Lane Width (ft)	Left Shoulder Width (ft)	Right Shoulder Width (ft)	Grade (%)	Driveway Density (driveways/mi)	Hazard Rating	Centerline Rumble Strip	Passing Lanes	TW LT Lane	Lighting	Automated Speed Enforcement	Radius (ft)	Superelevation (%)	Adverse	Design Speed (mph)
139	2U	2335+97.505	2358+28.150	2,230.64	0.4225	2010-2014: 1,800	12.00	12.00	8.00	8.00	0.00	0.3	1	false	0	false	false	false				
140	2U	2358+28.150	2388+01.647	2,973.50	0.5632	2010-2014: 1,800	12.00	12.00	8.00	8.00	0.00	0.3	1	false	0	false	false	false				
141	2U	2388+01.647	2392+62.777	461.13	0.0873	2010-2014: 1,800	12.00	12.00	8.00	8.00	0.00	0.3	1	false	0	false	false	false	1,909.86	2.0	true	60
142	2U	2392+62.777	2393+97.841	135.06	0.0256	2010-2014: 1,800	12.00	12.00	8.00	8.00	0.00	0.3	1	false	0	false	false	false	1,909.86	2.0	true	60
143	2U	2393+97.841	2399+08.519	510.68	0.0967	2010-2014: 1,800	12.00	12.00	8.00	8.00	0.00	0.3	1	false	0	false	false	false				
144	2U	2399+08.519	2406+75.288	766.77	0.1452	2010-2014: 1,800	12.00	12.00	8.00	8.00	0.00	0.3	1	false	0	false	false	false	1,145.92	2.0	true	60
145	2U	2406+75.288	2410+56.262	380.97	0.0722	2010-2014: 1,800	12.00	12.00	8.00	8.00	0.00	0.3	1	false	0	false	false	false	1,145.92	2.0	true	60
146	2U	2410+56.262	2413+31.488	275.23	0.0521	2010-2014: 1,800	12.00	12.00	8.00	8.00	0.00	0.3	1	false	0	false	false	false				
147	2U	2413+31.488	2415+67.769	236.28	0.0447	2010-2014: 1,800	12.00	12.00	8.00	8.00	0.00	0.3	1	false	0	false	false	false				
148	2U	2415+67.769	2417+66.491	198.72	0.0376	2010-2014: 1,800	12.00	12.00	8.00	8.00	0.00	0.3	1	false	0	false	false	false	1,145.91	2.0	true	60
149	2U	2417+66.491	2419+57.000	190.51	0.0361	2010-2014: 1,800	12.00	12.00	8.00	8.00	0.00	0.3	1	false	0	false	false	false	1,145.91	2.0	true	60
150	2U	2419+57.000	2424+37.323	480.32	0.0910	2010-2014: 1,800	12.00	12.00	8.00	8.00	0.00	0.3	1	false	0	false	false	false	1,145.91	2.0	true	60

**Table 4. Expected Highway Crash Rates and Frequencies (Section 1)**

<b>First Year of Analysis</b>	2017
<b>Last Year of Analysis</b>	2017
<b>Evaluated Length (mi)</b>	20.7820
<b>Average Future Road AADT (vpd)</b>	1,800
<b>Expected Crashes</b>	
<b>Total Crashes</b>	7.98
<b>Fatal and Injury Crashes</b>	2.72
<b>Property-Damage-Only Crashes</b>	5.25
<b>Percent of Total Expected Crashes</b>	
<b>Percent Fatal and Injury Crashes (%)</b>	34
<b>Percent Property-Damage-Only Crashes (%)</b>	66
<b>Expected Crash Rate</b>	
<b>Crash Rate (crashes/mi/yr)</b>	0.3838
<b>Fatal and Injury Crash Rate (crashes/mi/yr)</b>	0.1310
<b>Property-Damage-Only Crash Rate (crashes/mi/yr)</b>	0.2528
<b>Expected Travel Crash Rate</b>	
<b>Total Travel (million veh-mi)</b>	13.65
<b>Travel Crash Rate (crashes/million veh-mi)</b>	0.58
<b>Travel Fatal and Injury Crash Rate (crashes/million veh-mi)</b>	0.20
<b>Travel Property-Damage-Only Crash Rate (crashes/million veh-mi)</b>	0.39

**Table 5. Expected Crash Frequencies and Rates by Highway Segment (Section 1)**

<b>Segment Number/Intersection Name/Cross Road</b>	<b>Start Location</b>	<b>End Location</b>	<b>Length (mi)</b>	<b>Expected No. Crashes for Evaluation Period</b>	<b>Crash Rate (crashes/mi/yr)</b>	<b>Travel Crash Rate (crashes/million veh-mi)</b>
1	0.000	1336+44.302(1)	0.1771	0.048	0.2683	0.41
2	1336+44.302(1)	1345+88.891(1)	0.1789	0.059	0.3295	0.50
3	1345+88.891(1)	1350+43.605(1)	0.0861	0.023	0.2683	0.41
4	1350+43.605(1)	1355+75.006(1)	0.1006	0.037	0.3717	0.57
5	1355+75.006(1)	1359+98.149(1)	0.0801	0.021	0.2683	0.41
6	1359+98.149(1)	1375+23.561(1)	0.2889	0.093	0.3223	0.49
7	1375+23.561(1)	1393+00.000(1)	0.3364	0.090	0.2683	0.41
8	1393+00.000(1)	1400+30.565(1)	0.1384	0.037	0.2683	0.41
9	1400+30.565(1)	1409+13.059(1)	0.1671	0.045	0.2683	0.41
10	1409+13.059(1)	1414+04.404(1)	0.0931	0.031	0.3328	0.51

Segment Number/Intersection Name/Cross Road	Start Location	End Location	Length (mi)	Expected No. Crashes for Evaluation Period	Crash Rate (crashes/mi/yr)	Travel Crash Rate (crashes/million veh-mi)
11	1414+04.404(1)	1421+34.750(1)	0.1383	0.050	0.3645	0.56
12	1421+34.750(1)	1429+14.713(1)	0.1477	0.044	0.2952	0.45
13	1429+14.713(1)	1429+71.777(1)	0.0108	0.004	0.3985	0.61
14	1429+71.777(1)	1439+70.699(1)	0.1892	0.063	0.3334	0.51
15	1439+70.699(1)	1446+51.376(1)	0.1289	0.037	0.2836	0.43
16	1446+51.376(1)	1449+40.000(1)	0.0547	0.018	0.3206	0.49
17	1449+40.000(1)	1451+33.375(1)	0.0366	0.009	0.2404	0.37
18	1451+33.375(1)	1461+98.062(1)	0.2016	0.053	0.2607	0.40
19	1461+98.062(1)	1467+73.811(1)	0.1090	0.024	0.2154	0.33
20	1467+73.811(1)	1475+38.715(1)	0.1449	0.039	0.2689	0.41
21	1475+38.715(1)	1478+43.352(1)	0.0577	0.028	0.4812	0.73
22	1478+43.352(1)	1483+12.985(1)	0.0889	0.063	0.7097	1.08
23	1483+12.985(1)	1496+61.507(1)	0.2554	0.070	0.2753	0.42
24	1496+61.507(1)	1505+09.701(1)	0.1606	0.041	0.2572	0.39
25	1505+09.701(1)	1507+88.933(1)	0.0529	0.011	0.2051	0.31
26	1507+88.933(1)	1518+44.144(1)	0.1999	0.110	0.5513	0.84
27	1518+44.144(1)	1520+94.599(1)	0.0474	0.039	0.8288	1.26
28	1520+94.599(1)	1523+64.397(1)	0.0511	0.030	0.5876	0.89
29	1523+64.397(1)	1548+64.398(1)	0.4735	0.126	0.2654	0.40
30	1548+64.398(1)	1552+17.143(1)	0.0668	0.015	0.2214	0.34
31	1552+17.143(1)	1556+63.827(1)	0.0846	0.019	0.2283	0.35
32	1556+63.827(1)	1570+18.580(1)	0.2566	0.079	0.3060	0.47
33	1570+18.580(1)	1581+42.155(1)	0.2128	0.057	0.2690	0.41
34	1581+42.155(1)	1600+40.495(1)	0.3595	0.152	0.4233	0.64
35	1600+40.495(1)	1602+30.336(1)	0.0360	0.008	0.2104	0.32
36	1602+30.336(1)	1610+70.100(1)	0.1590	0.044	0.2779	0.42
37	1610+70.100(1)	1621+46.738(1)	0.2039	0.052	0.2554	0.39
38	1621+46.738(1)	1625+90.000(1)	0.0840	0.018	0.2128	0.32
39	1625+90.000(1)	1633+46.402(1)	0.1433	0.093	0.6521	0.99
40	1633+46.402(1)	1649+14.793(1)	0.2970	0.247	0.8306	1.26
41	1649+14.793(1)	1652+11.160(1)	0.0561	0.033	0.5905	0.90
42	1652+11.160(1)	1661+79.000(1)	0.1833	0.070	0.3808	0.58
43	1661+79.000(1)	1664+36.565(1)	0.0488	0.008	0.1729	0.26
44	1664+36.565(1)	1675+12.295(1)	0.2037	0.110	0.5394	0.82
45	1675+12.295(1)	1678+20.135(1)	0.0583	0.045	0.7745	1.18
46	1678+20.135(1)	1688+79.987(1)	0.2007	0.090	0.4491	0.68
47	1688+79.987(1)	1693+40.960(1)	0.0873	0.079	0.9023	1.37
48	1693+40.960(1)	1695+70.734(1)	0.0435	0.058	1.3330	2.03
49	1695+70.734(1)	1704+03.820(1)	0.1578	0.138	0.8737	1.33
50	1704+03.820(1)	1706+93.795(1)	0.0549	0.037	0.6810	1.04
51	1706+93.795(1)	1718+16.939(1)	0.2127	0.052	0.2457	0.37
52	1718+16.939(1)	1718+73.301(1)	0.0107	0.002	0.2084	0.32
53	1718+73.301(1)	1729+24.812(1)	0.1991	0.053	0.2658	0.40
54	1729+24.812(1)	1738+90.122(1)	0.1828	0.036	0.1945	0.30
55	1738+90.122(1)	1739+01.335(1)	0.0021	0.001	0.2880	0.44
56	1739+01.335(1)	1749+60.945(1)	0.2007	0.100	0.4969	0.76
57	1749+60.945(1)	1753+37.825(1)	0.0714	0.012	0.1628	0.25
58	1753+37.825(1)	1756+19.308(1)	0.0533	0.010	0.1932	0.29
59	1756+19.308(1)	1763+99.822(1)	0.1478	0.035	0.2403	0.37
60	1763+99.822(1)	1773+79.000(1)	0.1855	0.037	0.2023	0.31

Segment Number/Intersection Name/Cross Road	Start Location	End Location	Length (mi)	Expected No. Crashes for Evaluation Period	Crash Rate (crashes/mi/yr)	Travel Crash Rate (crashes/million veh-mi)
61	1773+79.000(1)	1776+44.892(1)	0.0504	0.016	0.3206	0.49
62	1776+44.892(1)	1783+38.648(1)	0.1314	0.038	0.2914	0.44
63	1783+38.648(1)	1793+15.024(1)	0.1849	0.062	0.3348	0.51
64	1793+15.024(1)	1793+95.145(1)	0.0152	0.006	0.3683	0.56
65	1793+95.145(1)	1806+14.814(1)	0.2310	0.090	0.3904	0.59
66	1806+14.814(1)	1806+82.524(1)	0.0128	0.009	0.7035	1.07
67	1806+82.524(1)	1818+59.631(1)	0.2229	0.165	0.7394	1.12
68	1818+59.631(1)	1819+02.306(1)	0.0081	0.003	0.3769	0.57
69	1819+02.306(1)	1837+08.045(1)	0.3420	0.181	0.5290	0.81
70	1837+08.045(1)	1837+12.472(1)	0.0008	0.000	0.2777	0.42
71	1837+12.472(1)	1852+14.359(1)	0.2844	0.111	0.3902	0.59
72	1852+14.359(1)	1855+90.269(1)	0.0712	0.019	0.2714	0.41
73	1855+90.269(1)	1866+66.290(1)	0.2038	0.082	0.4005	0.61
74	1866+66.290(1)	1872+40.458(1)	0.1087	0.067	0.6112	0.93
75	1872+40.458(1)	1884+00.000(1)	0.2196	0.101	0.4602	0.70
76	1884+00.000(1)	1887+17.885(1)	0.0602	0.013	0.2084	0.32
77	1887+17.885(1)	1897+69.447(1)	0.1992	0.110	0.5503	0.84
78	1897+69.447(1)	1900+15.731(1)	0.0466	0.015	0.3211	0.49
79	1900+15.731(1)	1911+44.501(1)	0.2138	0.153	0.7172	1.09
80	1911+44.501(1)	1914+69.648(1)	0.0616	0.022	0.3656	0.56
81	1914+69.648(1)	1935+13.440(1)	0.3871	0.064	0.1665	0.25
82	1935+13.440(1)	1942+14.172(1)	0.1327	0.025	0.1919	0.29
83	1942+14.172(1)	1979+48.414(1)	0.7072	0.252	0.3559	0.54
84	1979+48.414(1)	1990+96.000(1)	0.2173	0.081	0.3740	0.57
85	1990+96.000(1)	2004+08.375(1)	0.2486	0.074	0.2975	0.45
86	2004+08.375(1)	2032+26.622(1)	0.5338	0.158	0.2952	0.45
87	2032+26.622(1)	2059+91.129(1)	0.5236	0.141	0.2683	0.41
88	2059+91.129(1)	2073+83.086(1)	0.2636	0.084	0.3179	0.48
89	2073+83.086(1)	2075+32.995(1)	0.0284	0.009	0.3042	0.46
90	2075+32.995(1)	2088+98.505(1)	0.2586	0.066	0.2566	0.39
91	2088+98.505(1)	2107+64.701(1)	0.3534	0.138	0.3893	0.59
92	2107+64.701(1)	2118+80.968(1)	0.2114	0.127	0.6009	0.92
93	2118+80.968(1)	2127+46.000(1)	0.1638	0.058	0.3514	0.54
94	2127+46.000(1)	2129+49.536(1)	0.0385	0.007	0.1744	0.27
95	2129+49.536(1)	2132+09.424(1)	0.0492	0.010	0.2049	0.31
96	2132+09.424(1)	2156+63.518(1)	0.4648	0.092	0.1986	0.30
97	2156+63.518(1)	2172+19.006(1)	0.2946	0.058	0.1953	0.30
98	2172+19.006(1)	2172+26.614(1)	0.0014	0.000	0.1662	0.25
99	2172+26.614(1)	2188+12.331(1)	0.3003	0.097	0.3215	0.49
100	2188+12.331(1)	2189+34.430(1)	0.0231	0.013	0.5780	0.88
101	2189+34.430(1)	2200+10.193(1)	0.2037	0.147	0.7237	1.10
102	2200+10.193(1)	2212+68.167(1)	0.2383	0.045	0.1896	0.29
103	2212+68.167(1)	2227+11.813(1)	0.2734	0.090	0.3295	0.50
104	2227+11.813(1)	2230+62.000(1)	0.0663	0.022	0.3307	0.50
105	2230+62.000(1)	2241+30.583(1)	0.2024	0.090	0.4439	0.68
106	2241+30.583(1)	2242+42.790(1)	0.0213	0.007	0.3506	0.53
107	2242+42.790(1)	2256+59.979(1)	0.2684	0.092	0.3423	0.52
108	2256+59.979(1)	2259+05.408(1)	0.0465	0.011	0.2469	0.38
109	2259+05.408(1)	2264+09.452(1)	0.0955	0.026	0.2716	0.41
110	2264+09.452(1)	2272+06.202(1)	0.1509	0.055	0.3645	0.56

Segment Number/Intersection Name/Cross Road	Start Location	End Location	Length (mi)	Expected No. Crashes for Evaluation Period	Crash Rate (crashes/mi/yr)	Travel Crash Rate (crashes/million veh-mi)
111	2272+06.202(1)	2286+77.767(1)	0.2787	0.090	0.3239	0.49
112	2286+77.767(1)	2313+38.578(1)	0.5039	0.212	0.4204	0.64
113	2313+38.578(1)	2324+89.129(1)	0.2179	0.147	0.6770	1.03
114	2324+89.129(1)	2376+93.270(1)	0.9856	0.448	0.4546	0.69
115	2376+93.270(1)	2381+06.049(1)	0.0782	0.059	0.7584	1.15
116	2381+06.049(1)	2382+89.464(1)	0.0347	0.026	0.7584	1.15
117	2382+89.464(1)	2388+00.142(1)	0.0967	0.048	0.4933	0.75
118	2388+00.142(1)	2392+46.808(1)	0.0846	0.108	1.2738	1.94
119	2392+46.808(1)	2399+47.886(1)	0.1328	0.054	0.4088	0.62
120	2399+47.886(1)	2404+59.393(1)	0.0969	0.022	0.2318	0.35
121	2404+59.393(1)	2407+00.000(1)	0.0456	0.016	0.3512	0.54
122	2407+00.000(1)	2415+33.737(1)	0.1579	0.060	0.3829	0.58
123	2415+33.737(1)	2424+38.143(1)	0.1713	0.149	0.8679	1.32

Table 6. Expected Crash Frequencies and Rates by Horizontal Design Element (Section 1)

Title	Start Location	End Location	Length (mi)	Expected No. Crashes for Evaluation Period	Crash Rate (crashes/mi/yr)	Travel Crash Rate (crashes/million veh-mi)
Tangent	0.000	1336+44.302(1)	0.1771	0.048	0.2683	0.41
Simple Curve 1	1336+44.302(1)	1345+88.891(1)	0.1789	0.059	0.3295	0.50
Tangent	1345+88.891(1)	1350+43.605(1)	0.0861	0.023	0.2683	0.41
Simple Curve 2	1350+43.605(1)	1355+75.006(1)	0.1006	0.037	0.3717	0.57
Tangent	1355+75.006(1)	1359+98.149(1)	0.0801	0.021	0.2683	0.41
Simple Curve 3	1359+98.149(1)	1375+23.561(1)	0.2889	0.093	0.3223	0.49
Tangent	1375+23.561(1)	1409+13.059(1)	0.6420	0.172	0.2683	0.41
Simple Curve 4	1409+13.059(1)	1421+34.750(1)	0.2314	0.081	0.3517	0.54
Tangent	1421+34.750(1)	1429+14.713(1)	0.1477	0.044	0.2952	0.45
Simple Curve 5	1429+14.713(1)	1439+70.699(1)	0.2000	0.067	0.3369	0.51
Tangent	1439+70.699(1)	1451+33.375(1)	0.2202	0.063	0.2856	0.43
Simple Curve 6	1451+33.375(1)	1461+98.062(1)	0.2016	0.053	0.2607	0.40
Tangent	1461+98.062(1)	1467+73.811(1)	0.1090	0.024	0.2154	0.33
Simple Curve 7	1467+73.811(1)	1478+43.352(1)	0.2026	0.067	0.3294	0.50
Tangent	1478+43.352(1)	1483+12.985(1)	0.0889	0.063	0.7097	1.08
Simple Curve 8	1483+12.985(1)	1505+09.701(1)	0.4160	0.112	0.2683	0.41
Tangent	1505+09.701(1)	1507+88.933(1)	0.0529	0.011	0.2051	0.31
Simple Curve 9	1507+88.933(1)	1518+44.144(1)	0.1999	0.110	0.5513	0.84
Tangent	1518+44.144(1)	1523+64.397(1)	0.0985	0.069	0.7037	1.07
Simple Curve 10	1523+64.397(1)	1548+64.398(1)	0.4735	0.126	0.2654	0.40
Tangent	1548+64.398(1)	1556+63.827(1)	0.1514	0.034	0.2253	0.34
Simple Curve 11	1556+63.827(1)	1570+18.580(1)	0.2566	0.079	0.3060	0.47
Tangent	1570+18.580(1)	1581+42.155(1)	0.2128	0.057	0.2690	0.41
Simple Curve 12	1581+42.155(1)	1600+40.495(1)	0.3595	0.152	0.4233	0.64
Tangent	1600+40.495(1)	1602+30.336(1)	0.0360	0.008	0.2104	0.32
Simple Curve 13	1602+30.336(1)	1621+46.738(1)	0.3630	0.096	0.2653	0.40
Tangent	1621+46.738(1)	1633+46.402(1)	0.2272	0.111	0.4898	0.75

Title	Start Location	End Location	Length (mi)	Expected No. Crashes for Evaluation Period	Crash Rate (crashes/mi/yr)	Travel Crash Rate (crashes/million veh-mi)
Simple Curve 14	1633+46.402(1)	1652+11.160(1)	0.3532	0.280	0.7924	1.21
Tangent	1652+11.160(1)	1664+36.565(1)	0.2321	0.078	0.3371	0.51
Simple Curve 15	1664+36.565(1)	1675+12.295(1)	0.2037	0.110	0.5394	0.82
Tangent	1675+12.295(1)	1678+20.135(1)	0.0583	0.045	0.7745	1.18
Simple Curve 16	1678+20.135(1)	1688+79.987(1)	0.2007	0.090	0.4491	0.68
Tangent	1688+79.987(1)	1693+40.960(1)	0.0873	0.079	0.9023	1.37
Simple Curve 17	1693+40.960(1)	1704+03.820(1)	0.2013	0.196	0.9730	1.48
Tangent	1704+03.820(1)	1718+73.301(1)	0.2783	0.092	0.3302	0.50
Simple Curve 18	1718+73.301(1)	1729+24.812(1)	0.1991	0.053	0.2658	0.40
Tangent	1729+24.812(1)	1738+90.122(1)	0.1828	0.036	0.1945	0.30
Simple Curve 19	1738+90.122(1)	1749+60.945(1)	0.2028	0.100	0.4947	0.75
Tangent	1749+60.945(1)	1753+37.825(1)	0.0714	0.012	0.1628	0.25
Simple Curve 20	1753+37.825(1)	1763+99.822(1)	0.2011	0.046	0.2278	0.35
Tangent	1763+99.822(1)	1783+38.648(1)	0.3672	0.092	0.2504	0.38
Simple Curve 21	1783+38.648(1)	1793+95.145(1)	0.2001	0.068	0.3374	0.51
Tangent	1793+95.145(1)	1806+82.524(1)	0.2438	0.099	0.4069	0.62
Simple Curve 22	1806+82.524(1)	1819+02.306(1)	0.2310	0.168	0.7267	1.11
Tangent	1819+02.306(1)	1837+12.472(1)	0.3428	0.181	0.5283	0.80
Simple Curve 23	1837+12.472(1)	1852+14.359(1)	0.2844	0.111	0.3902	0.59
Tangent	1852+14.359(1)	1855+90.269(1)	0.0712	0.019	0.2714	0.41
Simple Curve 24	1855+90.269(1)	1866+66.290(1)	0.2038	0.082	0.4005	0.61
Tangent	1866+66.290(1)	1887+17.885(1)	0.3886	0.180	0.4634	0.70
Simple Curve 25	1887+17.885(1)	1897+69.447(1)	0.1992	0.110	0.5503	0.84
Tangent	1897+69.447(1)	1900+15.731(1)	0.0466	0.015	0.3211	0.49
Simple Curve 26	1900+15.731(1)	1911+44.501(1)	0.2138	0.153	0.7172	1.09
Tangent	1911+44.501(1)	2059+91.129(1)	2.8119	0.817	0.2907	0.44
Simple Curve 27	2059+91.129(1)	2075+32.995(1)	0.2920	0.092	0.3166	0.48
Tangent	2075+32.995(1)	2129+49.536(1)	1.0259	0.395	0.3853	0.59
Simple Curve 28	2129+49.536(1)	2172+19.006(1)	0.8086	0.160	0.1978	0.30
Tangent	2172+19.006(1)	2189+34.430(1)	0.3249	0.110	0.3390	0.52
Simple Curve 29	2189+34.430(1)	2200+10.193(1)	0.2037	0.147	0.7237	1.10
Tangent	2200+10.193(1)	2241+30.583(1)	0.7804	0.247	0.3166	0.48
Simple Curve 30	2241+30.583(1)	2256+59.979(1)	0.2897	0.099	0.3429	0.52
Tangent	2256+59.979(1)	2264+09.452(1)	0.1419	0.037	0.2635	0.40
Simple Curve 31	2264+09.452(1)	2286+77.767(1)	0.4296	0.145	0.3382	0.52
Tangent	2286+77.767(1)	2313+38.578(1)	0.5039	0.212	0.4204	0.64
Simple Curve 32	2313+38.578(1)	2324+89.129(1)	0.2179	0.147	0.6770	1.03
Tangent	2324+89.129(1)	2376+93.270(1)	0.9856	0.448	0.4546	0.69
Simple Curve 33	2376+93.270(1)	2382+89.464(1)	0.1129	0.086	0.7584	1.15
Tangent	2382+89.464(1)	2388+00.142(1)	0.0967	0.048	0.4933	0.75
Simple Curve 34	2388+00.142(1)	2399+47.886(1)	0.2174	0.162	0.7454	1.14
Tangent	2399+47.886(1)	2404+59.393(1)	0.0969	0.022	0.2318	0.35
Simple Curve 35	2404+59.393(1)	2415+33.737(1)	0.2035	0.076	0.3758	0.57
Tangent	2415+33.737(1)	2424+38.143(1)	0.1713	0.149	0.8679	1.32

**Table 7. Expected Segment Crash Type Distribution (Section 1)**

Element Type	Crash Type	FI Crashes	Percent FI (%)	PDO Crashes	Percent PDO (%)	Total Crashes	Percent Total (%)
Highway Segment	Collision with Animal	0.10	1.3	0.97	12.1	0.96	12.1
Highway Segment	Collision with Bicycle	0.01	0.1	0.01	0.1	0.02	0.2
Highway Segment	Other Single-vehicle Collision	0.02	0.2	0.15	1.9	0.17	2.1
Highway Segment	Overtaken	0.10	1.3	0.08	1.0	0.20	2.5
Highway Segment	Collision with Pedestrian	0.02	0.2	0.01	0.1	0.02	0.3
Highway Segment	Run Off Road	1.48	18.6	2.65	33.3	4.16	52.1
Highway Segment	Total Single Vehicle Crashes	1.74	21.8	3.86	48.4	5.53	69.3
Highway Segment	Angle Collision	0.28	3.4	0.38	4.7	0.68	8.5
Highway Segment	Head-on Collision	0.09	1.2	0.02	0.2	0.13	1.6
Highway Segment	Other Multiple-vehicle Collision	0.07	0.9	0.16	2.0	0.21	2.7
Highway Segment	Rear-end Collision	0.45	5.6	0.64	8.0	1.13	14.2
Highway Segment	Sideswipe	0.10	1.3	0.20	2.5	0.29	3.7
Highway Segment	Total Multiple Vehicle Crashes	0.99	12.4	1.39	17.5	2.45	30.7
Highway Segment	Total Highway Segment Crashes	2.73	34.2	5.25	65.9	7.98	100.0
	Total Crashes	2.73	34.2	5.25	65.9	7.98	100.0

**Note:** *Fatal and Injury Crashes* and *Property Damage Only Crashes* do not necessarily sum up to *Total Crashes* because the distribution of these three crashes had been derived independently.



## **Appendix D. IHSDM DCM Reports**

*Interactive Highway Safety Design Model*

**Design Consistency Evaluation Report**

**Existing Alignment**

January 24, 2018



## **Disclaimer**

The Interactive Highway Design Model (IHSDM) software is disseminated under the sponsorship of the Department of Transportation in the interest of information exchange. The United States Government assumes no liability for its content or use thereof. This document does not constitute a standard, specification, or regulation.

The United States Government does not endorse products or manufacturers. Trade and manufacturers' names may appear in this software and documentation only because they are considered essential to the objective of the software.

## **Limited Warranty and Limitations of Remedies**

This software product is provided "as-is," without warranty of any kind-either expressed or implied (but not limited to the implied warranties of merchantability and fitness for a particular purpose). The FHWA do not warrant that the functions contained in the software will meet the end-user's requirements or that the operation of the software will be uninterrupted and error-free.

Under no circumstances will the FHWA be liable to the end-user for any damages or claimed lost profits, lost savings, or other incidental or consequential damages rising out of the use or inability to use the software (even if these organizations have been advised of the possibility of such damages), or for any claim by any other party.

## **Notice**

The use of the IHSDM software is being done strictly on a voluntary basis. In exchange for provision of IHSDM, the user agrees that the Federal Highway Administration (FHWA), U.S. Department of Transportation and any other agency of the Federal Government shall not be responsible for any errors, damage or other liability that may result from any and all use of the software, including installation and testing of the software. The user further agrees to hold the FHWA and the Federal Government harmless from any resulting liability. The user agrees that this hold harmless provision shall flow to any person to whom or any entity to which the user provides the IHSDM software. It is the user's full responsibility to inform any person to whom or any entity to which it provides the IHSDM software of this hold harmless provision.

---

---

## Table of Contents

<b>Report Overview</b> .....	<b>1</b>
<b>Design Consistency Results, Increasing Stations</b> .....	<b>2</b>
<b>Design Consistency Results, Decreasing Stations</b> .....	<b>9</b>

## List of Tables

Table V85 Speed Profile Coordinates, Increasing Stations .....	4
Table Design Speed Assumption, Increasing Stations .....	6
Table Speed Differential of Adjacent Design Elements, Increasing Stations .....	8
Table V85 Speed Profile Coordinates, Decreasing Stations .....	11
Table Design Speed Assumption, Decreasing Stations .....	13
Table Speed Differential of Adjacent Design Elements, Decreasing Stations .....	15

## List of Figures

Figure Graphical Results, Increasing Stations .....	3
Figure Graphical Results, Decreasing Stations .....	10

## Report Overview

**Report Generated:** Jan 24, 2018 1:12 PM

**Report Template:** System: Single Page, by Travel Direction [System] (dcm5, Oct 9, 2017 1:45 PM)

**Evaluation Date:** Wed Jan 24 13:11:51 AKST 2018

**IHSDM Version:** v13.0.0 (Sep 13, 2017)

**Design Consistency Module:** v4.0.0 (Sep 23, 2016)

**User Name:** RaeAnne Hebnes

**Organization Name:** Michael Baker International

**Phone:**

**E-Mail:**

**Project Title:** Parks 305 - 325 v2

**Project Comment:** Created using wizard

**Project Unit System:** U.S. Customary

**Highway Title:** Alignment ParksHwy304-326 Asbuilt - 60 mph

**Highway Comment:** Created By Civil Geometry

**Highway Version:** 1

**Evaluation Title:** Evaluation 26

**Evaluation Comment:** Created Wed Jan 24 13:11:16 AKST 2018

**Minimum Station:** 1327+09.000

**Maximum Station:** 2487+37.299

**Design vs. Operating Speed:** true

**Predicted Speed Differential of Adjacent Elements:** true

**Specify Start/Ends Speeds:** false

**Speed at Evaluation Start (Increasing):** 62 mph

**Speed at Evaluation End (Increasing):** 62 mph

**Speed at Evaluation Start (Decreasing):** 62 mph

**Speed at Evaluation End (Decreasing):** 62 mph

### Run Time Messages

Base speed calculations from 1327+09.000 to 2487+37.299 with high speed model

Predicted 83 speeds

Adjusting 83 speeds for acceleration/deceleration

Testing 122 adjusted speeds for grade limiting.

A total of 0 speeds added or modified due to grade limiting.

Base speed calculations from 2487+37.299 to 1327+09.000 with high speed model

Predicted 83 speeds

Adjusting 83 speeds for acceleration/deceleration

Testing 124 adjusted speeds for grade limiting.

A total of 8 speeds added or modified due to grade limiting.

## **Design Consistency Results, Increasing Stations**

Figure 1 below displays the graphical results of the Design Consistency Module evaluation for travel the direction of increasing stations.

[\[Graphical Output in the DCM Engineer's Manual\]](#)

Design Consistency Summary, Increasing Direction of Travel  
 Project: Parks 305 - 325 v2, Evaluation: Evaluation 26  
 Highway: Alignment ParksHwy304-326 Asbuilt - 60 mph

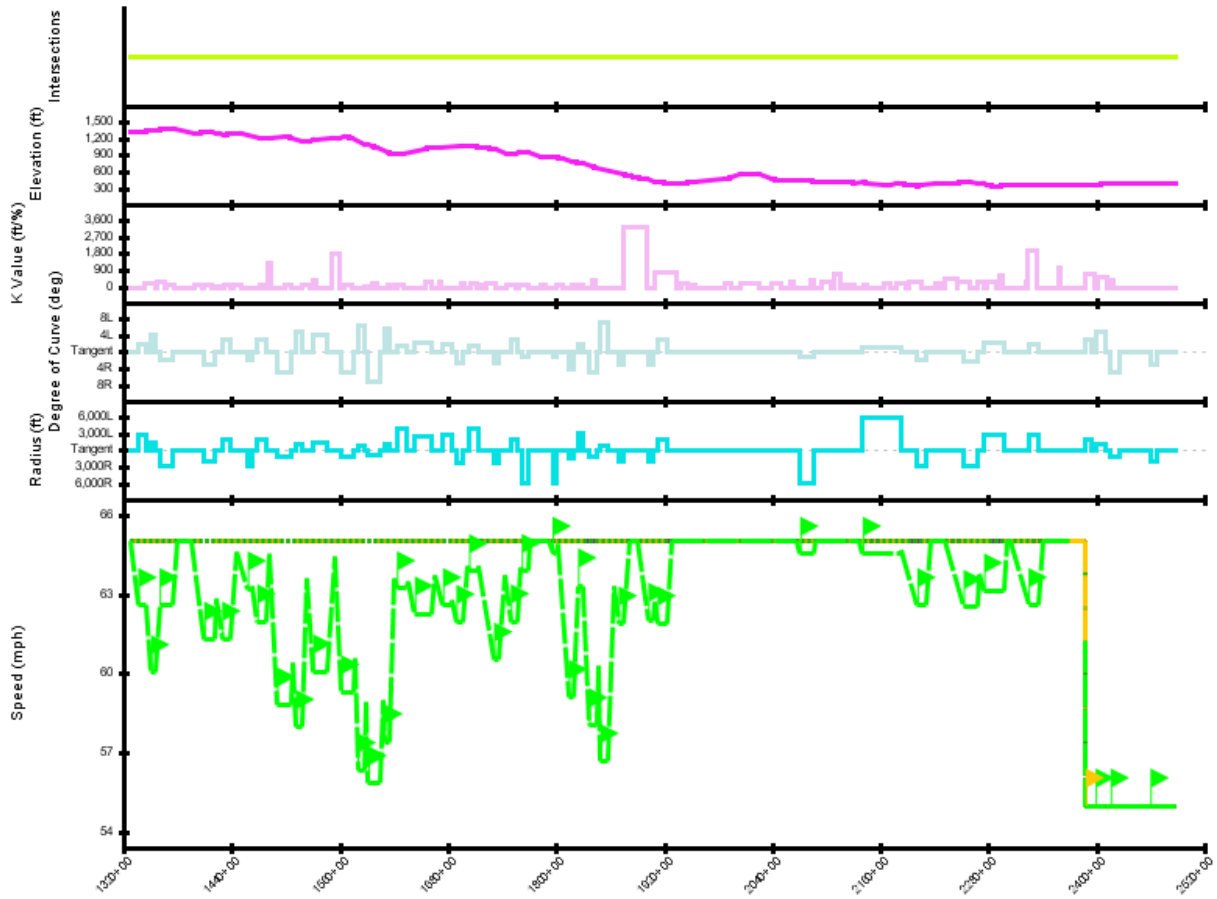

NOTE: Speed profile does NOT account for intersections.

- |   |   |
|---|---|
| <p>Legend</p> <ul style="list-style-type: none"> <li>Intersections</li> <li>Vertical Alignment (Elevation); ft</li> <li>Vertical Alignment Curvature K Value; ft/%</li> <li>Horizontal Alignment Degree of Curve; deg</li> <li>Horizontal Alignment Radius; ft</li> <li>Posted Speed; mph</li> <li>Desired Speed; mph</li> <li>Design Speed; mph</li> </ul> | <p>Station</p> <ul style="list-style-type: none"> <li>V85Speed, differential &lt; 6 MPH</li> <li>V85Speed, differential &lt;= 12 MPH</li> <li>design element differential &lt; 6 MPH</li> <li>design element differential &lt;= 12 MPH</li> </ul> |
|---|---|

**Figure 1. Graphical Results, Increasing Stations**

**V85 Speed Profile**

Table 1 displays the tabular results of the V85 speed profile evaluation for travel in the direction of increasing stations.

[V85 Speed Profile in the DCM Engineer's Manual]



**Table 1. V85 Speed Profile Coordinates, Increasing Stations**

Station	Segment Type	V85 Speed (mph)	Speed Model
1327+09.000	Non-Curve	65	High Speed
1336+44.302	Curve	63	High Speed
1345+88.891	Non-Curve	63	High Speed
1350+43.605	Curve	60	High Speed
1355+75.006	Non-Curve	60	High Speed
1359+98.149	Curve	63	High Speed
1375+23.561	Non-Curve	63	High Speed
1380+03.884	Non-Curve	65	High Speed
1395+64.189	Non-Curve	65	High Speed
1409+56.099	Curve	61	High Speed
1420+94.274	Non-Curve	61	High Speed
1423+89.182	Non-Curve	63	High Speed
1429+54.331	Curve	61	High Speed
1439+38.259	Non-Curve	61	High Speed
1445+91.701	Non-Curve	65	High Speed
1457+87.869	Curve	63	High Speed
1463+32.941	Non-Curve	63	High Speed
1463+47.099	Non-Curve	63	High Speed
1468+59.089	Curve	62	High Speed
1477+61.956	Non-Curve	62	High Speed
1482+65.513	Non-Curve	65	High Speed
1490+31.091	Curve	59	High Speed
1506+85.128	Non-Curve	59	High Speed
1508+28.092	Non-Curve	60	High Speed
1511+36.056	Curve	58	High Speed
1518+02.293	Non-Curve	58	High Speed
1523+22.102	Non-Curve	64	High Speed
1530+56.765	Curve	60	High Speed
1546+35.066	Non-Curve	60	High Speed
1554+78.582	Non-Curve	64	High Speed
1561+65.077	Curve	59	High Speed
1575+49.666	Non-Curve	59	High Speed
1576+67.061	Non-Curve	61	High Speed
1579+81.473	Curve	56	High Speed
1587+62.614	Non-Curve	56	High Speed
1589+89.799	Non-Curve	59	High Speed
1591+85.378	Curve	56	High Speed
1604+98.065	Non-Curve	56	High Speed
1607+73.737	Non-Curve	59	High Speed
1609+35.192	Curve	57	High Speed
1614+65.403	Non-Curve	57	High Speed
1620+36.351	Non-Curve	64	High Speed
1623+55.342	Curve	63	High Speed
1634+67.324	Non-Curve	63	High Speed
1635+20.505	Non-Curve	63	High Speed
1643+43.433	Curve	62	High Speed
1662+05.617	Non-Curve	62	High Speed
1664+96.300	Non-Curve	64	High Speed
1674+56.874	Curve	63	High Speed
1684+84.121	Non-Curve	63	High Speed

Station	Segment Type	V85 Speed (mph)	Speed Model
1685+18.358	Non-Curve	63	High Speed
1689+55.548	Curve	62	High Speed
1697+38.184	Non-Curve	62	High Speed
1701+61.062	Non-Curve	64	High Speed
1703+52.875	Curve	64	High Speed
1713+92.335	Non-Curve	64	High Speed
1714+33.703	Non-Curve	64	High Speed
1731+17.025	Curve	61	High Speed
1736+82.212	Non-Curve	61	High Speed
1742+99.762	Non-Curve	64	High Speed
1749+79.705	Curve	62	High Speed
1756+47.361	Non-Curve	62	High Speed
1760+54.222	Non-Curve	64	High Speed
1761+94.171	Curve	64	High Speed
1769+37.986	Non-Curve	64	High Speed
1771+64.173	Non-Curve	65	High Speed
1792+29.722	Non-Curve	65	High Speed
1796+26.415	Curve	65	High Speed
1801+11.457	Non-Curve	65	High Speed
1801+81.375	Non-Curve	65	High Speed
1814+09.517	Curve	59	High Speed
1819+97.464	Non-Curve	59	High Speed
1824+53.898	Curve	63	High Speed
1830+41.880	Non-Curve	63	High Speed
1836+58.064	Curve	58	High Speed
1844+74.496	Non-Curve	58	High Speed
1846+79.881	Non-Curve	60	High Speed
1849+15.104	Curve	57	High Speed
1858+04.945	Non-Curve	57	High Speed
1864+12.627	Non-Curve	63	High Speed
1869+49.895	Curve	62	High Speed
1875+20.742	Non-Curve	62	High Speed
1881+36.231	Non-Curve	65	High Speed
1890+40.266	Non-Curve	65	High Speed
1902+52.815	Curve	62	High Speed
1908+15.543	Non-Curve	62	High Speed
1909+48.782	Non-Curve	63	High Speed
1912+56.122	Curve	62	High Speed
1923+07.672	Non-Curve	62	High Speed
1929+23.161	Non-Curve	65	High Speed
2067+01.713	Non-Curve	65	High Speed
2070+98.406	Curve	65	High Speed
2086+40.102	Non-Curve	65	High Speed
2087+34.553	Non-Curve	65	High Speed
2136+59.950	Non-Curve	65	High Speed
2140+56.643	Curve	65	High Speed
2183+26.113	Non-Curve	65	High Speed
2183+58.100	Non-Curve	65	High Speed
2201+13.109	Curve	63	High Speed
2210+46.999	Non-Curve	63	High Speed
2215+27.322	Non-Curve	65	High Speed
2232+02.705	Non-Curve	65	High Speed

Station	Segment Type	V85 Speed (mph)	Speed Model
2252+38.958	Curve	63	High Speed
2267+68.359	Non-Curve	63	High Speed
2270+12.823	Non-Curve	64	High Speed
2275+17.825	Curve	63	High Speed
2297+86.147	Non-Curve	63	High Speed
2301+58.044	Non-Curve	65	High Speed
2303+55.582	Non-Curve	65	High Speed
2324+46.955	Curve	63	High Speed
2335+97.505	Non-Curve	63	High Speed
2340+77.950	Non-Curve	65	High Speed
2387+77.000	Non-Curve	65	High Speed
2388+01.647	Curve	55	High Speed
2393+97.841	Non-Curve	55	High Speed
2399+08.519	Curve	55	High Speed
2410+56.262	Non-Curve	55	High Speed
2415+67.769	Curve	55	High Speed
2426+42.114	Non-Curve	55	High Speed
2459+72.548	Curve	55	High Speed
2466+78.556	Non-Curve	55	High Speed
2487+37.299	Non-Curve	55	High Speed

## Design Speed Assumption

Table 2 displays the tabular results of the design speed assumption evaluation for travel in the direction of increasing stations.

[[Design Speed Assumption Check in the DCM Engineer's Manual](#)]

**Table 2. Design Speed Assumption, Increasing Stations**

From Station	To Station	Min (mph)	Max (mph)	Condition
1327+09.000	2340+77.950	-9	0	4
2340+77.950	2369+97.804	0	6	1
2369+97.804	2387+86.332	6	10	2
2387+86.332	2388+01.647	0	6	1
2388+01.647	2487+37.299	0	0	4

**Design Speed Assumption Check Conditions Key**

Condition 1:  $0 \text{ mph} \leq (V_{85} - V_{\text{design}}) \leq 6 \text{ mph}$

Condition 2:  $6 \text{ mph} < (V_{85} - V_{\text{design}}) \leq 12 \text{ mph}$

Condition 3:  $12 \text{ mph} < (V_{85} - V_{\text{design}})$

Condition 4:  $(V_{85} - V_{\text{design}}) < 0 \text{ mph}$

where:

V85: estimated 85th percentile operating speed

V<sub>design</sub>: design speed

**Speed Differential of Adjacent Design Elements**

Table 3 displays the tabular results of the speed differential of adjacent design elements evaluation for travel in the direction of increasing stations.

[[Speed Differential of Adjacent Design Elements Check in the DCM Engineer's Manual](#)]

**Table 3. Speed Differential of Adjacent Design Elements, Increasing Stations**

Station of Max Speed on Preceding Element	Max Speed on Preceding Element (mph)	Start of Curve	Speed on Curve (mph)	Speed Differential (mph)	Condition
1327+09.000	65	1336+44.302	63	2	1
1336+44.302	63	1350+43.605	60	3	1
1350+43.605	60	1359+98.149	63	-3	1
1380+03.884	65	1409+56.099	61	4	1
1423+89.182	63	1429+54.331	61	2	1
1445+91.701	65	1457+87.869	63	1	1
1463+47.099	63	1468+59.089	62	1	1
1482+65.513	65	1490+31.091	59	6	1
1508+28.092	60	1511+36.056	58	2	1
1523+22.102	64	1530+56.765	60	4	1
1554+78.582	64	1561+65.077	59	5	1
1576+67.061	61	1579+81.473	56	4	1
1589+89.799	59	1591+85.378	56	3	1
1607+73.737	59	1609+35.192	57	2	1
1620+36.351	64	1623+55.342	63	0	1
1635+20.505	63	1643+43.433	62	1	1
1664+96.300	64	1674+56.874	63	1	1
1685+18.358	63	1689+55.548	62	1	1
1701+61.062	64	1703+52.875	64	0	1
1714+33.703	64	1731+17.025	61	4	1
1742+99.762	64	1749+79.705	62	2	1
1760+54.222	64	1761+94.171	64	0	1
1771+64.173	65	1796+26.415	65	0	1
1801+81.375	65	1814+09.517	59	6	1
1814+09.517	59	1824+53.898	63	-4	1
1824+53.898	63	1836+58.064	58	5	1
1846+79.881	60	1849+15.104	57	4	1
1864+12.627	63	1869+49.895	62	1	1
1881+36.231	65	1902+52.815	62	3	1
1909+48.782	63	1912+56.122	62	1	1
1929+23.161	65	2070+98.406	65	0	1
2087+34.553	65	2140+56.643	65	0	1
2183+58.100	65	2201+13.109	63	2	1
2215+27.322	65	2252+38.958	63	2	1
2270+12.823	64	2275+17.825	63	1	1
2301+58.044	65	2324+46.955	63	2	1
2340+77.950	65	2388+01.647	55	10	2
2388+01.647	55	2399+08.519	55	0	1
2399+08.519	55	2415+67.769	55	0	1
2415+67.769	55	2459+72.548	55	0	1

**Speed Differential of Adjacent Design Elements Check Conditions Key**Condition 1:  $0 \text{ mph} < (V_{85_{\text{Tangent}}} - V_{85_{\text{Curve}}}) \leq 6 \text{ mph}$ Condition 2:  $6 \text{ mph} < (V_{85_{\text{Tangent}}} - V_{85_{\text{Curve}}}) \leq 12 \text{ mph}$ Condition 3:  $12 \text{ mph} < (V_{85_{\text{Tangent}}} - V_{85_{\text{Curve}}})$

where:

$V85_{\text{Tangent}}$ : estimated 85th percentile operating speed on tangent

$V85_{\text{Curve}}$ : estimated 85th percentile operating speed at the beginning of the curve

## **Design Consistency Results, Decreasing Stations**

Figure 2 below displays the graphical results of the Design Consistency Module evaluation for travel the direction of decreasing stations.

[\[Graphical Output in the DCM Engineer's Manual\]](#)

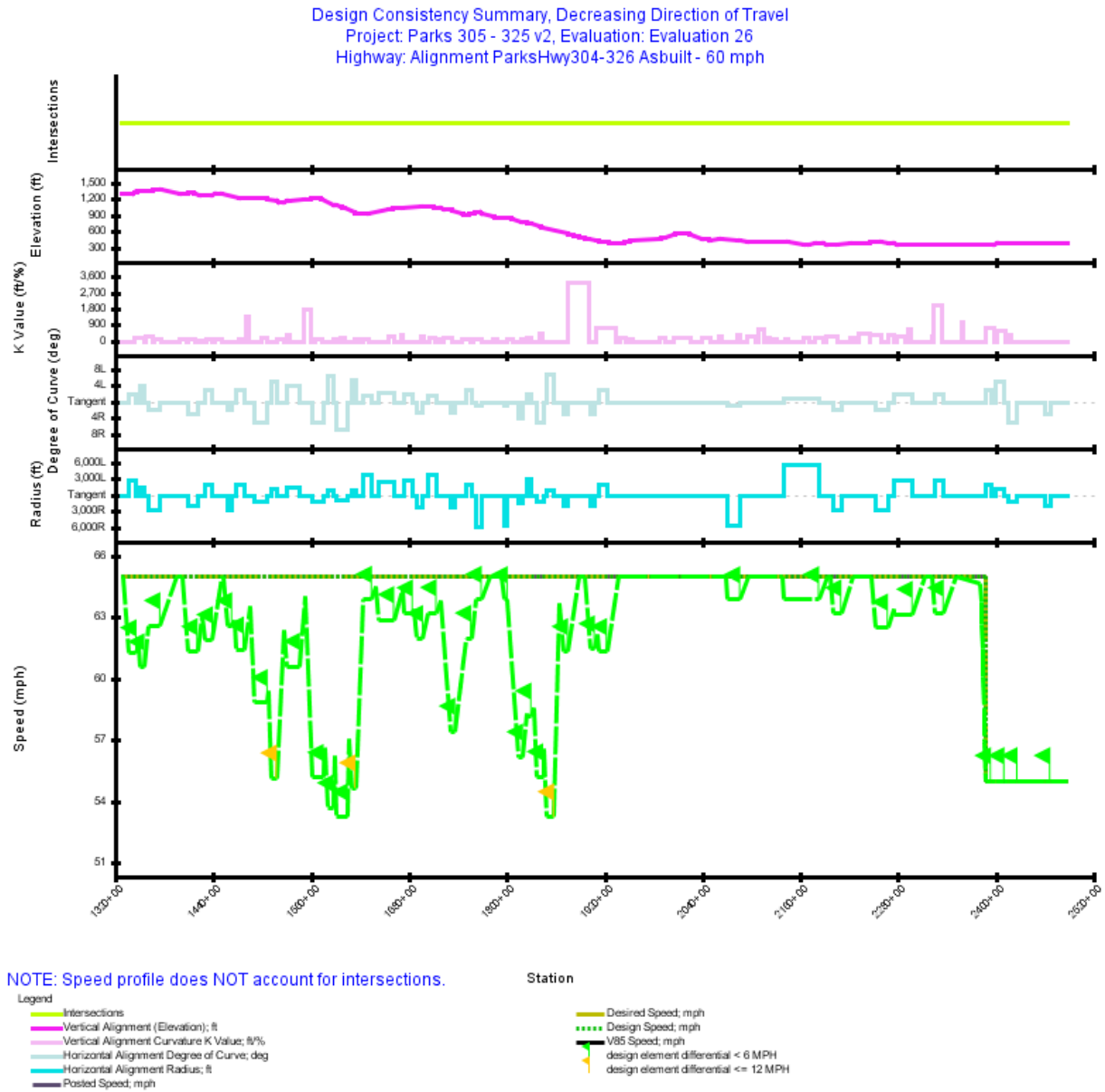

Figure 2. Graphical Results, Decreasing Stations

V85 Speed Profile

Table 4 displays the tabular results of the V85 speed profile evaluation for travel in the direction of decreasing stations.

[V85 Speed Profile in the DCM Engineer's Manual]

**Table 4. V85 Speed Profile Coordinates, Decreasing Stations**

Station	Segment Type	V85 Speed (mph)	Speed Model
2487+37.299	Non-Curve	55	High Speed
2466+78.556	Curve	55	High Speed
2459+72.548	Non-Curve	55	High Speed
2426+42.114	Curve	55	High Speed
2415+67.769	Non-Curve	55	High Speed
2410+56.262	Curve	55	High Speed
2399+08.519	Non-Curve	55	High Speed
2393+97.841	Curve	55	High Speed
2388+01.647	Non-Curve	55	High Speed
2387+34.632	Non-Curve	55	High Speed
2386+52.574	Non-Curve	57	High Speed
2385+67.881	Non-Curve	59	High Speed
2384+80.840	Non-Curve	60	High Speed
2383+91.703	Non-Curve	61	High Speed
2383+00.696	Non-Curve	63	High Speed
2382+08.023	Non-Curve	64	High Speed
2381+13.862	Non-Curve	65	High Speed
2351+55.082	Non-Curve	65	High Speed
2335+97.505	Curve	63	High Speed
2324+46.955	Non-Curve	63	High Speed
2320+89.138	Non-Curve	65	High Speed
2313+19.477	Non-Curve	65	High Speed
2297+86.147	Curve	63	High Speed
2275+17.825	Non-Curve	63	High Speed
2274+69.700	Non-Curve	63	High Speed
2267+68.359	Curve	63	High Speed
2252+38.958	Non-Curve	63	High Speed
2247+45.081	Non-Curve	65	High Speed
2225+49.297	Non-Curve	65	High Speed
2210+46.999	Curve	63	High Speed
2201+13.109	Non-Curve	63	High Speed
2197+55.419	Non-Curve	65	High Speed
2192+89.030	Non-Curve	65	High Speed
2183+26.113	Curve	64	High Speed
2140+56.643	Non-Curve	64	High Speed
2138+27.377	Non-Curve	65	High Speed
2096+03.019	Non-Curve	65	High Speed
2086+40.102	Curve	64	High Speed
2070+98.406	Non-Curve	64	High Speed
2068+69.140	Non-Curve	65	High Speed
1936+99.582	Non-Curve	65	High Speed
1923+07.672	Curve	61	High Speed
1912+56.122	Non-Curve	61	High Speed
1910+94.744	Non-Curve	62	High Speed
1908+15.543	Curve	61	High Speed
1902+52.815	Non-Curve	61	High Speed
1895+52.389	Non-Curve	65	High Speed
1889+12.652	Non-Curve	65	High Speed
1875+20.742	Curve	61	High Speed
1869+49.895	Non-Curve	61	High Speed



Station	Segment Type	V85 Speed (mph)	Speed Model
1864+84.173	Non-Curve	64	High Speed
1858+04.945	Curve	53	High Speed
1849+15.104	Non-Curve	53	High Speed
1846+38.730	Non-Curve	57	High Speed
1844+74.496	Curve	55	High Speed
1836+58.064	Non-Curve	55	High Speed
1833+64.212	Non-Curve	59	High Speed
1830+41.880	Curve	58	High Speed
1824+53.898	Non-Curve	58	High Speed
1824+23.605	Non-Curve	58	High Speed
1819+97.464	Curve	56	High Speed
1814+09.517	Non-Curve	56	High Speed
1801+11.457	Curve	64	High Speed
1796+26.415	Non-Curve	64	High Speed
1793+97.149	Non-Curve	65	High Speed
1778+87.971	Non-Curve	65	High Speed
1769+37.986	Curve	64	High Speed
1761+94.171	Non-Curve	64	High Speed
1756+47.361	Curve	62	High Speed
1749+79.705	Non-Curve	62	High Speed
1736+82.212	Curve	57	High Speed
1731+17.025	Non-Curve	57	High Speed
1719+02.554	Non-Curve	64	High Speed
1713+92.335	Curve	63	High Speed
1703+52.875	Non-Curve	63	High Speed
1697+38.184	Curve	62	High Speed
1689+55.548	Non-Curve	62	High Speed
1686+65.980	Non-Curve	63	High Speed
1684+84.121	Curve	63	High Speed
1674+56.874	Non-Curve	63	High Speed
1672+24.591	Non-Curve	64	High Speed
1662+05.617	Curve	63	High Speed
1643+43.433	Non-Curve	63	High Speed
1640+16.724	Non-Curve	65	High Speed
1634+67.324	Curve	64	High Speed
1623+55.342	Non-Curve	64	High Speed
1614+65.403	Curve	55	High Speed
1609+35.192	Non-Curve	55	High Speed
1607+31.156	Non-Curve	57	High Speed
1604+98.065	Curve	53	High Speed
1591+85.378	Non-Curve	53	High Speed
1589+38.332	Non-Curve	56	High Speed
1587+62.614	Curve	54	High Speed
1579+81.473	Non-Curve	54	High Speed
1577+30.295	Non-Curve	57	High Speed
1575+49.666	Curve	55	High Speed
1561+65.077	Non-Curve	55	High Speed
1553+59.194	Non-Curve	64	High Speed
1546+35.066	Curve	61	High Speed
1530+56.765	Non-Curve	61	High Speed
1527+14.868	Non-Curve	62	High Speed
1518+02.293	Curve	55	High Speed

Station	Segment Type	V85 Speed (mph)	Speed Model
1511+36.056	Non-Curve	55	High Speed
1507+61.859	Non-Curve	59	High Speed
1506+85.128	Curve	59	High Speed
1490+31.091	Non-Curve	59	High Speed
1485+92.399	Non-Curve	64	High Speed
1477+61.956	Curve	61	High Speed
1468+59.089	Non-Curve	61	High Speed
1465+71.361	Non-Curve	63	High Speed
1463+32.941	Curve	63	High Speed
1457+87.869	Non-Curve	63	High Speed
1453+07.546	Non-Curve	65	High Speed
1451+17.758	Non-Curve	65	High Speed
1439+38.259	Curve	62	High Speed
1429+54.331	Non-Curve	62	High Speed
1427+32.258	Non-Curve	63	High Speed
1420+94.274	Curve	61	High Speed
1409+56.099	Non-Curve	61	High Speed
1402+29.769	Non-Curve	65	High Speed
1395+40.919	Non-Curve	65	High Speed
1375+23.561	Curve	63	High Speed
1359+98.149	Non-Curve	63	High Speed
1355+75.006	Curve	61	High Speed
1350+43.605	Non-Curve	61	High Speed
1348+51.806	Non-Curve	62	High Speed
1345+88.891	Curve	61	High Speed
1336+44.302	Non-Curve	61	High Speed
1329+05.658	Non-Curve	65	High Speed
1327+09.000	Non-Curve	65	High Speed

## Design Speed Assumption

Table 5 displays the tabular results of the design speed assumption evaluation for travel in the direction of decreasing stations.

[[Design Speed Assumption Check in the DCM Engineer's Manual](#)]

**Table 5. Design Speed Assumption, Decreasing Stations**

From Station	To Station	Min (mph)	Max (mph)	Condition
2487+37.299	1327+09.000	-12	0	4

**Design Speed Assumption Check Conditions Key**

Condition 1:  $0 \text{ mph} \leq (V_{85} - V_{\text{design}}) \leq 6 \text{ mph}$

Condition 2:  $6 \text{ mph} < (V_{85} - V_{\text{design}}) \leq 12 \text{ mph}$

Condition 3:  $12 \text{ mph} < (V_{85} - V_{\text{design}})$

Condition 4:  $(V_{85} - V_{\text{design}}) < 0 \text{ mph}$

where:

$V_{85}$ : estimated 85th percentile operating speed

$V_{\text{design}}$ : design speed

**Speed Differential of Adjacent Design Elements**

Table 6 displays the tabular results of the speed differential of adjacent design elements evaluation for travel in the direction of decreasing stations.

[\[Speed Differential of Adjacent Design Elements Check in the DCM Engineer's Manual\]](#)

**Table 6. Speed Differential of Adjacent Design Elements, Decreasing Stations**

Station of Max Speed on Preceding Element	Max Speed on Preceding Element (mph)	Start of Curve	Speed on Curve (mph)	Speed Differential (mph)	Condition
2487+37.299	55	2466+78.556	55	0	1
2466+78.556	55	2426+42.114	55	0	1
2426+42.114	55	2410+56.262	55	0	1
2410+56.262	55	2393+97.841	55	0	1
2351+55.082	65	2335+97.505	63	2	1
2320+89.138	65	2297+86.147	63	2	1
2274+69.700	63	2267+68.359	63	1	1
2247+45.081	65	2210+46.999	63	2	1
2197+55.419	65	2183+26.113	64	1	1
2138+27.377	65	2086+40.102	64	1	1
2068+69.140	65	1923+07.672	61	4	1
1910+94.744	62	1908+15.543	61	1	1
1895+52.389	65	1875+20.742	61	4	1
1864+84.173	64	1858+04.945	53	10	2
1846+38.730	57	1844+74.496	55	1	1
1833+64.212	59	1830+41.880	58	0	1
1824+23.605	58	1819+97.464	56	2	1
1819+97.464	56	1801+11.457	64	-8	1
1793+97.149	65	1769+37.986	64	1	1
1769+37.986	64	1756+47.361	62	2	1
1756+47.361	62	1736+82.212	57	5	1
1719+02.554	64	1713+92.335	63	1	1
1713+92.335	63	1697+38.184	62	1	1
1686+65.980	63	1684+84.121	63	0	1
1672+24.591	64	1662+05.617	63	2	1
1640+16.724	65	1634+67.324	64	1	1
1634+67.324	64	1614+65.403	55	9	2
1607+31.156	57	1604+98.065	53	4	1
1589+38.332	56	1587+62.614	54	3	1
1577+30.295	57	1575+49.666	55	1	1
1553+59.194	64	1546+35.066	61	3	1
1527+14.868	62	1518+02.293	55	7	2
1507+61.859	59	1506+85.128	59	1	1
1485+92.399	64	1477+61.956	61	2	1
1465+71.361	63	1463+32.941	63	0	1
1453+07.546	65	1439+38.259	62	3	1
1427+32.258	63	1420+94.274	61	2	1
1402+29.769	65	1375+23.561	63	2	1
1375+23.561	63	1355+75.006	61	2	1
1348+51.806	62	1345+88.891	61	0	1

**Speed Differential of Adjacent Design Elements Check Conditions Key**Condition 1:  $0 \text{ mph} < (V_{85_{\text{Tangent}}} - V_{85_{\text{Curve}}}) \leq 6 \text{ mph}$ Condition 2:  $6 \text{ mph} < (V_{85_{\text{Tangent}}} - V_{85_{\text{Curve}}}) \leq 12 \text{ mph}$ Condition 3:  $12 \text{ mph} < (V_{85_{\text{Tangent}}} - V_{85_{\text{Curve}}})$

where:

$V_{85_{\text{Tangent}}}$ : estimated 85th percentile operating speed on tangent

$V_{85_{\text{Curve}}}$ : estimated 85th percentile operating speed at the beginning of the curve

*Interactive Highway Safety Design Model*

**Design Consistency Evaluation Report**

**P1 Alignment Alternative**

April 3, 2018



## **Disclaimer**

The Interactive Highway Design Model (IHSDM) software is disseminated under the sponsorship of the Department of Transportation in the interest of information exchange. The United States Government assumes no liability for its content or use thereof. This document does not constitute a standard, specification, or regulation.

The United States Government does not endorse products or manufacturers. Trade and manufacturers' names may appear in this software and documentation only because they are considered essential to the objective of the software.

## **Limited Warranty and Limitations of Remedies**

This software product is provided "as-is," without warranty of any kind-either expressed or implied (but not limited to the implied warranties of merchantability and fitness for a particular purpose). The FHWA do not warrant that the functions contained in the software will meet the end-user's requirements or that the operation of the software will be uninterrupted and error-free.

Under no circumstances will the FHWA be liable to the end-user for any damages or claimed lost profits, lost savings, or other incidental or consequential damages rising out of the use or inability to use the software (even if these organizations have been advised of the possibility of such damages), or for any claim by any other party.

## **Notice**

The use of the IHSDM software is being done strictly on a voluntary basis. In exchange for provision of IHSDM, the user agrees that the Federal Highway Administration (FHWA), U.S. Department of Transportation and any other agency of the Federal Government shall not be responsible for any errors, damage or other liability that may result from any and all use of the software, including installation and testing of the software. The user further agrees to hold the FHWA and the Federal Government harmless from any resulting liability. The user agrees that this hold harmless provision shall flow to any person to whom or any entity to which the user provides the IHSDM software. It is the user's full responsibility to inform any person to whom or any entity to which it provides the IHSDM software of this hold harmless provision.



**Table of Contents**

**Report Overview** ..... **1**  
**Design Consistency Results, Increasing Stations** ..... **2**  
**Design Consistency Results, Decreasing Stations** ..... **8**

**List of Tables**

Table V85 Speed Profile Coordinates, Increasing Stations ..... 4  
Table Design Speed Assumption, Increasing Stations ..... 6  
Table Speed Differential of Adjacent Design Elements, Increasing Stations ..... 7  
Table V85 Speed Profile Coordinates, Decreasing Stations ..... 10  
Table Design Speed Assumption, Decreasing Stations ..... 12  
Table Speed Differential of Adjacent Design Elements, Decreasing Stations ..... 13

**List of Figures**

Figure Graphical Results, Increasing Stations ..... 3  
Figure Graphical Results, Decreasing Stations ..... 9

## Report Overview

**Report Generated:** Apr 3, 2018 4:01 PM

**Report Template:** System: Single Page, by Travel Direction [System] (dcm5, Oct 9, 2017 1:45 PM)

**Evaluation Date:** Tue Apr 03 14:00:58 AKDT 2018

**IHSDM Version:** v13.0.0 (Sep 13, 2017)

**Design Consistency Module:** v4.0.0 (Sep 23, 2016)

**User Name:** RaeAnne Hebnes

**Organization Name:** Michael Baker International

**Phone:**

**E-Mail:**

**Project Title:** P1

**Project Comment:** Created using wizard

**Project Unit System:** U.S. Customary

**Highway Title:** Alignment P1\_6apr2018

**Highway Comment:** Copied from Alignment P1\_29dec2017 (v3); revised passing lanes

**Highway Version:** 1

**Evaluation Title:** Evaluation 3

**Evaluation Comment:** Created Tue Apr 03 14:00:45 AKDT 2018

**Minimum Station:** 1327+09.000

**Maximum Station:** 2468+96.256

**Design vs. Operating Speed:** true

**Predicted Speed Differential of Adjacent Elements:** true

**Specify Start/Ends Speeds:** false

**Speed at Evaluation Start (Increasing):** 62 mph

**Speed at Evaluation End (Increasing):** 62 mph

**Speed at Evaluation Start (Decreasing):** 62 mph

**Speed at Evaluation End (Decreasing):** 62 mph

### Run Time Messages

Base speed calculations from 1327+09.000 to 2468+96.256 with high speed model

Predicted 64 speeds

Adjusting 64 speeds for acceleration/deceleration

Testing 103 adjusted speeds for grade limiting.

A total of 0 speeds added or modified due to grade limiting.

Base speed calculations from 2468+96.256 to 1327+09.000 with high speed model

Predicted 64 speeds

Adjusting 64 speeds for acceleration/deceleration

Testing 102 adjusted speeds for grade limiting.

A total of 0 speeds added or modified due to grade limiting.

## **Design Consistency Results, Increasing Stations**

Figure 1 below displays the graphical results of the Design Consistency Module evaluation for travel the direction of increasing stations.

[\[Graphical Output in the DCM Engineer's Manual\]](#)

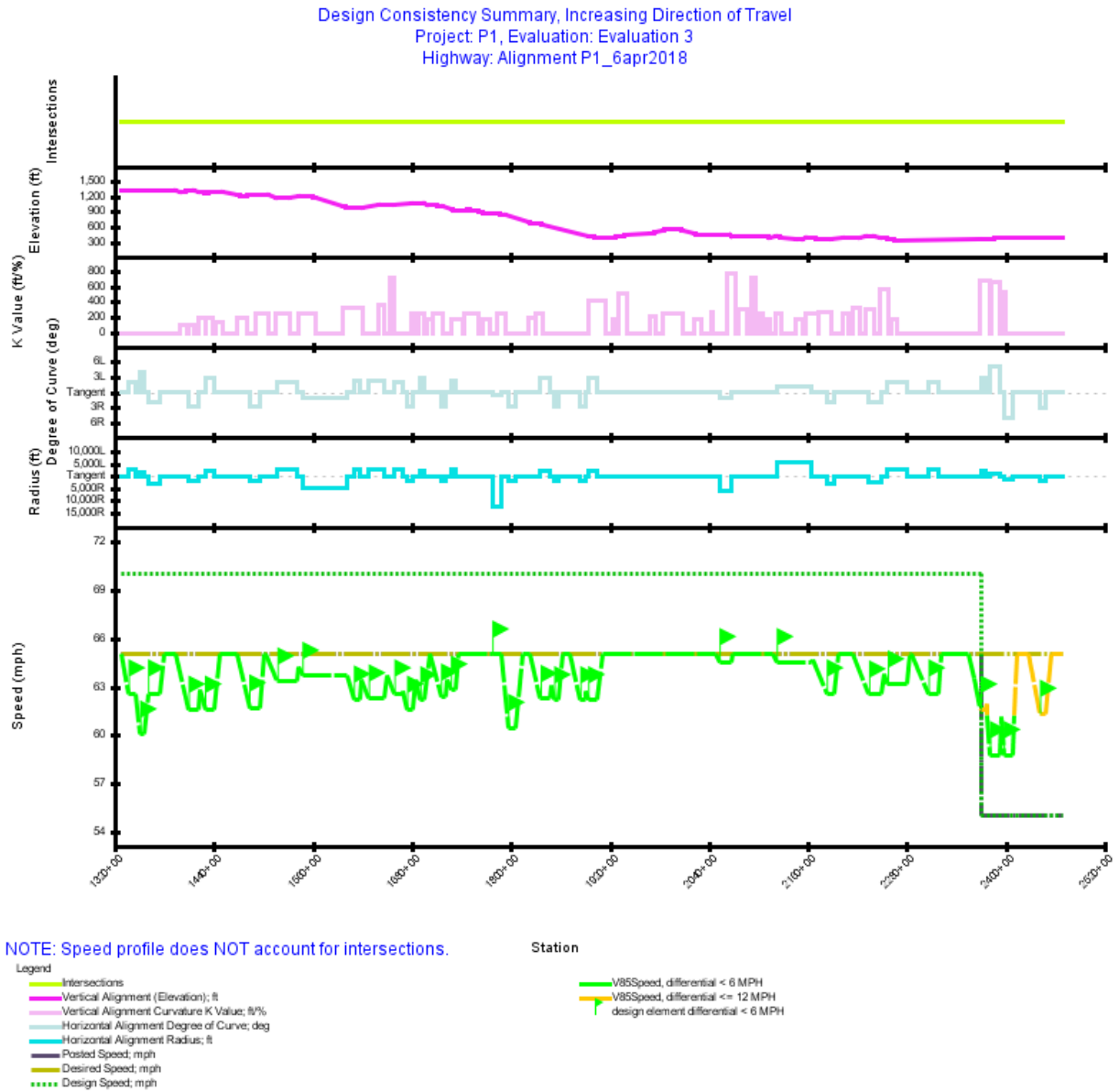

Figure 1. Graphical Results, Increasing Stations

V85 Speed Profile

Table 1 displays the tabular results of the V85 speed profile evaluation for travel in the direction of increasing stations.

[V85 Speed Profile in the DCM Engineer's Manual]

**Table 1. V85 Speed Profile Coordinates, Increasing Stations**

Station	Segment Type	V85 Speed (mph)	Speed Model
1327+09.000	Non-Curve	65	High Speed
1336+44.302	Curve	63	High Speed
1345+88.891	Non-Curve	63	High Speed
1350+43.605	Curve	60	High Speed
1355+75.006	Non-Curve	60	High Speed
1359+98.149	Curve	63	High Speed
1375+23.561	Non-Curve	63	High Speed
1380+03.884	Non-Curve	65	High Speed
1394+18.059	Non-Curve	65	High Speed
1409+13.059	Curve	62	High Speed
1421+34.750	Non-Curve	62	High Speed
1423+77.727	Non-Curve	63	High Speed
1429+14.849	Curve	62	High Speed
1439+70.975	Non-Curve	62	High Speed
1446+47.265	Non-Curve	65	High Speed
1467+48.763	Non-Curve	65	High Speed
1482+80.502	Curve	62	High Speed
1495+04.091	Non-Curve	62	High Speed
1501+64.099	Non-Curve	65	High Speed
1502+94.187	Non-Curve	65	High Speed
1516+97.763	Curve	63	High Speed
1540+55.785	Non-Curve	63	High Speed
1542+40.040	Non-Curve	64	High Speed
1547+28.434	Curve	64	High Speed
1601+34.699	Non-Curve	64	High Speed
1609+61.022	Curve	62	High Speed
1616+84.156	Non-Curve	62	High Speed
1619+32.813	Non-Curve	63	High Speed
1627+49.440	Curve	62	High Speed
1646+14.198	Non-Curve	62	High Speed
1649+04.024	Non-Curve	64	High Speed
1658+64.069	Curve	63	High Speed
1668+91.391	Non-Curve	63	High Speed
1669+16.247	Non-Curve	63	High Speed
1674+04.477	Curve	62	High Speed
1681+04.530	Non-Curve	62	High Speed
1684+62.403	Non-Curve	63	High Speed
1690+03.213	Curve	62	High Speed
1695+61.079	Non-Curve	62	High Speed
1701+24.142	Non-Curve	65	High Speed
1702+38.875	Non-Curve	65	High Speed
1715+28.063	Curve	62	High Speed
1720+93.250	Non-Curve	62	High Speed
1723+10.781	Non-Curve	63	High Speed
1727+11.379	Curve	63	High Speed
1732+47.637	Non-Curve	63	High Speed
1736+81.123	Non-Curve	65	High Speed
1777+26.252	Curve	65	High Speed
1787+88.934	Non-Curve	65	High Speed
1796+64.739	Curve	60	High Speed

Station	Segment Type	V85 Speed (mph)	Speed Model
1805+16.197	Non-Curve	60	High Speed
1814+06.357	Non-Curve	65	High Speed
1823+33.756	Non-Curve	65	High Speed
1836+00.912	Curve	62	High Speed
1846+67.512	Non-Curve	62	High Speed
1848+34.087	Non-Curve	63	High Speed
1852+40.031	Curve	62	High Speed
1857+23.946	Non-Curve	62	High Speed
1862+87.009	Non-Curve	65	High Speed
1871+62.904	Non-Curve	65	High Speed
1884+07.604	Curve	62	High Speed
1889+90.226	Non-Curve	62	High Speed
1891+04.860	Non-Curve	63	High Speed
1893+58.268	Curve	62	High Speed
1904+85.312	Non-Curve	62	High Speed
1910+48.375	Non-Curve	65	High Speed
2048+65.673	Non-Curve	65	High Speed
2052+62.284	Curve	65	High Speed
2067+99.438	Non-Curve	65	High Speed
2068+93.869	Non-Curve	65	High Speed
2118+19.140	Non-Curve	65	High Speed
2122+15.751	Curve	65	High Speed
2164+85.534	Non-Curve	65	High Speed
2165+17.496	Non-Curve	65	High Speed
2182+72.331	Curve	63	High Speed
2192+06.289	Non-Curve	63	High Speed
2196+86.576	Non-Curve	65	High Speed
2213+60.654	Non-Curve	65	High Speed
2233+97.851	Curve	63	High Speed
2249+27.960	Non-Curve	63	High Speed
2251+72.161	Non-Curve	64	High Speed
2256+76.507	Curve	63	High Speed
2279+45.879	Non-Curve	63	High Speed
2283+17.528	Non-Curve	65	High Speed
2285+88.740	Non-Curve	65	High Speed
2306+05.945	Curve	63	High Speed
2317+56.861	Non-Curve	63	High Speed
2322+37.148	Non-Curve	65	High Speed
2354+43.765	Non-Curve	65	High Speed
2369+38.765	Curve	62	High Speed
2375+78.706	Non-Curve	62	High Speed
2376+54.305	Non-Curve	62	High Speed
2380+67.835	Curve	59	High Speed
2392+14.656	Non-Curve	59	High Speed
2394+27.900	Non-Curve	61	High Speed
2397+27.128	Curve	59	High Speed
2408+00.619	Non-Curve	59	High Speed
2413+88.681	Non-Curve	65	High Speed
2427+35.434	Non-Curve	65	High Speed
2441+31.129	Curve	61	High Speed
2448+37.898	Non-Curve	61	High Speed
2455+62.268	Non-Curve	65	High Speed

Station	Segment Type	V85 Speed (mph)	Speed Model
2468+96.256	Non-Curve	65	High Speed

## Design Speed Assumption

Table 2 displays the tabular results of the design speed assumption evaluation for travel in the direction of increasing stations.

[[Design Speed Assumption Check in the DCM Engineer's Manual](#)]

**Table 2. Design Speed Assumption, Increasing Stations**

From Station	To Station	Min (mph)	Max (mph)	Condition
1327+09.000	2360+89.416	-10	0	4
2360+89.416	2368+91.794	0	6	1
2368+91.794	2377+51.919	6	7	2
2377+51.919	2410+31.407	4	6	1
2410+31.407	2468+96.256	6	10	2

### Design Speed Assumption Check Conditions Key

Condition 1:  $0 \text{ mph} \leq (V_{85} - V_{\text{design}}) \leq 6 \text{ mph}$

Condition 2:  $6 \text{ mph} < (V_{85} - V_{\text{design}}) \leq 12 \text{ mph}$

Condition 3:  $12 \text{ mph} < (V_{85} - V_{\text{design}})$

Condition 4:  $(V_{85} - V_{\text{design}}) < 0 \text{ mph}$

where:

$V_{85}$ : estimated 85th percentile operating speed

$V_{\text{design}}$ : design speed

### Speed Differential of Adjacent Design Elements

Table 3 displays the tabular results of the speed differential of adjacent design elements evaluation for travel in the direction of increasing stations.

[Speed Differential of Adjacent Design Elements Check in the DCM Engineer's Manual]

**Table 3. Speed Differential of Adjacent Design Elements, Increasing Stations**

Station of Max Speed on Preceding Element	Max Speed on Preceding Element (mph)	Start of Curve	Speed on Curve (mph)	Speed Differential (mph)	Condition
1327+09.000	65	1336+44.302	63	2	1
1336+44.302	63	1350+43.605	60	3	1
1350+43.605	60	1359+98.149	63	-3	1
1380+03.884	65	1409+13.059	62	3	1
1423+77.727	63	1429+14.849	62	1	1
1446+47.265	65	1482+80.502	62	3	1
1501+64.099	65	1516+97.763	63	2	1
1542+40.040	64	1547+28.434	64	1	1
1547+28.434	64	1609+61.022	62	1	1
1619+32.813	63	1627+49.440	62	1	1
1649+04.024	64	1658+64.069	63	1	1
1669+16.247	63	1674+04.477	62	1	1
1684+62.403	63	1690+03.213	62	1	1
1701+24.142	65	1715+28.063	62	3	1
1723+10.781	63	1727+11.379	63	1	1
1736+81.123	65	1777+26.252	65	0	1
1777+26.252	65	1796+64.739	60	5	1
1814+06.357	65	1836+00.912	62	3	1
1848+34.087	63	1852+40.031	62	1	1
1862+87.009	65	1884+07.604	62	3	1
1891+04.860	63	1893+58.268	62	1	1
1910+48.375	65	2052+62.284	65	0	1
2068+93.869	65	2122+15.751	65	0	1
2165+17.496	65	2182+72.331	63	2	1
2196+86.576	65	2233+97.851	63	2	1
2251+72.161	64	2256+76.507	63	1	1
2283+17.528	65	2306+05.945	63	2	1
2322+37.148	65	2369+38.765	62	3	1
2376+54.305	62	2380+67.835	59	3	1
2394+27.900	61	2397+27.128	59	2	1
2413+88.681	65	2441+31.129	61	4	1

**Speed Differential of Adjacent Design Elements Check Conditions Key**

Condition 1:  $0 \text{ mph} < (V_{85_{\text{Tangent}}} - V_{85_{\text{Curve}}}) \leq 6 \text{ mph}$

Condition 2:  $6 \text{ mph} < (V_{85_{\text{Tangent}}} - V_{85_{\text{Curve}}}) \leq 12 \text{ mph}$



Condition 3:  $12 \text{ mph} < (V85_{\text{Tangent}} - V85_{\text{Curve}})$

where:

$V85_{\text{Tangent}}$ : estimated 85th percentile operating speed on tangent

$V85_{\text{Curve}}$ : estimated 85th percentile operating speed at the beginning of the curve

## **Design Consistency Results, Decreasing Stations**

Figure 2 below displays the graphical results of the Design Consistency Module evaluation for travel the direction of decreasing stations.

[\[Graphical Output in the DCM Engineer's Manual\]](#)

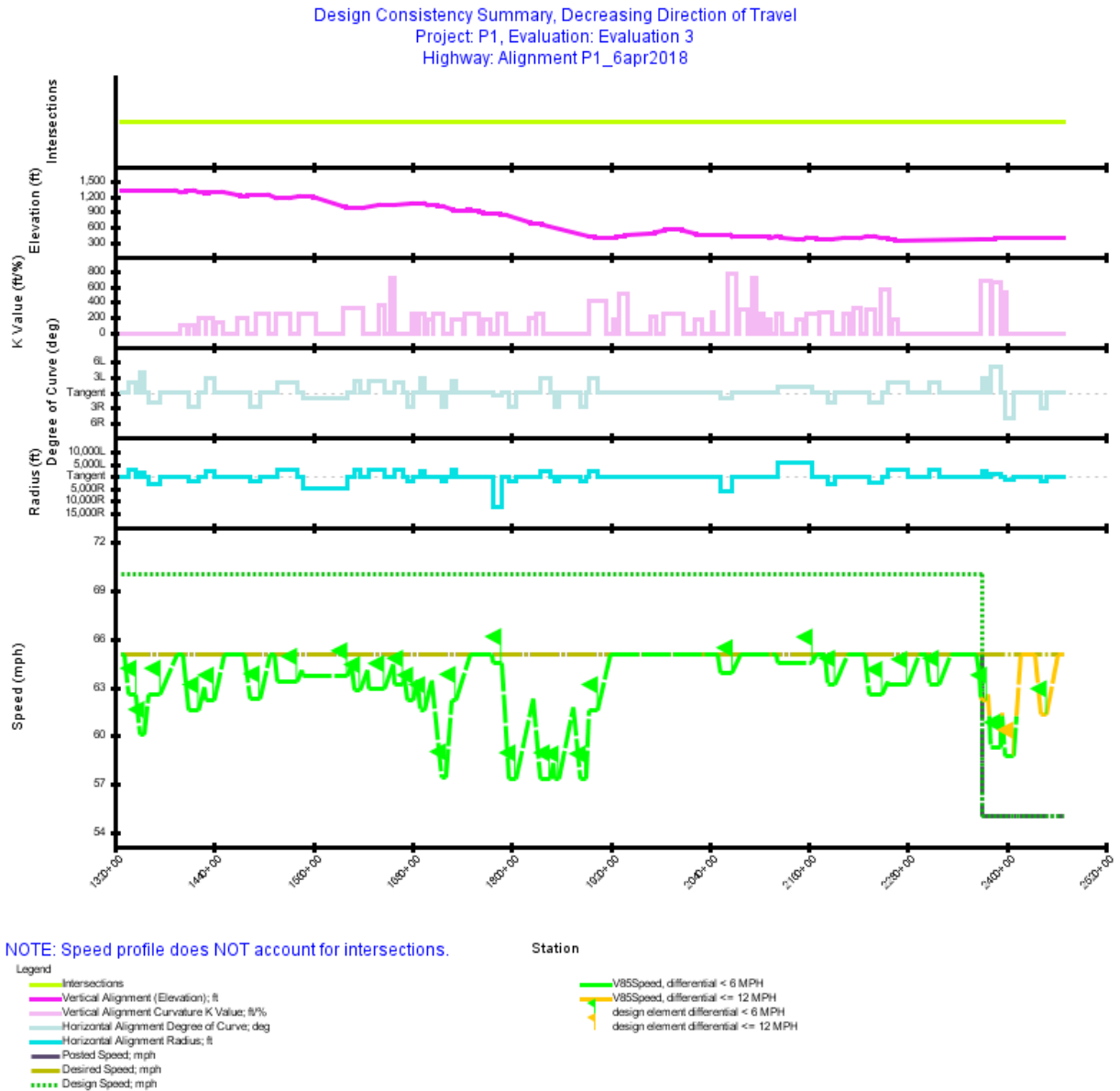

Figure 2. Graphical Results, Decreasing Stations

V85 Speed Profile

Table 4 displays the tabular results of the V85 speed profile evaluation for travel in the direction of decreasing stations.

[V85 Speed Profile in the DCM Engineer's Manual]

**Table 4. V85 Speed Profile Coordinates, Decreasing Stations**

Station	Segment Type	V85 Speed (mph)	Speed Model
2468+96.256	Non-Curve	65	High Speed
2462+33.593	Non-Curve	65	High Speed
2448+37.898	Curve	61	High Speed
2441+31.129	Non-Curve	61	High Speed
2434+06.759	Non-Curve	65	High Speed
2416+25.797	Non-Curve	65	High Speed
2408+00.619	Curve	59	High Speed
2397+27.128	Non-Curve	59	High Speed
2394+88.681	Non-Curve	61	High Speed
2392+14.656	Curve	59	High Speed
2380+67.835	Non-Curve	59	High Speed
2377+58.254	Non-Curve	63	High Speed
2375+78.706	Curve	62	High Speed
2369+38.765	Non-Curve	62	High Speed
2363+75.702	Non-Curve	65	High Speed
2332+58.999	Non-Curve	65	High Speed
2317+56.861	Curve	63	High Speed
2306+05.945	Non-Curve	63	High Speed
2302+48.293	Non-Curve	65	High Speed
2294+79.632	Non-Curve	65	High Speed
2279+45.879	Curve	63	High Speed
2256+76.507	Non-Curve	63	High Speed
2256+28.699	Non-Curve	63	High Speed
2249+27.960	Curve	63	High Speed
2233+97.851	Non-Curve	63	High Speed
2229+04.210	Non-Curve	65	High Speed
2207+08.427	Non-Curve	65	High Speed
2192+06.289	Curve	63	High Speed
2182+72.331	Non-Curve	63	High Speed
2179+14.679	Non-Curve	65	High Speed
2168+82.145	Non-Curve	65	High Speed
2164+85.534	Curve	65	High Speed
2122+15.751	Non-Curve	65	High Speed
2121+21.320	Non-Curve	65	High Speed
2077+62.277	Non-Curve	65	High Speed
2067+99.438	Curve	64	High Speed
2052+62.284	Non-Curve	64	High Speed
2050+33.037	Non-Curve	65	High Speed
1919+80.312	Non-Curve	65	High Speed
1904+85.312	Curve	62	High Speed
1893+58.268	Non-Curve	62	High Speed
1889+90.226	Curve	57	High Speed
1884+07.604	Non-Curve	57	High Speed
1875+71.727	Non-Curve	62	High Speed
1857+23.946	Curve	57	High Speed
1852+40.031	Non-Curve	57	High Speed
1850+59.475	Non-Curve	58	High Speed
1846+67.512	Curve	57	High Speed
1836+00.912	Non-Curve	57	High Speed
1826+72.002	Non-Curve	62	High Speed

Station	Segment Type	V85 Speed (mph)	Speed Model
1805+16.197	Curve	57	High Speed
1796+64.739	Non-Curve	57	High Speed
1787+88.934	Curve	65	High Speed
1777+26.252	Non-Curve	65	High Speed
1776+35.076	Non-Curve	65	High Speed
1750+72.663	Non-Curve	65	High Speed
1732+47.637	Curve	62	High Speed
1727+11.379	Non-Curve	62	High Speed
1720+93.250	Curve	57	High Speed
1715+28.063	Non-Curve	57	High Speed
1703+83.776	Non-Curve	63	High Speed
1695+61.079	Curve	62	High Speed
1690+03.213	Non-Curve	62	High Speed
1686+45.340	Non-Curve	63	High Speed
1681+04.530	Curve	62	High Speed
1674+04.477	Non-Curve	62	High Speed
1671+39.898	Non-Curve	64	High Speed
1668+91.391	Curve	63	High Speed
1658+64.069	Non-Curve	63	High Speed
1656+32.149	Non-Curve	64	High Speed
1646+14.198	Curve	63	High Speed
1627+49.440	Non-Curve	63	High Speed
1625+10.773	Non-Curve	64	High Speed
1616+84.156	Curve	63	High Speed
1609+61.022	Non-Curve	63	High Speed
1606+67.009	Non-Curve	64	High Speed
1601+34.699	Curve	64	High Speed
1547+28.434	Non-Curve	64	High Speed
1546+53.978	Non-Curve	64	High Speed
1540+55.785	Curve	63	High Speed
1516+97.763	Non-Curve	63	High Speed
1513+63.578	Non-Curve	65	High Speed
1507+71.247	Non-Curve	65	High Speed
1495+04.091	Curve	62	High Speed
1482+80.502	Non-Curve	62	High Speed
1477+34.500	Non-Curve	65	High Speed
1452+15.675	Non-Curve	65	High Speed
1439+70.975	Curve	62	High Speed
1429+14.849	Non-Curve	62	High Speed
1427+49.833	Non-Curve	63	High Speed
1421+34.750	Curve	62	High Speed
1409+13.059	Non-Curve	62	High Speed
1402+36.769	Non-Curve	65	High Speed
1395+40.919	Non-Curve	65	High Speed
1375+23.561	Curve	63	High Speed
1359+98.149	Non-Curve	63	High Speed
1355+75.006	Curve	60	High Speed
1350+43.605	Non-Curve	60	High Speed
1345+88.891	Curve	63	High Speed
1336+44.302	Non-Curve	63	High Speed
1331+63.979	Non-Curve	65	High Speed
1327+09.000	Non-Curve	65	High Speed

## Design Speed Assumption

Table 5 displays the tabular results of the design speed assumption evaluation for travel in the direction of decreasing stations.

[[Design Speed Assumption Check in the DCM Engineer's Manual](#)]

**Table 5. Design Speed Assumption, Decreasing Stations**

From Station	To Station	Min (mph)	Max (mph)	Condition
2468+96.256	2411+24.465	6	10	2
2411+24.465	2395+03.106	4	6	1
2395+03.106	2394+68.358	6	6	2
2394+68.358	2378+85.222	4	6	1
2378+85.222	2368+94.793	6	8	2
2368+94.793	2366+07.156	0	6	1
2366+07.156	1327+09.000	-13	0	4

### Design Speed Assumption Check Conditions Key

Condition 1:  $0 \text{ mph} \leq (V_{85} - V_{\text{design}}) \leq 6 \text{ mph}$

Condition 2:  $6 \text{ mph} < (V_{85} - V_{\text{design}}) \leq 12 \text{ mph}$

Condition 3:  $12 \text{ mph} < (V_{85} - V_{\text{design}})$

Condition 4:  $(V_{85} - V_{\text{design}}) < 0 \text{ mph}$

where:

$V_{85}$ : estimated 85th percentile operating speed

$V_{\text{design}}$ : design speed

## Speed Differential of Adjacent Design Elements

Table 6 displays the tabular results of the speed differential of adjacent design elements evaluation for travel in the direction of decreasing stations.

[Speed Differential of Adjacent Design Elements Check in the DCM Engineer's Manual]

**Table 6. Speed Differential of Adjacent Design Elements, Decreasing Stations**

Station of Max Speed on Preceding Element	Max Speed on Preceding Element (mph)	Start of Curve	Speed on Curve (mph)	Speed Differential (mph)	Condition
2468+96.256	65	2448+37.898	61	4	1
2434+06.759	65	2408+00.619	59	6	2
2394+88.681	61	2392+14.656	59	2	1
2377+58.254	63	2375+78.706	62	0	1
2363+75.702	65	2317+56.861	63	2	1
2302+48.293	65	2279+45.879	63	2	1
2256+28.699	63	2249+27.960	63	1	1
2229+04.210	65	2192+06.289	63	2	1
2179+14.679	65	2164+85.534	65	0	1
2121+21.320	65	2067+99.438	64	1	1
2050+33.037	65	1904+85.312	62	3	1
1904+85.312	62	1889+90.226	57	4	1
1875+71.727	62	1857+23.946	57	4	1
1850+59.475	58	1846+67.512	57	1	1
1826+72.002	62	1805+16.197	57	5	1
1805+16.197	57	1787+88.934	65	-7	1
1776+35.076	65	1732+47.637	62	3	1
1732+47.637	62	1720+93.250	57	5	1
1703+83.776	63	1695+61.079	62	2	1
1686+45.340	63	1681+04.530	62	1	1
1671+39.898	64	1668+91.391	63	0	1
1656+32.149	64	1646+14.198	63	1	1
1625+10.773	64	1616+84.156	63	1	1
1606+67.009	64	1601+34.699	64	1	1
1546+53.978	64	1540+55.785	63	1	1
1513+63.578	65	1495+04.091	62	3	1
1477+34.500	65	1439+70.975	62	3	1
1427+49.833	63	1421+34.750	62	1	1
1402+36.769	65	1375+23.561	63	2	1
1375+23.561	63	1355+75.006	60	3	1
1355+75.006	60	1345+88.891	63	-3	1

**Speed Differential of Adjacent Design Elements Check Conditions Key**

Condition 1:  $0 \text{ mph} < (V_{85_{\text{Tangent}}} - V_{85_{\text{Curve}}}) \leq 6 \text{ mph}$

Condition 2:  $6 \text{ mph} < (V_{85_{\text{Tangent}}} - V_{85_{\text{Curve}}}) \leq 12 \text{ mph}$

Condition 3:  $12 \text{ mph} < (V85_{\text{Tangent}} - V85_{\text{Curve}})$

where:

$V85_{\text{Tangent}}$ : estimated 85th percentile operating speed on tangent

$V85_{\text{Curve}}$ : estimated 85th percentile operating speed at the beginning of the curve

*Interactive Highway Safety Design Model*

**Design Consistency Evaluation Report**

**P1\_6 Alignment Alternative**

January 5, 2018





## **Disclaimer**

The Interactive Highway Design Model (IHSDM) software is disseminated under the sponsorship of the Department of Transportation in the interest of information exchange. The United States Government assumes no liability for its content or use thereof. This document does not constitute a standard, specification, or regulation.

The United States Government does not endorse products or manufacturers. Trade and manufacturers' names may appear in this software and documentation only because they are considered essential to the objective of the software.

## **Limited Warranty and Limitations of Remedies**

This software product is provided "as-is," without warranty of any kind-either expressed or implied (but not limited to the implied warranties of merchantability and fitness for a particular purpose). The FHWA do not warrant that the functions contained in the software will meet the end-user's requirements or that the operation of the software will be uninterrupted and error-free.

Under no circumstances will the FHWA be liable to the end-user for any damages or claimed lost profits, lost savings, or other incidental or consequential damages rising out of the use or inability to use the software (even if these organizations have been advised of the possibility of such damages), or for any claim by any other party.

## **Notice**

The use of the IHSDM software is being done strictly on a voluntary basis. In exchange for provision of IHSDM, the user agrees that the Federal Highway Administration (FHWA), U.S. Department of Transportation and any other agency of the Federal Government shall not be responsible for any errors, damage or other liability that may result from any and all use of the software, including installation and testing of the software. The user further agrees to hold the FHWA and the Federal Government harmless from any resulting liability. The user agrees that this hold harmless provision shall flow to any person to whom or any entity to which the user provides the IHSDM software. It is the user's full responsibility to inform any person to whom or any entity to which it provides the IHSDM software of this hold harmless provision.

## Table of Contents

<b>Report Overview</b> .....	<b>1</b>
<b>Design Consistency Results, Increasing Stations</b> .....	<b>3</b>
<b>Design Consistency Results, Decreasing Stations</b> .....	<b>9</b>

## List of Tables

Table V85 Speed Profile Coordinates, Increasing Stations .....	4
Table Design Speed Assumption, Increasing Stations .....	6
Table Speed Differential of Adjacent Design Elements, Increasing Stations .....	7
Table V85 Speed Profile Coordinates, Decreasing Stations .....	10
Table Design Speed Assumption, Decreasing Stations .....	12
Table Speed Differential of Adjacent Design Elements, Decreasing Stations .....	13

## List of Figures

Figure Graphical Results, Increasing Stations .....	3
Figure Graphical Results, Decreasing Stations .....	9

## Report Overview

**Report Generated:** Jan 5, 2018 10:01 AM

**Report Template:** System: Multi-Page, by Travel Direction [System] (dcm4, Oct 9, 2017 1:45 PM)

**Evaluation Date:** Fri Jan 05 09:54:12 AKST 2018

**IHSDM Version:** v13.0.0 (Sep 13, 2017)

**Design Consistency Module:** v4.0.0 (Sep 23, 2016)

**User Name:** RaeAnne Hebnes

**Organization Name:** Michael Baker International

**Phone:**

**E-Mail:**

**Project Title:** Parks 305 - 325 v2

**Project Comment:** Created using wizard

**Project Unit System:** U.S. Customary

**Highway Title:** Alignment P1\_6\_1dec2017

**Highway Comment:** Alignment P1\_1dec2017with 6% max grade

**Highway Version:** 1

**Evaluation Title:** Evaluation 9

**Evaluation Comment:** Created Fri Jan 05 09:53:41 AKST 2018

**Minimum Station:** 1327+09.000

**Maximum Station:** 2469+47.035

**Design vs. Operating Speed:** true

**Predicted Speed Differential of Adjacent Elements:** true

**Specify Start/Ends Speeds:** false

**Speed at Evaluation Start (Increasing):** 62 mph

**Speed at Evaluation End (Increasing):** 62 mph

**Speed at Evaluation Start (Decreasing):** 62 mph

**Speed at Evaluation End (Decreasing):** 62 mph

### Run Time Messages

Base speed calculations from 1327+09.000 to 2469+47.035 with high speed model

Predicted 64 speeds

Adjusting 64 speeds for acceleration/deceleration

Testing 104 adjusted speeds for grade limiting.

A total of 0 speeds added or modified due to grade limiting.

Base speed calculations from 2469+47.035 to 1327+09.000 with high speed model

Predicted 64 speeds

Adjusting 64 speeds for acceleration/deceleration

Testing 104 adjusted speeds for grade limiting.

A total of 0 speeds added or modified due to grade limiting.

# Design Consistency Results, Increasing Stations

Figure 1 below displays the graphical results of the Design Consistency Module evaluation for travel the direction of increasing stations.

[Graphical Output in the DCM Engineer's Manual]

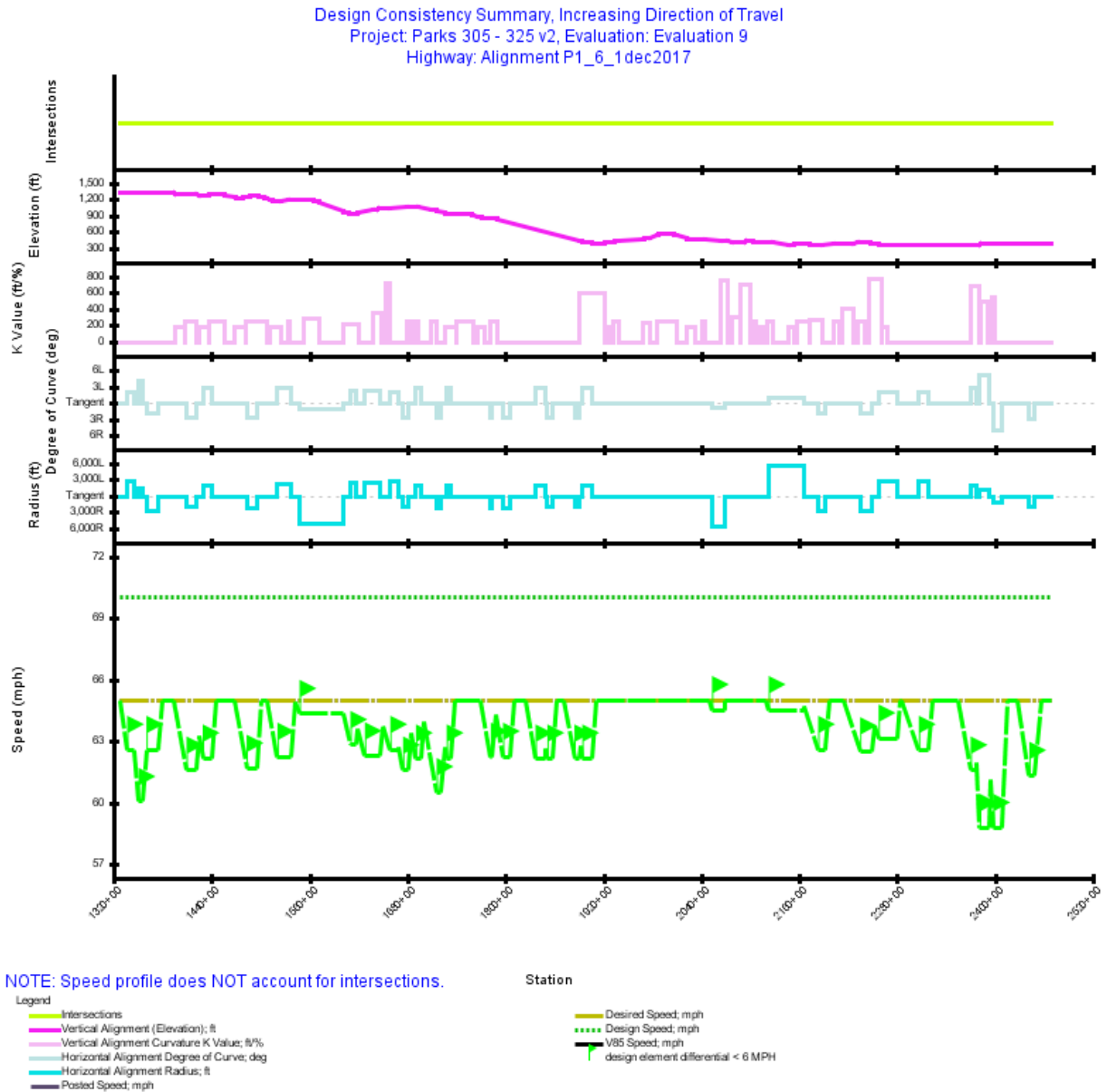

Figure 1. Graphical Results, Increasing Stations

## V85 Speed Profile

Table 1 displays the tabular results of the V85 speed profile evaluation for travel in the direction of increasing stations.

[[V85 Speed Profile in the DCM Engineer's Manual](#)]

**Table 1. V85 Speed Profile Coordinates, Increasing Stations**

Station	Segment Type	V85 Speed (mph)	Speed Model
1327+09.000	Non-Curve	65	High Speed
1336+44.302	Curve	63	High Speed
1345+88.891	Non-Curve	63	High Speed
1350+43.605	Curve	60	High Speed
1355+75.006	Non-Curve	60	High Speed
1359+98.149	Curve	63	High Speed
1375+23.561	Non-Curve	63	High Speed
1380+03.884	Non-Curve	65	High Speed
1394+18.059	Non-Curve	65	High Speed
1409+13.059	Curve	62	High Speed
1421+34.750	Non-Curve	62	High Speed
1424+55.688	Non-Curve	63	High Speed
1429+14.849	Curve	62	High Speed
1439+70.975	Non-Curve	62	High Speed
1445+34.038	Non-Curve	65	High Speed
1467+48.968	Non-Curve	65	High Speed
1482+80.707	Curve	62	High Speed
1495+04.975	Non-Curve	62	High Speed
1501+64.983	Non-Curve	65	High Speed
1508+02.361	Non-Curve	65	High Speed
1520+69.517	Curve	62	High Speed
1537+20.811	Non-Curve	62	High Speed
1542+55.530	Non-Curve	65	High Speed
1547+67.585	Curve	64	High Speed
1601+73.850	Non-Curve	64	High Speed
1610+00.173	Curve	63	High Speed
1617+23.307	Non-Curve	63	High Speed
1618+79.946	Non-Curve	64	High Speed
1627+89.938	Curve	62	High Speed
1646+52.122	Non-Curve	62	High Speed
1649+42.805	Non-Curve	64	High Speed
1659+03.379	Curve	63	High Speed
1669+30.626	Non-Curve	63	High Speed
1669+55.519	Non-Curve	63	High Speed
1674+43.750	Curve	62	High Speed
1681+43.803	Non-Curve	62	High Speed
1685+01.676	Non-Curve	63	High Speed
1690+42.486	Curve	62	High Speed
1696+00.352	Non-Curve	62	High Speed
1699+50.652	Non-Curve	64	High Speed
1715+67.336	Curve	61	High Speed
1721+32.523	Non-Curve	61	High Speed
1725+56.324	Non-Curve	63	High Speed

Station	Segment Type	V85 Speed (mph)	Speed Model
1727+99.101	Curve	62	High Speed
1732+38.832	Non-Curve	62	High Speed
1738+01.895	Non-Curve	65	High Speed
1769+41.083	Non-Curve	65	High Speed
1782+08.239	Curve	62	High Speed
1783+86.769	Non-Curve	62	High Speed
1787+83.707	Non-Curve	64	High Speed
1797+04.916	Curve	62	High Speed
1805+56.375	Non-Curve	62	High Speed
1811+02.377	Non-Curve	65	High Speed
1824+53.015	Non-Curve	65	High Speed
1836+97.715	Curve	62	High Speed
1848+67.739	Non-Curve	62	High Speed
1849+52.960	Non-Curve	63	High Speed
1851+41.349	Curve	62	High Speed
1857+54.083	Non-Curve	62	High Speed
1863+17.146	Non-Curve	65	High Speed
1872+10.341	Non-Curve	65	High Speed
1884+55.041	Curve	62	High Speed
1890+37.663	Non-Curve	62	High Speed
1891+59.441	Non-Curve	63	High Speed
1894+28.643	Curve	62	High Speed
1905+57.352	Non-Curve	62	High Speed
1911+20.415	Non-Curve	65	High Speed
2049+11.808	Non-Curve	65	High Speed
2053+08.501	Curve	65	High Speed
2068+50.198	Non-Curve	65	High Speed
2069+44.649	Non-Curve	65	High Speed
2118+70.045	Non-Curve	65	High Speed
2122+66.738	Curve	65	High Speed
2165+36.208	Non-Curve	65	High Speed
2165+68.195	Non-Curve	65	High Speed
2183+23.204	Curve	63	High Speed
2192+57.094	Non-Curve	63	High Speed
2197+37.417	Non-Curve	65	High Speed
2214+12.800	Non-Curve	65	High Speed
2234+49.053	Curve	63	High Speed
2249+78.454	Non-Curve	63	High Speed
2252+22.918	Non-Curve	64	High Speed
2257+27.920	Curve	63	High Speed
2279+96.243	Non-Curve	63	High Speed
2283+68.140	Non-Curve	65	High Speed
2285+65.677	Non-Curve	65	High Speed
2306+57.050	Curve	63	High Speed
2318+07.600	Non-Curve	63	High Speed
2322+88.045	Non-Curve	65	High Speed
2354+94.689	Non-Curve	65	High Speed
2369+89.689	Curve	62	High Speed
2376+29.630	Non-Curve	62	High Speed
2377+04.917	Non-Curve	62	High Speed
2381+18.255	Curve	59	High Speed
2392+65.999	Non-Curve	59	High Speed



Station	Segment Type	V85 Speed (mph)	Speed Model
2394+78.641	Non-Curve	61	High Speed
2397+77.506	Curve	59	High Speed
2408+51.850	Non-Curve	59	High Speed
2414+39.459	Non-Curve	65	High Speed
2427+88.106	Non-Curve	65	High Speed
2441+82.284	Curve	61	High Speed
2448+88.292	Non-Curve	61	High Speed
2456+13.446	Non-Curve	65	High Speed
2469+47.035	Non-Curve	65	High Speed

## Design Speed Assumption

Table 2 displays the tabular results of the design speed assumption evaluation for travel in the direction of increasing stations.

[[Design Speed Assumption Check in the DCM Engineer's Manual](#)]

**Table 2. Design Speed Assumption, Increasing Stations**

From Station	To Station	Min (mph)	Max (mph)	Condition
1327+09.000	2469+47.035	-11	-5	4

### Design Speed Assumption Check Conditions Key

Condition 1:  $0 \text{ mph} \leq (V_{85} - V_{\text{design}}) \leq 6 \text{ mph}$

Condition 2:  $6 \text{ mph} < (V_{85} - V_{\text{design}}) \leq 12 \text{ mph}$

Condition 3:  $12 \text{ mph} < (V_{85} - V_{\text{design}})$

Condition 4:  $(V_{85} - V_{\text{design}}) < 0 \text{ mph}$

where:

$V_{85}$ : estimated 85th percentile operating speed

$V_{\text{design}}$ : design speed

## Speed Differential of Adjacent Design Elements

Table 3 displays the tabular results of the speed differential of adjacent design elements evaluation for travel in the direction of increasing stations.

[Speed Differential of Adjacent Design Elements Check in the DCM Engineer's Manual]

**Table 3. Speed Differential of Adjacent Design Elements, Increasing Stations**

Station of Max Speed on Preceding Element	Max Speed on Preceding Element (mph)	Start of Curve	Speed on Curve (mph)	Speed Differential (mph)	Condition
1327+09.000	65	1336+44.302	63	2	1
1336+44.302	63	1350+43.605	60	3	1
1350+43.605	60	1359+98.149	63	-3	1
1380+03.884	65	1409+13.059	62	3	1
1424+55.688	63	1429+14.849	62	1	1
1445+34.038	65	1482+80.707	62	3	1
1501+64.983	65	1520+69.517	62	3	1
1542+55.530	65	1547+67.585	64	1	1
1547+67.585	64	1610+00.173	63	2	1
1618+79.946	64	1627+89.938	62	1	1
1649+42.805	64	1659+03.379	63	1	1
1669+55.519	63	1674+43.750	62	1	1
1685+01.676	63	1690+42.486	62	1	1
1699+50.652	64	1715+67.336	61	3	1
1725+56.324	63	1727+99.101	62	1	1
1738+01.895	65	1782+08.239	62	3	1
1787+83.707	64	1797+04.916	62	2	1
1811+02.377	65	1836+97.715	62	3	1
1849+52.960	63	1851+41.349	62	0	1
1863+17.146	65	1884+55.041	62	3	1
1891+59.441	63	1894+28.643	62	1	1
1911+20.415	65	2053+08.501	65	0	1
2069+44.649	65	2122+66.738	65	0	1
2165+68.195	65	2183+23.204	63	2	1
2197+37.417	65	2234+49.053	63	2	1
2252+22.918	64	2257+27.920	63	1	1
2283+68.140	65	2306+57.050	63	2	1
2322+88.045	65	2369+89.689	62	3	1
2377+04.917	62	2381+18.255	59	3	1
2394+78.641	61	2397+77.506	59	2	1
2414+39.459	65	2441+82.284	61	4	1

**Speed Differential of Adjacent Design Elements Check Conditions Key**

Condition 1:  $0 \text{ mph} (V_{85_{\text{Tangent}}} - V_{85_{\text{Curve}}}) \leq 6 \text{ mph}$

Condition 2:  $6 \text{ mph} < (V85_{\text{Tangent}} - V85_{\text{Curve}}) \leq 12 \text{ mph}$

Condition 3:  $12 \text{ mph} < (V85_{\text{Tangent}} - V85_{\text{Curve}})$

where:

$V85_{\text{Tangent}}$ : estimated 85th percentile operating speed on tangent

$V85_{\text{Curve}}$ : estimated 85th percentile operating speed at the beginning of the curve

## Design Consistency Results, Decreasing Stations

Figure 2 below displays the graphical results of the Design Consistency Module evaluation for travel the direction of decreasing stations.

[Graphical Output in the DCM Engineer's Manual]

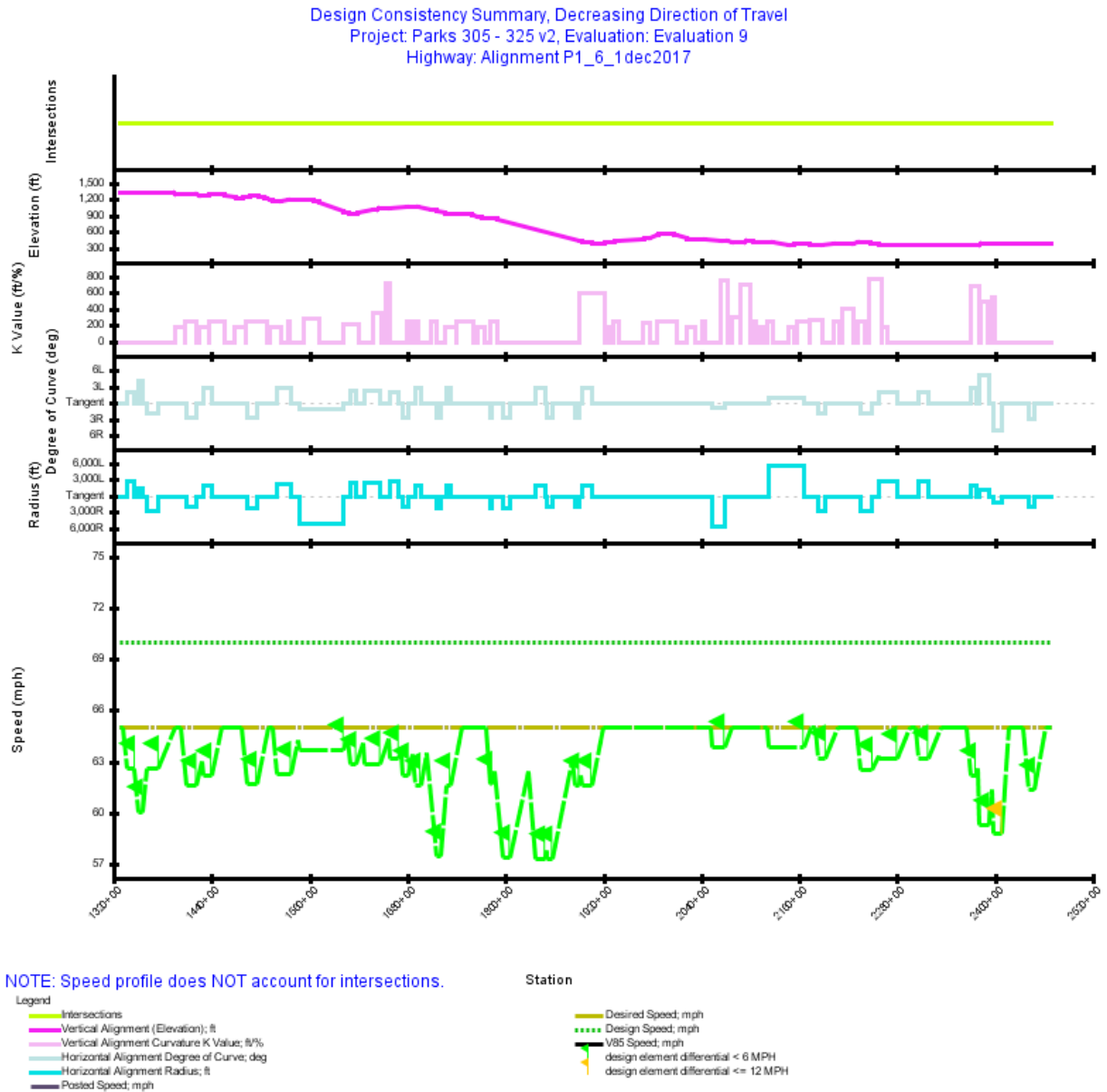

Figure 2. Graphical Results, Decreasing Stations

### V85 Speed Profile

Table 4 displays the tabular results of the V85 speed profile evaluation for travel in the direction of decreasing stations.

[[V85 Speed Profile in the DCM Engineer's Manual](#)]

**Table 4. V85 Speed Profile Coordinates, Decreasing Stations**

Station	Segment Type	V85 Speed (mph)	Speed Model
2469+47.035	Non-Curve	65	High Speed
2462+82.470	Non-Curve	65	High Speed
2448+88.292	Curve	61	High Speed
2441+82.284	Non-Curve	61	High Speed
2434+57.130	Non-Curve	65	High Speed
2416+77.707	Non-Curve	65	High Speed
2408+51.850	Curve	59	High Speed
2397+77.506	Non-Curve	59	High Speed
2395+39.628	Non-Curve	61	High Speed
2392+65.999	Curve	59	High Speed
2381+18.255	Non-Curve	59	High Speed
2378+09.158	Non-Curve	63	High Speed
2376+29.630	Curve	62	High Speed
2369+89.689	Non-Curve	62	High Speed
2364+26.626	Non-Curve	65	High Speed
2333+65.177	Non-Curve	65	High Speed
2318+07.600	Curve	63	High Speed
2306+57.050	Non-Curve	63	High Speed
2302+99.233	Non-Curve	65	High Speed
2295+29.573	Non-Curve	65	High Speed
2279+96.243	Curve	63	High Speed
2257+27.920	Non-Curve	63	High Speed
2256+79.795	Non-Curve	63	High Speed
2249+78.454	Curve	63	High Speed
2234+49.053	Non-Curve	63	High Speed
2229+55.176	Non-Curve	65	High Speed
2207+59.392	Non-Curve	65	High Speed
2192+57.094	Curve	63	High Speed
2183+23.204	Non-Curve	63	High Speed
2179+65.514	Non-Curve	65	High Speed
2174+99.125	Non-Curve	65	High Speed
2165+36.208	Curve	64	High Speed
2122+66.738	Non-Curve	64	High Speed
2120+37.472	Non-Curve	65	High Speed
2078+13.115	Non-Curve	65	High Speed
2068+50.198	Curve	64	High Speed
2053+08.501	Non-Curve	64	High Speed
2050+79.235	Non-Curve	65	High Speed
1920+52.352	Non-Curve	65	High Speed
1905+57.352	Curve	62	High Speed
1894+28.643	Non-Curve	62	High Speed
1893+06.865	Non-Curve	62	High Speed
1890+37.663	Curve	62	High Speed

Station	Segment Type	V85 Speed (mph)	Speed Model
1884+55.041	Non-Curve	62	High Speed
1881+61.104	Non-Curve	63	High Speed
1857+54.083	Curve	57	High Speed
1851+41.349	Non-Curve	57	High Speed
1850+56.128	Non-Curve	58	High Speed
1848+67.739	Curve	57	High Speed
1836+97.715	Non-Curve	57	High Speed
1827+43.602	Non-Curve	62	High Speed
1805+56.375	Curve	57	High Speed
1797+04.916	Non-Curve	57	High Speed
1787+49.205	Non-Curve	62	High Speed
1783+86.769	Curve	62	High Speed
1782+08.239	Non-Curve	62	High Speed
1775+48.231	Non-Curve	65	High Speed
1747+33.832	Non-Curve	65	High Speed
1732+38.832	Curve	62	High Speed
1727+99.101	Non-Curve	62	High Speed
1721+32.523	Curve	57	High Speed
1715+67.336	Non-Curve	57	High Speed
1704+23.049	Non-Curve	63	High Speed
1696+00.352	Curve	62	High Speed
1690+42.486	Non-Curve	62	High Speed
1686+84.613	Non-Curve	63	High Speed
1681+43.803	Curve	62	High Speed
1674+43.750	Non-Curve	62	High Speed
1671+79.195	Non-Curve	64	High Speed
1669+30.626	Curve	63	High Speed
1659+03.379	Non-Curve	63	High Speed
1656+71.096	Non-Curve	64	High Speed
1646+52.122	Curve	63	High Speed
1627+89.938	Non-Curve	63	High Speed
1625+50.340	Non-Curve	64	High Speed
1617+23.307	Curve	63	High Speed
1610+00.173	Non-Curve	63	High Speed
1607+06.160	Non-Curve	64	High Speed
1601+73.850	Curve	64	High Speed
1547+67.585	Non-Curve	64	High Speed
1546+47.901	Non-Curve	64	High Speed
1537+20.811	Curve	62	High Speed
1520+69.517	Non-Curve	62	High Speed
1515+23.515	Non-Curve	65	High Speed
1510+36.714	Non-Curve	65	High Speed
1495+04.975	Curve	62	High Speed
1482+80.707	Non-Curve	62	High Speed
1476+20.699	Non-Curve	65	High Speed
1452+15.675	Non-Curve	65	High Speed
1439+70.975	Curve	62	High Speed
1429+14.849	Non-Curve	62	High Speed
1427+49.833	Non-Curve	63	High Speed
1421+34.750	Curve	62	High Speed
1409+13.059	Non-Curve	62	High Speed
1402+36.769	Non-Curve	65	High Speed

Station	Segment Type	V85 Speed (mph)	Speed Model
1395+40.919	Non-Curve	65	High Speed
1375+23.561	Curve	63	High Speed
1359+98.149	Non-Curve	63	High Speed
1355+75.006	Curve	60	High Speed
1350+43.605	Non-Curve	60	High Speed
1345+88.891	Curve	63	High Speed
1336+44.302	Non-Curve	63	High Speed
1331+63.979	Non-Curve	65	High Speed
1327+09.000	Non-Curve	65	High Speed

## Design Speed Assumption

Table 5 displays the tabular results of the design speed assumption evaluation for travel in the direction of decreasing stations.

[\[Design Speed Assumption Check in the DCM Engineer's Manual\]](#)

**Table 5. Design Speed Assumption, Decreasing Stations**

From Station	To Station	Min (mph)	Max (mph)	Condition
2469+47.035	1327+09.000	-13	-5	4

### Design Speed Assumption Check Conditions Key

Condition 1:  $0 \text{ mph} \leq (V_{85} - V_{\text{design}}) \leq 6 \text{ mph}$

Condition 2:  $6 \text{ mph} < (V_{85} - V_{\text{design}}) \leq 12 \text{ mph}$

Condition 3:  $12 \text{ mph} < (V_{85} - V_{\text{design}})$

Condition 4:  $(V_{85} - V_{\text{design}}) < 0 \text{ mph}$

where:

$V_{85}$ : estimated 85th percentile operating speed

$V_{\text{design}}$ : design speed

## Speed Differential of Adjacent Design Elements

Table 6 displays the tabular results of the speed differential of adjacent design elements evaluation for travel in the direction of decreasing stations.

[Speed Differential of Adjacent Design Elements Check in the DCM Engineer's Manual]

**Table 6. Speed Differential of Adjacent Design Elements, Decreasing Stations**

Station of Max Speed on Preceding Element	Max Speed on Preceding Element (mph)	Start of Curve	Speed on Curve (mph)	Speed Differential (mph)	Condition
2469+47.035	65	2448+88.292	61	4	1
2434+57.130	65	2408+51.850	59	6	2
2395+39.628	61	2392+65.999	59	2	1
2378+09.158	63	2376+29.630	62	0	1
2364+26.626	65	2318+07.600	63	2	1
2302+99.233	65	2279+96.243	63	2	1
2256+79.795	63	2249+78.454	63	1	1
2229+55.176	65	2192+57.094	63	2	1
2179+65.514	65	2165+36.208	64	1	1
2120+37.472	65	2068+50.198	64	1	1
2050+79.235	65	1905+57.352	62	3	1
1893+06.865	62	1890+37.663	62	1	1
1881+61.104	63	1857+54.083	57	6	1
1850+56.128	58	1848+67.739	57	0	1
1827+43.602	62	1805+56.375	57	5	1
1787+49.205	62	1783+86.769	62	1	1
1775+48.231	65	1732+38.832	62	3	1
1732+38.832	62	1721+32.523	57	4	1
1704+23.049	63	1696+00.352	62	2	1
1686+84.613	63	1681+43.803	62	1	1
1671+79.195	64	1669+30.626	63	0	1
1656+71.096	64	1646+52.122	63	2	1
1625+50.340	64	1617+23.307	63	1	1
1607+06.160	64	1601+73.850	64	1	1
1546+47.901	64	1537+20.811	62	2	1
1515+23.515	65	1495+04.975	62	3	1
1476+20.699	65	1439+70.975	62	3	1
1427+49.833	63	1421+34.750	62	1	1
1402+36.769	65	1375+23.561	63	2	1
1375+23.561	63	1355+75.006	60	3	1
1355+75.006	60	1345+88.891	63	-3	1

**Speed Differential of Adjacent Design Elements Check Conditions Key**

Condition 1:  $0 \text{ mph} (V_{85_{\text{Tangent}}} - V_{85_{\text{Curve}}}) \leq 6 \text{ mph}$



Condition 2:  $6 \text{ mph} < (V85_{\text{Tangent}} - V85_{\text{Curve}}) \leq 12 \text{ mph}$

Condition 3:  $12 \text{ mph} < (V85_{\text{Tangent}} - V85_{\text{Curve}})$

where:

$V85_{\text{Tangent}}$ : estimated 85th percentile operating speed on tangent

$V85_{\text{Curve}}$ : estimated 85th percentile operating speed at the beginning of the curve

*Interactive Highway Safety Design Model*

**Design Consistency Evaluation Report**

**P2 Alignment Alternative**

January 4, 2018



## **Disclaimer**

The Interactive Highway Design Model (IHSDM) software is disseminated under the sponsorship of the Department of Transportation in the interest of information exchange. The United States Government assumes no liability for its content or use thereof. This document does not constitute a standard, specification, or regulation.

The United States Government does not endorse products or manufacturers. Trade and manufacturers' names may appear in this software and documentation only because they are considered essential to the objective of the software.

## **Limited Warranty and Limitations of Remedies**

This software product is provided "as-is," without warranty of any kind-either expressed or implied (but not limited to the implied warranties of merchantability and fitness for a particular purpose). The FHWA do not warrant that the functions contained in the software will meet the end-user's requirements or that the operation of the software will be uninterrupted and error-free.

Under no circumstances will the FHWA be liable to the end-user for any damages or claimed lost profits, lost savings, or other incidental or consequential damages rising out of the use or inability to use the software (even if these organizations have been advised of the possibility of such damages), or for any claim by any other party.

## **Notice**

The use of the IHSDM software is being done strictly on a voluntary basis. In exchange for provision of IHSDM, the user agrees that the Federal Highway Administration (FHWA), U.S. Department of Transportation and any other agency of the Federal Government shall not be responsible for any errors, damage or other liability that may result from any and all use of the software, including installation and testing of the software. The user further agrees to hold the FHWA and the Federal Government harmless from any resulting liability. The user agrees that this hold harmless provision shall flow to any person to whom or any entity to which the user provides the IHSDM software. It is the user's full responsibility to inform any person to whom or any entity to which it provides the IHSDM software of this hold harmless provision.

---

---

## Table of Contents

<b>Report Overview</b> .....	<b>1</b>
<b>Design Consistency Results, Increasing Stations</b> .....	<b>3</b>
<b>Design Consistency Results, Decreasing Stations</b> .....	<b>10</b>

## List of Tables

Table V85 Speed Profile Coordinates, Increasing Stations .....	4
Table Design Speed Assumption, Increasing Stations .....	6
Table Speed Differential of Adjacent Design Elements, Increasing Stations .....	8
Table V85 Speed Profile Coordinates, Decreasing Stations .....	11
Table Design Speed Assumption, Decreasing Stations .....	13
Table Speed Differential of Adjacent Design Elements, Decreasing Stations .....	15

## List of Figures

Figure Graphical Results, Increasing Stations .....	3
Figure Graphical Results, Decreasing Stations .....	10

## Report Overview

**Report Generated:** Jan 4, 2018 9:10 AM

**Report Template:** System: Multi-Page, by Travel Direction [System] (dcm4, Oct 9, 2017 1:45 PM)

**Evaluation Date:** Thu Jan 04 09:10:16 AKST 2018

**IHSDM Version:** v13.0.0 (Sep 13, 2017)

**Design Consistency Module:** v4.0.0 (Sep 23, 2016)

**User Name:** RaeAnne Hebnes

**Organization Name:** Michael Baker International

**Phone:**

**E-Mail:**

**Project Title:** Parks 305 - 325 v2

**Project Comment:** Created using wizard

**Project Unit System:** U.S. Customary

**Highway Title:** Alignment P2\_1dec2017

**Highway Comment:** Alignment P2\_1dec2017

**Highway Version:** 1

**Evaluation Title:** Evaluation 6

**Evaluation Comment:** Created Thu Jan 04 09:10:11 AKST 2018

**Minimum Station:** 1327+09.000

**Maximum Station:** 2424+38.143

**Design vs. Operating Speed:** true

**Predicted Speed Differential of Adjacent Elements:** true

**Specify Start/Ends Speeds:** false

**Speed at Evaluation Start (Increasing):** 62 mph

**Speed at Evaluation End (Increasing):** 62 mph

**Speed at Evaluation Start (Decreasing):** 62 mph

**Speed at Evaluation End (Decreasing):** 62 mph

### Run Time Messages

Base speed calculations from 1327+09.000 to 2424+38.143 with high speed model

Predicted 72 speeds

Adjusting 72 speeds for acceleration/deceleration

Testing 108 adjusted speeds for grade limiting.

A total of 0 speeds added or modified due to grade limiting.

Base speed calculations from 2424+38.143 to 1327+09.000 with high speed model

Predicted 72 speeds

Adjusting 72 speeds for acceleration/deceleration

Testing 106 adjusted speeds for grade limiting.

A total of 0 speeds added or modified due to grade limiting.

# Design Consistency Results, Increasing Stations

Figure 1 below displays the graphical results of the Design Consistency Module evaluation for travel the direction of increasing stations.

[Graphical Output in the DCM Engineer's Manual]

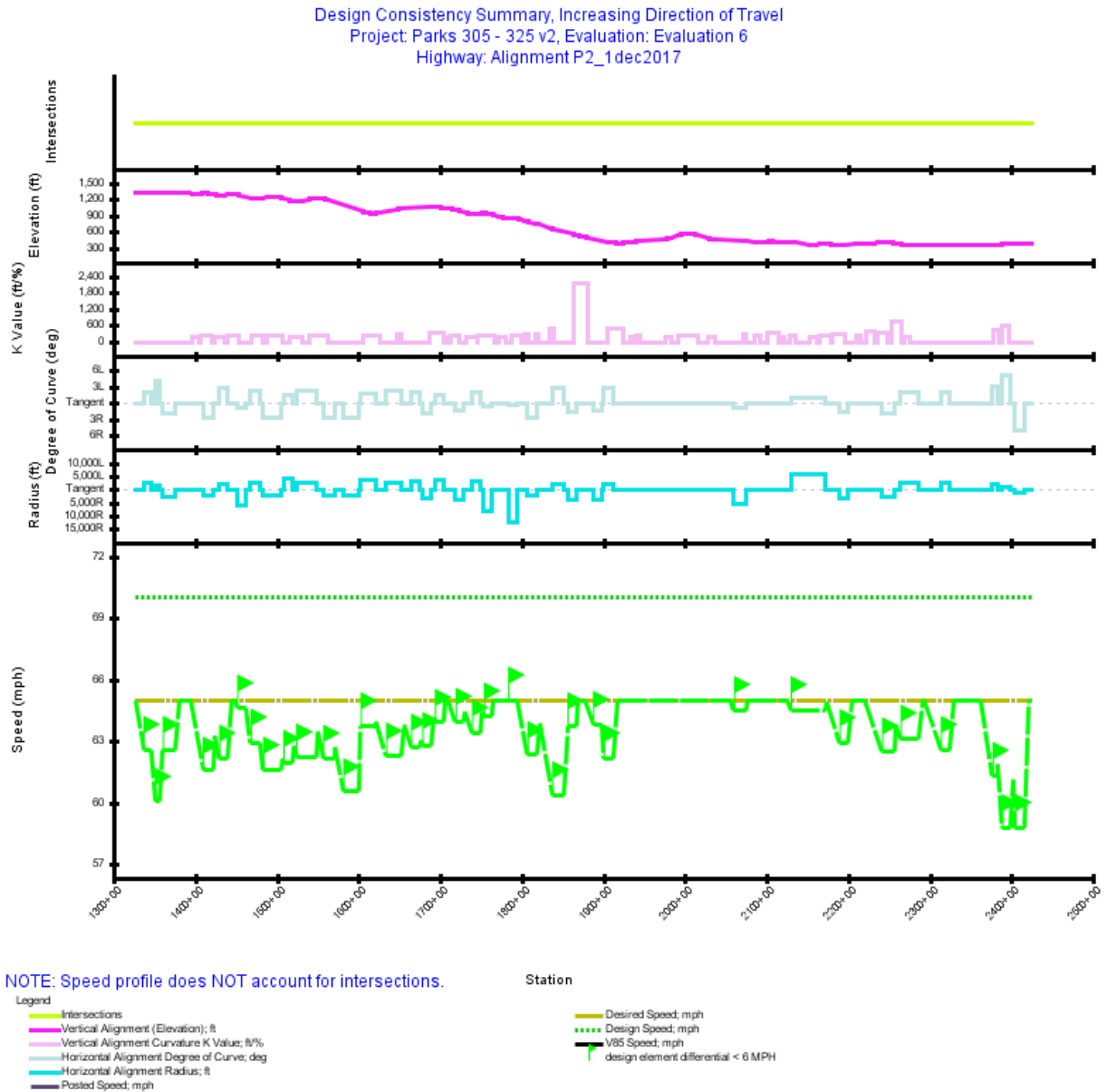

**Figure 1. Graphical Results, Increasing Stations**

## V85 Speed Profile



Table 1 displays the tabular results of the V85 speed profile evaluation for travel in the direction of increasing stations.

[[V85 Speed Profile in the DCM Engineer's Manual](#)]

**Table 1. V85 Speed Profile Coordinates, Increasing Stations**

Station	Segment Type	V85 Speed (mph)	Speed Model
1327+09.000	Non-Curve	65	High Speed
1336+44.302	Curve	63	High Speed
1345+88.891	Non-Curve	63	High Speed
1350+43.605	Curve	60	High Speed
1355+75.006	Non-Curve	60	High Speed
1359+98.149	Curve	63	High Speed
1375+23.561	Non-Curve	63	High Speed
1380+03.884	Non-Curve	65	High Speed
1394+18.059	Non-Curve	65	High Speed
1409+13.059	Curve	62	High Speed
1421+34.750	Non-Curve	62	High Speed
1424+55.645	Non-Curve	63	High Speed
1429+14.713	Curve	62	High Speed
1439+70.699	Non-Curve	62	High Speed
1445+33.762	Non-Curve	65	High Speed
1448+04.555	Non-Curve	65	High Speed
1451+33.375	Curve	65	High Speed
1461+98.062	Non-Curve	65	High Speed
1467+73.811	Curve	63	High Speed
1478+43.352	Non-Curve	63	High Speed
1483+12.985	Curve	62	High Speed
1505+09.701	Non-Curve	62	High Speed
1506+15.485	Non-Curve	62	High Speed
1507+88.933	Curve	62	High Speed
1518+44.144	Non-Curve	62	High Speed
1520+10.480	Non-Curve	63	High Speed
1523+64.397	Curve	62	High Speed
1548+64.398	Non-Curve	62	High Speed
1551+06.010	Non-Curve	63	High Speed
1556+63.827	Curve	62	High Speed
1570+18.580	Non-Curve	62	High Speed
1571+23.710	Non-Curve	63	High Speed
1581+42.155	Curve	61	High Speed
1600+40.495	Non-Curve	61	High Speed
1602+30.336	Curve	64	High Speed
1621+46.738	Non-Curve	64	High Speed
1621+91.876	Non-Curve	64	High Speed
1633+46.402	Curve	62	High Speed
1652+11.160	Non-Curve	62	High Speed
1655+14.362	Non-Curve	64	High Speed
1664+36.565	Curve	63	High Speed
1675+12.295	Non-Curve	63	High Speed
1675+83.893	Non-Curve	63	High Speed

Station	Segment Type	V85 Speed (mph)	Speed Model
1678+20.135	Curve	63	High Speed
1688+79.987	Non-Curve	63	High Speed
1691+49.503	Non-Curve	64	High Speed
1693+40.960	Curve	64	High Speed
1704+03.820	Non-Curve	64	High Speed
1706+22.440	Non-Curve	65	High Speed
1709+95.746	Non-Curve	65	High Speed
1718+73.301	Curve	64	High Speed
1729+24.812	Non-Curve	64	High Speed
1730+22.287	Non-Curve	64	High Speed
1738+90.122	Curve	63	High Speed
1749+60.945	Non-Curve	63	High Speed
1751+63.459	Non-Curve	64	High Speed
1753+37.825	Curve	64	High Speed
1763+99.822	Non-Curve	64	High Speed
1765+56.917	Non-Curve	65	High Speed
1783+38.648	Curve	65	High Speed
1793+95.145	Non-Curve	65	High Speed
1806+82.524	Curve	62	High Speed
1819+02.306	Non-Curve	62	High Speed
1822+08.475	Non-Curve	64	High Speed
1837+12.472	Curve	60	High Speed
1852+14.359	Non-Curve	60	High Speed
1855+90.269	Curve	64	High Speed
1866+66.290	Non-Curve	64	High Speed
1869+17.117	Non-Curve	65	High Speed
1877+11.899	Non-Curve	65	High Speed
1887+17.885	Curve	64	High Speed
1897+69.447	Non-Curve	64	High Speed
1900+15.731	Curve	62	High Speed
1911+44.501	Non-Curve	62	High Speed
1917+07.564	Non-Curve	65	High Speed
2055+94.436	Non-Curve	65	High Speed
2059+91.129	Curve	65	High Speed
2075+32.995	Non-Curve	65	High Speed
2076+27.446	Non-Curve	65	High Speed
2125+52.843	Non-Curve	65	High Speed
2129+49.536	Curve	65	High Speed
2172+19.006	Non-Curve	65	High Speed
2172+90.318	Non-Curve	65	High Speed
2189+34.430	Curve	63	High Speed
2200+10.193	Non-Curve	63	High Speed
2204+24.787	Non-Curve	65	High Speed
2220+94.337	Non-Curve	65	High Speed
2241+30.583	Curve	63	High Speed
2256+59.979	Non-Curve	63	High Speed
2259+04.445	Non-Curve	64	High Speed
2264+09.452	Curve	63	High Speed
2286+77.767	Non-Curve	63	High Speed
2290+49.666	Non-Curve	65	High Speed
2292+47.205	Non-Curve	65	High Speed
2313+38.578	Curve	63	High Speed

Station	Segment Type	V85 Speed (mph)	Speed Model
2324+89.129	Non-Curve	63	High Speed
2329+69.574	Non-Curve	65	High Speed
2363+01.360	Non-Curve	65	High Speed
2376+93.270	Curve	61	High Speed
2382+89.464	Non-Curve	61	High Speed
2383+98.195	Non-Curve	62	High Speed
2388+00.142	Curve	59	High Speed
2399+47.886	Non-Curve	59	High Speed
2401+60.528	Non-Curve	61	High Speed
2404+59.393	Curve	59	High Speed
2415+33.737	Non-Curve	59	High Speed
2421+21.346	Non-Curve	65	High Speed
2424+38.143	Non-Curve	65	High Speed

## Design Speed Assumption

Table 2 displays the tabular results of the design speed assumption evaluation for travel in the direction of increasing stations.

[[Design Speed Assumption Check in the DCM Engineer's Manual](#)]

**Table 2. Design Speed Assumption, Increasing Stations**

From Station	To Station	Min (mph)	Max (mph)	Condition
1327+09.000	2424+38.143	-11	-5	4

### Design Speed Assumption Check Conditions Key

Condition 1:  $0 \text{ mph} \leq (V_{85} - V_{\text{design}}) \leq 6 \text{ mph}$

Condition 2:  $6 \text{ mph} < (V_{85} - V_{\text{design}}) \leq 12 \text{ mph}$

Condition 3:  $12 \text{ mph} < (V_{85} - V_{\text{design}})$

Condition 4:  $(V_{85} - V_{\text{design}}) < 0 \text{ mph}$

where:

$V_{85}$ : estimated 85th percentile operating speed

$V_{\text{design}}$ : design speed

## **Speed Differential of Adjacent Design Elements**

Table 3 displays the tabular results of the speed differential of adjacent design elements evaluation for travel in the direction of increasing stations.

[\[Speed Differential of Adjacent Design Elements Check in the DCM Engineer's Manual\]](#)

**Table 3. Speed Differential of Adjacent Design Elements, Increasing Stations**

Station of Max Speed on Preceding Element	Max Speed on Preceding Element (mph)	Start of Curve	Speed on Curve (mph)	Speed Differential (mph)	Condition
1327+09.000	65	1336+44.302	63	2	1
1336+44.302	63	1350+43.605	60	3	1
1350+43.605	60	1359+98.149	63	-3	1
1380+03.884	65	1409+13.059	62	3	1
1424+55.645	63	1429+14.713	62	1	1
1445+33.762	65	1451+33.375	65	0	1
1451+33.375	65	1467+73.811	63	2	1
1467+73.811	63	1483+12.985	62	1	1
1506+15.485	62	1507+88.933	62	0	1
1520+10.480	63	1523+64.397	62	1	1
1551+06.010	63	1556+63.827	62	1	1
1571+23.710	63	1581+42.155	61	2	1
1581+42.155	61	1602+30.336	64	-3	1
1621+91.876	64	1633+46.402	62	2	1
1655+14.362	64	1664+36.565	63	1	1
1675+83.893	63	1678+20.135	63	0	1
1691+49.503	64	1693+40.960	64	0	1
1706+22.440	65	1718+73.301	64	1	1
1730+22.287	64	1738+90.122	63	1	1
1751+63.459	64	1753+37.825	64	0	1
1765+56.917	65	1783+38.648	65	0	1
1783+38.648	65	1806+82.524	62	3	1
1822+08.475	64	1837+12.472	60	4	1
1837+12.472	60	1855+90.269	64	-3	1
1869+17.117	65	1887+17.885	64	1	1
1887+17.885	64	1900+15.731	62	2	1
1917+07.564	65	2059+91.129	65	0	1
2076+27.446	65	2129+49.536	65	0	1
2172+90.318	65	2189+34.430	63	2	1
2204+24.787	65	2241+30.583	63	2	1
2259+04.445	64	2264+09.452	63	1	1
2290+49.666	65	2313+38.578	63	2	1
2329+69.574	65	2376+93.270	61	4	1
2383+98.195	62	2388+00.142	59	3	1
2401+60.528	61	2404+59.393	59	2	1

**Speed Differential of Adjacent Design Elements Check Conditions Key**Condition 1:  $0 \text{ mph} (V_{85_{\text{Tangent}}} - V_{85_{\text{Curve}}}) \leq 6 \text{ mph}$ Condition 2:  $6 \text{ mph} < (V_{85_{\text{Tangent}}} - V_{85_{\text{Curve}}}) \leq 12 \text{ mph}$

Condition 3:  $12 \text{ mph} < (V85_{\text{Tangent}} - V85_{\text{Curve}})$

where:

$V85_{\text{Tangent}}$ : estimated 85th percentile operating speed on tangent

$V85_{\text{Curve}}$ : estimated 85th percentile operating speed at the beginning of the curve

## Design Consistency Results, Decreasing Stations

Figure 2 below displays the graphical results of the Design Consistency Module evaluation for travel the direction of decreasing stations.

[Graphical Output in the DCM Engineer's Manual]

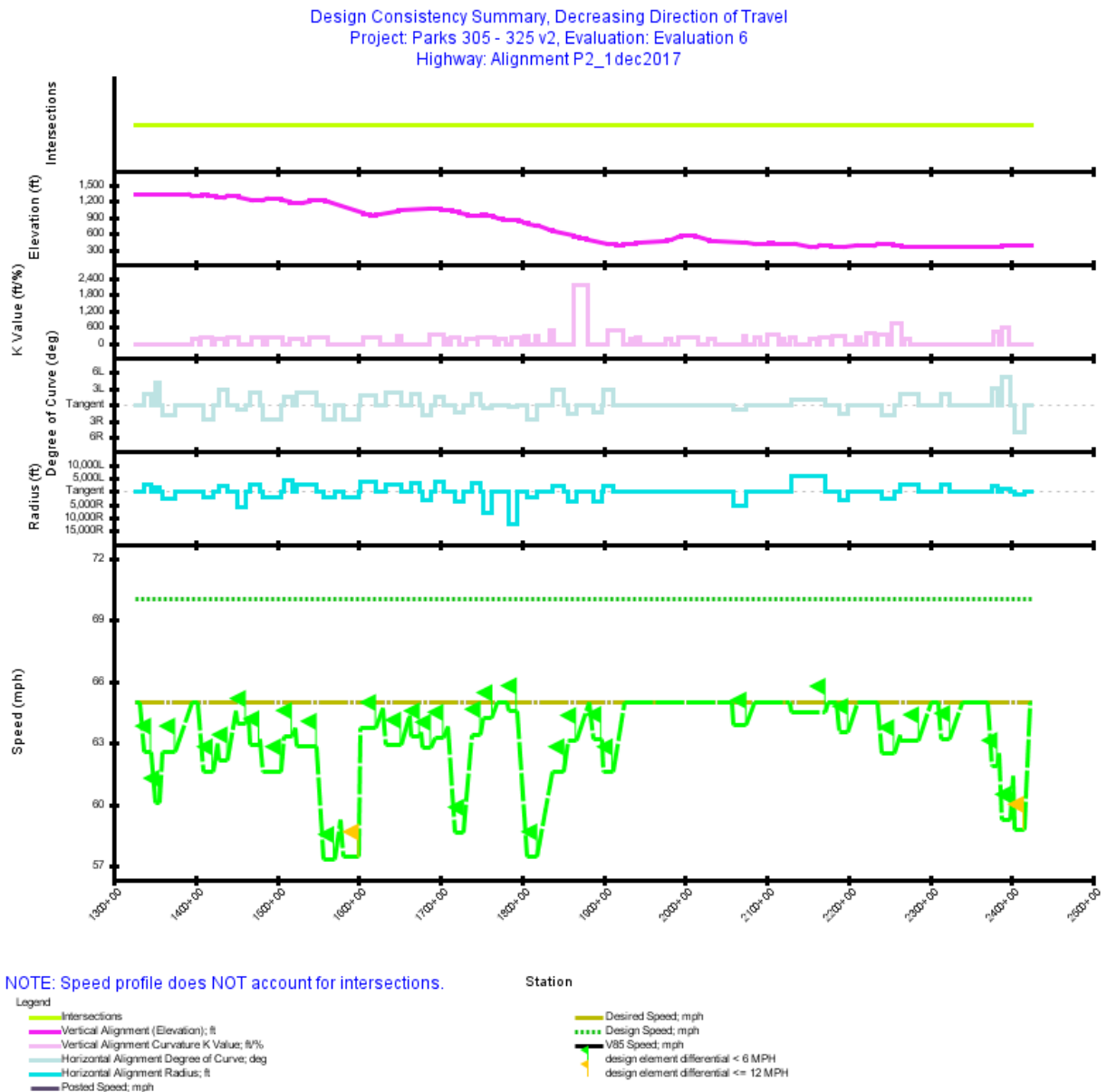

Figure 2. Graphical Results, Decreasing Stations

### V85 Speed Profile

Table 4 displays the tabular results of the V85 speed profile evaluation for travel in the direction of decreasing stations.

[[V85 Speed Profile in the DCM Engineer's Manual](#)]

**Table 4. V85 Speed Profile Coordinates, Decreasing Stations**

Station	Segment Type	V85 Speed (mph)	Speed Model
2424+38.143	Non-Curve	65	High Speed
2423+59.594	Non-Curve	65	High Speed
2415+33.737	Curve	59	High Speed
2404+59.393	Non-Curve	59	High Speed
2402+21.515	Non-Curve	61	High Speed
2399+47.886	Curve	59	High Speed
2388+00.142	Non-Curve	59	High Speed
2385+02.117	Non-Curve	62	High Speed
2382+89.464	Curve	62	High Speed
2376+93.270	Non-Curve	62	High Speed
2370+77.781	Non-Curve	65	High Speed
2340+46.706	Non-Curve	65	High Speed
2324+89.129	Curve	63	High Speed
2313+38.578	Non-Curve	63	High Speed
2309+80.761	Non-Curve	65	High Speed
2302+11.094	Non-Curve	65	High Speed
2286+77.767	Curve	63	High Speed
2264+09.452	Non-Curve	63	High Speed
2263+61.325	Non-Curve	63	High Speed
2256+59.979	Curve	63	High Speed
2241+30.583	Non-Curve	63	High Speed
2236+36.705	Non-Curve	65	High Speed
2212+23.092	Non-Curve	65	High Speed
2200+10.193	Curve	64	High Speed
2189+34.430	Non-Curve	64	High Speed
2186+45.645	Non-Curve	65	High Speed
2176+15.699	Non-Curve	65	High Speed
2172+19.006	Curve	65	High Speed
2129+49.536	Non-Curve	65	High Speed
2128+55.085	Non-Curve	65	High Speed
2084+95.912	Non-Curve	65	High Speed
2075+32.995	Curve	64	High Speed
2059+91.129	Non-Curve	64	High Speed
2057+61.863	Non-Curve	65	High Speed
1926+39.501	Non-Curve	65	High Speed
1911+44.501	Curve	62	High Speed
1900+15.731	Non-Curve	62	High Speed
1897+69.447	Curve	63	High Speed
1887+17.885	Non-Curve	63	High Speed
1883+50.280	Non-Curve	65	High Speed
1882+55.524	Non-Curve	65	High Speed
1866+66.290	Curve	63	High Speed
1855+90.269	Non-Curve	63	High Speed



Station	Segment Type	V85 Speed (mph)	Speed Model
1852+14.359	Curve	62	High Speed
1837+12.472	Non-Curve	62	High Speed
1819+02.306	Curve	57	High Speed
1806+82.524	Non-Curve	57	High Speed
1793+95.145	Curve	65	High Speed
1783+38.648	Non-Curve	65	High Speed
1782+49.322	Non-Curve	65	High Speed
1770+59.622	Non-Curve	65	High Speed
1763+99.822	Curve	64	High Speed
1753+37.825	Non-Curve	64	High Speed
1749+60.945	Curve	63	High Speed
1738+90.122	Non-Curve	63	High Speed
1729+24.812	Curve	59	High Speed
1718+73.301	Non-Curve	59	High Speed
1708+78.251	Non-Curve	64	High Speed
1704+03.820	Curve	63	High Speed
1693+40.960	Non-Curve	63	High Speed
1688+79.987	Curve	63	High Speed
1678+20.135	Non-Curve	63	High Speed
1676+73.409	Non-Curve	64	High Speed
1675+12.295	Curve	63	High Speed
1664+36.565	Non-Curve	63	High Speed
1662+28.337	Non-Curve	64	High Speed
1652+11.160	Curve	63	High Speed
1633+46.402	Non-Curve	63	High Speed
1629+77.568	Non-Curve	65	High Speed
1621+46.738	Curve	64	High Speed
1602+30.336	Non-Curve	64	High Speed
1600+40.495 *	Curve *	57 *	High Speed *
1581+42.155	Non-Curve	57	High Speed
1578+08.107	Non-Curve	59	High Speed
1570+18.580	Curve	57	High Speed
1556+63.827	Non-Curve	57	High Speed
1548+64.398	Curve	63	High Speed
1523+64.397	Non-Curve	63	High Speed
1521+80.485	Non-Curve	64	High Speed
1518+44.144	Curve	63	High Speed
1507+88.933	Non-Curve	63	High Speed
1505+09.701	Curve	62	High Speed
1483+12.985	Non-Curve	62	High Speed
1480+02.758	Non-Curve	63	High Speed
1478+43.352	Curve	63	High Speed
1467+73.811	Non-Curve	63	High Speed
1465+04.150	Non-Curve	64	High Speed
1461+98.062	Curve	64	High Speed
1451+33.375	Non-Curve	64	High Speed
1450+11.675	Non-Curve	65	High Speed
1439+70.699	Curve	62	High Speed
1429+14.713	Non-Curve	62	High Speed
1427+49.739	Non-Curve	63	High Speed
1421+34.750	Curve	62	High Speed
1409+13.059	Non-Curve	62	High Speed

Station	Segment Type	V85 Speed (mph)	Speed Model
1402+36.769	Non-Curve	65	High Speed
1395+40.919	Non-Curve	65	High Speed
1375+23.561	Curve	63	High Speed
1359+98.149	Non-Curve	63	High Speed
1355+75.006	Curve	60	High Speed
1350+43.605	Non-Curve	60	High Speed
1345+88.891	Curve	63	High Speed
1336+44.302	Non-Curve	63	High Speed
1331+63.979	Non-Curve	65	High Speed
1327+09.000	Non-Curve	65	High Speed

\* The deceleration rate predicted for the range(s): [1602+30.336 to 1600+40.495] (in the direction of decreasing stations) is greater than the approximated comfortable deceleration rate, as determined by data collected to develop the Design Consistency Module (as referenced in FHWA Report FHWA-RD-99-171, "Speed prediction for Two-Lane Rural Highways"). See [V85 Speed Profile Coordinates of the Design Consistency Module Engineer's Manual](#) for additional information.

**Design Speed Assumption**

Table 5 displays the tabular results of the design speed assumption evaluation for travel in the direction of decreasing stations.

[\[Design Speed Assumption Check in the DCM Engineer's Manual\]](#)

**Table 5. Design Speed Assumption, Decreasing Stations**

From Station	To Station	Min (mph)	Max (mph)	Condition
2424+38.143	1327+09.000	-13	-5	4

**Design Speed Assumption Check Conditions Key**

Condition 1:  $0 \text{ mph} \leq (V_{85} - V_{\text{design}}) \leq 6 \text{ mph}$

Condition 2:  $6 \text{ mph} < (V_{85} - V_{\text{design}}) \leq 12 \text{ mph}$

Condition 3:  $12 \text{ mph} < (V_{85} - V_{\text{design}})$

Condition 4:  $(V_{85} - V_{\text{design}}) < 0 \text{ mph}$

where:

V85: estimated 85th percentile operating speed

V<sub>design</sub>: design speed

## **Speed Differential of Adjacent Design Elements**

Table 6 displays the tabular results of the speed differential of adjacent design elements evaluation for travel in the direction of decreasing stations.

[[Speed Differential of Adjacent Design Elements Check in the DCM Engineer's Manual](#)]

**Table 6. Speed Differential of Adjacent Design Elements, Decreasing Stations**

Station of Max Speed on Preceding Element	Max Speed on Preceding Element (mph)	Start of Curve	Speed on Curve (mph)	Speed Differential (mph)	Condition
2424+38.143	65	2415+33.737	59	6	2
2402+21.515	61	2399+47.886	59	2	1
2385+02.117	62	2382+89.464	62	1	1
2370+77.781	65	2324+89.129	63	2	1
2309+80.761	65	2286+77.767	63	2	1
2263+61.325	63	2256+59.979	63	1	1
2236+36.705	65	2200+10.193	64	1	1
2186+45.645	65	2172+19.006	65	0	1
2128+55.085	65	2075+32.995	64	1	1
2057+61.863	65	1911+44.501	62	3	1
1911+44.501	62	1897+69.447	63	-2	1
1883+50.280	65	1866+66.290	63	2	1
1866+66.290	63	1852+14.359	62	2	1
1852+14.359	62	1819+02.306	57	4	1
1819+02.306	57	1793+95.145	65	-7	1
1782+49.322	65	1763+99.822	64	1	1
1763+99.822	64	1749+60.945	63	1	1
1749+60.945	63	1729+24.812	59	5	1
1708+78.251	64	1704+03.820	63	1	1
1704+03.820	63	1688+79.987	63	0	1
1676+73.409	64	1675+12.295	63	0	1
1662+28.337	64	1652+11.160	63	1	1
1629+77.568	65	1621+46.738	64	1	1
1621+46.738	64	1600+40.495	57	6	2
1578+08.107	59	1570+18.580	57	2	1
1570+18.580	57	1548+64.398	63	-6	1
1521+80.485	64	1518+44.144	63	0	1
1518+44.144	63	1505+09.701	62	2	1
1480+02.758	63	1478+43.352	63	0	1
1465+04.150	64	1461+98.062	64	0	1
1450+11.675	65	1439+70.699	62	2	1
1427+49.739	63	1421+34.750	62	1	1
1402+36.769	65	1375+23.561	63	2	1
1375+23.561	63	1355+75.006	60	3	1
1355+75.006	60	1345+88.891	63	-3	1

**Speed Differential of Adjacent Design Elements Check Conditions Key**Condition 1:  $0 \text{ mph} (V_{85_{\text{Tangent}}} - V_{85_{\text{Curve}}}) \leq 6 \text{ mph}$ Condition 2:  $6 \text{ mph} < (V_{85_{\text{Tangent}}} - V_{85_{\text{Curve}}}) \leq 12 \text{ mph}$

Condition 3:  $12 \text{ mph} < (V_{85_{\text{Tangent}}} - V_{85_{\text{Curve}}})$

where:

$V_{85_{\text{Tangent}}}$ : estimated 85th percentile operating speed on tangent

$V_{85_{\text{Curve}}}$ : estimated 85th percentile operating speed at the beginning of the curve

*Interactive Highway Safety Design Model*

**Design Consistency Evaluation Report**

**P2\_6 Alignment Alternative**

January 5, 2018



## **Disclaimer**

The Interactive Highway Design Model (IHSDM) software is disseminated under the sponsorship of the Department of Transportation in the interest of information exchange. The United States Government assumes no liability for its content or use thereof. This document does not constitute a standard, specification, or regulation.

The United States Government does not endorse products or manufacturers. Trade and manufacturers' names may appear in this software and documentation only because they are considered essential to the objective of the software.

## **Limited Warranty and Limitations of Remedies**

This software product is provided "as-is," without warranty of any kind-either expressed or implied (but not limited to the implied warranties of merchantability and fitness for a particular purpose). The FHWA do not warrant that the functions contained in the software will meet the end-user's requirements or that the operation of the software will be uninterrupted and error-free.

Under no circumstances will the FHWA be liable to the end-user for any damages or claimed lost profits, lost savings, or other incidental or consequential damages rising out of the use or inability to use the software (even if these organizations have been advised of the possibility of such damages), or for any claim by any other party.

## **Notice**

The use of the IHSDM software is being done strictly on a voluntary basis. In exchange for provision of IHSDM, the user agrees that the Federal Highway Administration (FHWA), U.S. Department of Transportation and any other agency of the Federal Government shall not be responsible for any errors, damage or other liability that may result from any and all use of the software, including installation and testing of the software. The user further agrees to hold the FHWA and the Federal Government harmless from any resulting liability. The user agrees that this hold harmless provision shall flow to any person to whom or any entity to which the user provides the IHSDM software. It is the user's full responsibility to inform any person to whom or any entity to which it provides the IHSDM software of this hold harmless provision.



## Table of Contents

<b>Report Overview</b> .....	<b>1</b>
<b>Design Consistency Results, Increasing Stations</b> .....	<b>3</b>
<b>Design Consistency Results, Decreasing Stations</b> .....	<b>9</b>

## List of Tables

Table V85 Speed Profile Coordinates, Increasing Stations .....	4
Table Design Speed Assumption, Increasing Stations .....	6
Table Speed Differential of Adjacent Design Elements, Increasing Stations .....	7
Table V85 Speed Profile Coordinates, Decreasing Stations .....	10
Table Design Speed Assumption, Decreasing Stations .....	12
Table Speed Differential of Adjacent Design Elements, Decreasing Stations .....	13

## List of Figures

Figure Graphical Results, Increasing Stations .....	3
Figure Graphical Results, Decreasing Stations .....	9

## Report Overview

**Report Generated:** Jan 5, 2018 1:29 PM

**Report Template:** System: Multi-Page, by Travel Direction [System] (dcm4, Oct 9, 2017 1:45 PM)

**Evaluation Date:** Fri Jan 05 13:28:30 AKST 2018

**IHSDM Version:** v13.0.0 (Sep 13, 2017)

**Design Consistency Module:** v4.0.0 (Sep 23, 2016)

**User Name:** RaeAnne Hebnes

**Organization Name:** Michael Baker International

**Phone:**

**E-Mail:**

**Project Title:** Parks 305 - 325 v2

**Project Comment:** Created using wizard

**Project Unit System:** U.S. Customary

**Highway Title:** Alignment P2\_6\_1dec2017

**Highway Comment:** Alignment P2\_1dec2017 with 6% max grade

**Highway Version:** 1

**Evaluation Title:** Evaluation 16

**Evaluation Comment:** Created Fri Jan 05 13:28:26 AKST 2018

**Minimum Station:** 0.000

**Maximum Station:** 2424+38.143(1)

**Design vs. Operating Speed:** true

**Predicted Speed Differential of Adjacent Elements:** true

**Specify Start/Ends Speeds:** false

**Speed at Evaluation Start (Increasing):** 62 mph

**Speed at Evaluation End (Increasing):** 62 mph

**Speed at Evaluation Start (Decreasing):** 62 mph

**Speed at Evaluation End (Decreasing):** 62 mph

### Run Time Messages

Base speed calculations from 0.000 to 2424+38.143(1) with high speed model

Predicted 72 speeds

Adjusting 72 speeds for acceleration/deceleration

Testing 106 adjusted speeds for grade limiting.

A total of 0 speeds added or modified due to grade limiting.

Base speed calculations from 2424+38.143(1) to 0.000 with high speed model

Predicted 72 speeds

Adjusting 72 speeds for acceleration/deceleration

Testing 107 adjusted speeds for grade limiting.

A total of 0 speeds added or modified due to grade limiting.

# Design Consistency Results, Increasing Stations

Figure 1 below displays the graphical results of the Design Consistency Module evaluation for travel the direction of increasing stations.

[Graphical Output in the DCM Engineer's Manual]

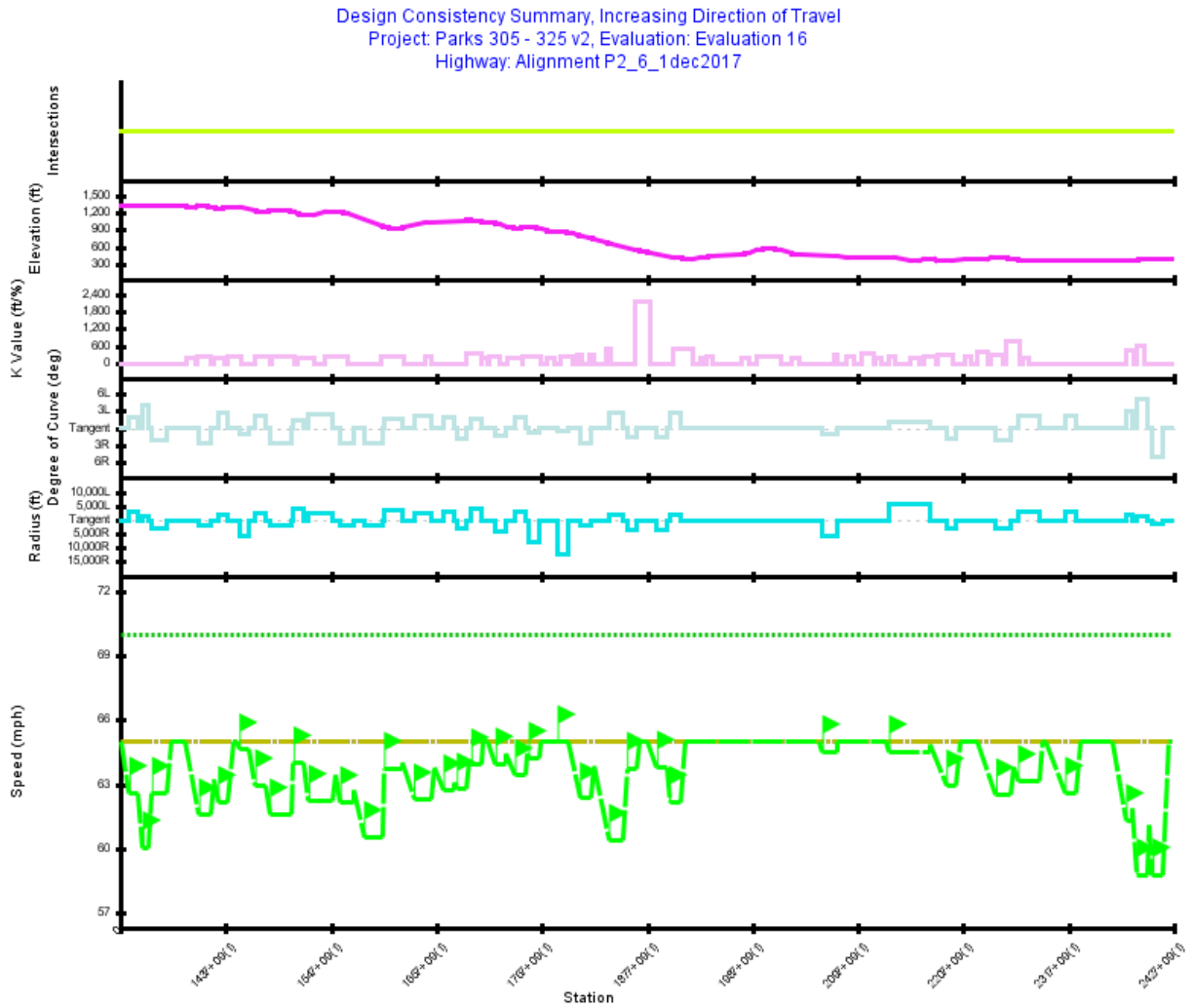

NOTE: Speed profile does NOT account for intersections.

- |  |   |
|--|---|
| <ul style="list-style-type: none"> <li>Legend</li> <li>Intersections</li> <li>Vertical Alignment (Elevation); ft</li> <li>Vertical Alignment Curvature K Value; ft/%</li> <li>Horizontal Alignment Degree of Curve; deg</li> <li>Horizontal Alignment Radius; ft</li> <li>Posted Speed; mph</li> </ul> | <ul style="list-style-type: none"> <li>Desired Speed; mph</li> <li>Design Speed; mph</li> <li>V85 Speed; mph</li> <li>design element differential &lt; 6 MPH</li> </ul> |
|--|---|

**Figure 1. Graphical Results, Increasing Stations**

## V85 Speed Profile

Table 1 displays the tabular results of the V85 speed profile evaluation for travel in the direction of increasing stations.

[[V85 Speed Profile in the DCM Engineer's Manual](#)]

**Table 1. V85 Speed Profile Coordinates, Increasing Stations**

Station	Segment Type	V85 Speed (mph)	Speed Model
0.000	Non-Curve	65	High Speed
1336+44.302(1)	Curve	63	High Speed
1345+88.891(1)	Non-Curve	63	High Speed
1350+43.605(1)	Curve	60	High Speed
1355+75.006(1)	Non-Curve	60	High Speed
1359+98.149(1)	Curve	63	High Speed
1375+23.561(1)	Non-Curve	63	High Speed
1380+03.884(1)	Non-Curve	65	High Speed
1394+18.059(1)	Non-Curve	65	High Speed
1409+13.059(1)	Curve	62	High Speed
1421+34.750(1)	Non-Curve	62	High Speed
1424+55.645(1)	Non-Curve	63	High Speed
1429+14.713(1)	Curve	62	High Speed
1439+70.699(1)	Non-Curve	62	High Speed
1445+33.762(1)	Non-Curve	65	High Speed
1448+04.555(1)	Non-Curve	65	High Speed
1451+33.375(1)	Curve	65	High Speed
1461+98.062(1)	Non-Curve	65	High Speed
1467+73.811(1)	Curve	63	High Speed
1478+43.352(1)	Non-Curve	63	High Speed
1483+12.985(1)	Curve	62	High Speed
1505+09.701(1)	Non-Curve	62	High Speed
1507+88.933(1)	Curve	64	High Speed
1518+44.144(1)	Non-Curve	64	High Speed
1523+64.397(1)	Curve	62	High Speed
1548+64.398(1)	Non-Curve	62	High Speed
1551+06.010(1)	Non-Curve	63	High Speed
1556+63.827(1)	Curve	62	High Speed
1570+18.580(1)	Non-Curve	62	High Speed
1571+23.710(1)	Non-Curve	63	High Speed
1581+42.155(1)	Curve	61	High Speed
1600+40.495(1)	Non-Curve	61	High Speed
1602+30.336(1)	Curve	64	High Speed
1621+46.738(1)	Non-Curve	64	High Speed
1621+91.876(1)	Non-Curve	64	High Speed
1633+46.402(1)	Curve	62	High Speed
1652+11.160(1)	Non-Curve	62	High Speed
1655+14.362(1)	Non-Curve	64	High Speed
1664+36.565(1)	Curve	63	High Speed
1675+12.295(1)	Non-Curve	63	High Speed
1675+83.893(1)	Non-Curve	63	High Speed
1678+20.135(1)	Curve	63	High Speed
1688+79.987(1)	Non-Curve	63	High Speed

Station	Segment Type	V85 Speed (mph)	Speed Model
1691+49.503(1)	Non-Curve	64	High Speed
1693+40.960(1)	Curve	64	High Speed
1704+03.820(1)	Non-Curve	64	High Speed
1706+22.440(1)	Non-Curve	65	High Speed
1709+95.746(1)	Non-Curve	65	High Speed
1718+73.301(1)	Curve	64	High Speed
1729+24.812(1)	Non-Curve	64	High Speed
1730+22.287(1)	Non-Curve	64	High Speed
1738+90.122(1)	Curve	63	High Speed
1749+60.945(1)	Non-Curve	63	High Speed
1751+63.459(1)	Non-Curve	64	High Speed
1753+37.825(1)	Curve	64	High Speed
1763+99.822(1)	Non-Curve	64	High Speed
1765+56.917(1)	Non-Curve	65	High Speed
1783+38.648(1)	Curve	65	High Speed
1793+95.145(1)	Non-Curve	65	High Speed
1806+82.524(1)	Curve	62	High Speed
1819+02.306(1)	Non-Curve	62	High Speed
1822+08.475(1)	Non-Curve	64	High Speed
1837+12.472(1)	Curve	60	High Speed
1852+14.359(1)	Non-Curve	60	High Speed
1855+90.269(1)	Curve	64	High Speed
1866+66.290(1)	Non-Curve	64	High Speed
1869+17.117(1)	Non-Curve	65	High Speed
1877+11.899(1)	Non-Curve	65	High Speed
1887+17.885(1)	Curve	64	High Speed
1897+69.447(1)	Non-Curve	64	High Speed
1900+15.731(1)	Curve	62	High Speed
1911+44.501(1)	Non-Curve	62	High Speed
1917+07.564(1)	Non-Curve	65	High Speed
2055+94.436(1)	Non-Curve	65	High Speed
2059+91.129(1)	Curve	65	High Speed
2075+32.995(1)	Non-Curve	65	High Speed
2076+27.446(1)	Non-Curve	65	High Speed
2125+52.843(1)	Non-Curve	65	High Speed
2129+49.536(1)	Curve	65	High Speed
2172+19.006(1)	Non-Curve	65	High Speed
2172+90.318(1)	Non-Curve	65	High Speed
2189+34.430(1)	Curve	63	High Speed
2200+10.193(1)	Non-Curve	63	High Speed
2204+24.787(1)	Non-Curve	65	High Speed
2220+94.337(1)	Non-Curve	65	High Speed
2241+30.583(1)	Curve	63	High Speed
2256+59.979(1)	Non-Curve	63	High Speed
2259+04.445(1)	Non-Curve	64	High Speed
2264+09.452(1)	Curve	63	High Speed
2286+77.767(1)	Non-Curve	63	High Speed
2290+49.666(1)	Non-Curve	65	High Speed
2292+47.205(1)	Non-Curve	65	High Speed
2313+38.578(1)	Curve	63	High Speed
2324+89.129(1)	Non-Curve	63	High Speed
2329+69.574(1)	Non-Curve	65	High Speed

Station	Segment Type	V85 Speed (mph)	Speed Model
2363+01.360(1)	Non-Curve	65	High Speed
2376+93.270(1)	Curve	61	High Speed
2382+89.464(1)	Non-Curve	61	High Speed
2383+98.195(1)	Non-Curve	62	High Speed
2388+00.142(1)	Curve	59	High Speed
2399+47.886(1)	Non-Curve	59	High Speed
2401+60.528(1)	Non-Curve	61	High Speed
2404+59.393(1)	Curve	59	High Speed
2415+33.737(1)	Non-Curve	59	High Speed
2421+21.346(1)	Non-Curve	65	High Speed
2424+38.143(1)	Non-Curve	65	High Speed

## Design Speed Assumption

Table 2 displays the tabular results of the design speed assumption evaluation for travel in the direction of increasing stations.

[[Design Speed Assumption Check in the DCM Engineer's Manual](#)]

**Table 2. Design Speed Assumption, Increasing Stations**

From Station	To Station	Min (mph)	Max (mph)	Condition
0.000	2424+38.143(1)	-11	-5	4

### Design Speed Assumption Check Conditions Key

Condition 1:  $0 \text{ mph} \leq (V_{85} - V_{\text{design}}) \leq 6 \text{ mph}$

Condition 2:  $6 \text{ mph} < (V_{85} - V_{\text{design}}) \leq 12 \text{ mph}$

Condition 3:  $12 \text{ mph} < (V_{85} - V_{\text{design}})$

Condition 4:  $(V_{85} - V_{\text{design}}) < 0 \text{ mph}$

where:

$V_{85}$ : estimated 85th percentile operating speed

$V_{\text{design}}$ : design speed

## Speed Differential of Adjacent Design Elements

Table 3 displays the tabular results of the speed differential of adjacent design elements evaluation for travel in the direction of increasing stations.

[Speed Differential of Adjacent Design Elements Check in the DCM Engineer's Manual]

**Table 3. Speed Differential of Adjacent Design Elements, Increasing Stations**

Station of Max Speed on Preceding Element	Max Speed on Preceding Element (mph)	Start of Curve	Speed on Curve (mph)	Speed Differential (mph)	Condition
0.000	65	1336+44.302(1)	63	2	1
1336+44.302(1)	63	1350+43.605(1)	60	3	1
1350+43.605(1)	60	1359+98.149(1)	63	-3	1
1380+03.884(1)	65	1409+13.059(1)	62	3	1
1424+55.645(1)	63	1429+14.713(1)	62	1	1
1445+33.762(1)	65	1451+33.375(1)	65	0	1
1451+33.375(1)	65	1467+73.811(1)	63	2	1
1467+73.811(1)	63	1483+12.985(1)	62	1	1
1483+12.985(1)	62	1507+88.933(1)	64	-2	1
1507+88.933(1)	64	1523+64.397(1)	62	2	1
1551+06.010(1)	63	1556+63.827(1)	62	1	1
1571+23.710(1)	63	1581+42.155(1)	61	2	1
1581+42.155(1)	61	1602+30.336(1)	64	-3	1
1621+91.876(1)	64	1633+46.402(1)	62	2	1
1655+14.362(1)	64	1664+36.565(1)	63	1	1
1675+83.893(1)	63	1678+20.135(1)	63	0	1
1691+49.503(1)	64	1693+40.960(1)	64	0	1
1706+22.440(1)	65	1718+73.301(1)	64	1	1
1730+22.287(1)	64	1738+90.122(1)	63	1	1
1751+63.459(1)	64	1753+37.825(1)	64	0	1
1765+56.917(1)	65	1783+38.648(1)	65	0	1
1783+38.648(1)	65	1806+82.524(1)	62	3	1
1822+08.475(1)	64	1837+12.472(1)	60	4	1
1837+12.472(1)	60	1855+90.269(1)	64	-3	1
1869+17.117(1)	65	1887+17.885(1)	64	1	1
1887+17.885(1)	64	1900+15.731(1)	62	2	1
1917+07.564(1)	65	2059+91.129(1)	65	0	1
2076+27.446(1)	65	2129+49.536(1)	65	0	1
2172+90.318(1)	65	2189+34.430(1)	63	2	1
2204+24.787(1)	65	2241+30.583(1)	63	2	1
2259+04.445(1)	64	2264+09.452(1)	63	1	1
2290+49.666(1)	65	2313+38.578(1)	63	2	1
2329+69.574(1)	65	2376+93.270(1)	61	4	1
2383+98.195(1)	62	2388+00.142(1)	59	3	1
2401+60.528(1)	61	2404+59.393(1)	59	2	1



**Speed Differential of Adjacent Design Elements Check Conditions Key**

Condition 1:  $0 \text{ mph} < (V_{85_{\text{Tangent}}} - V_{85_{\text{Curve}}}) \leq 6 \text{ mph}$

Condition 2:  $6 \text{ mph} < (V_{85_{\text{Tangent}}} - V_{85_{\text{Curve}}}) \leq 12 \text{ mph}$

Condition 3:  $12 \text{ mph} < (V_{85_{\text{Tangent}}} - V_{85_{\text{Curve}}})$

where:

$V_{85_{\text{Tangent}}}$ : estimated 85th percentile operating speed on tangent

$V_{85_{\text{Curve}}}$ : estimated 85th percentile operating speed at the beginning of the curve

## Design Consistency Results, Decreasing Stations

Figure 2 below displays the graphical results of the Design Consistency Module evaluation for travel the direction of decreasing stations.

[Graphical Output in the DCM Engineer's Manual]

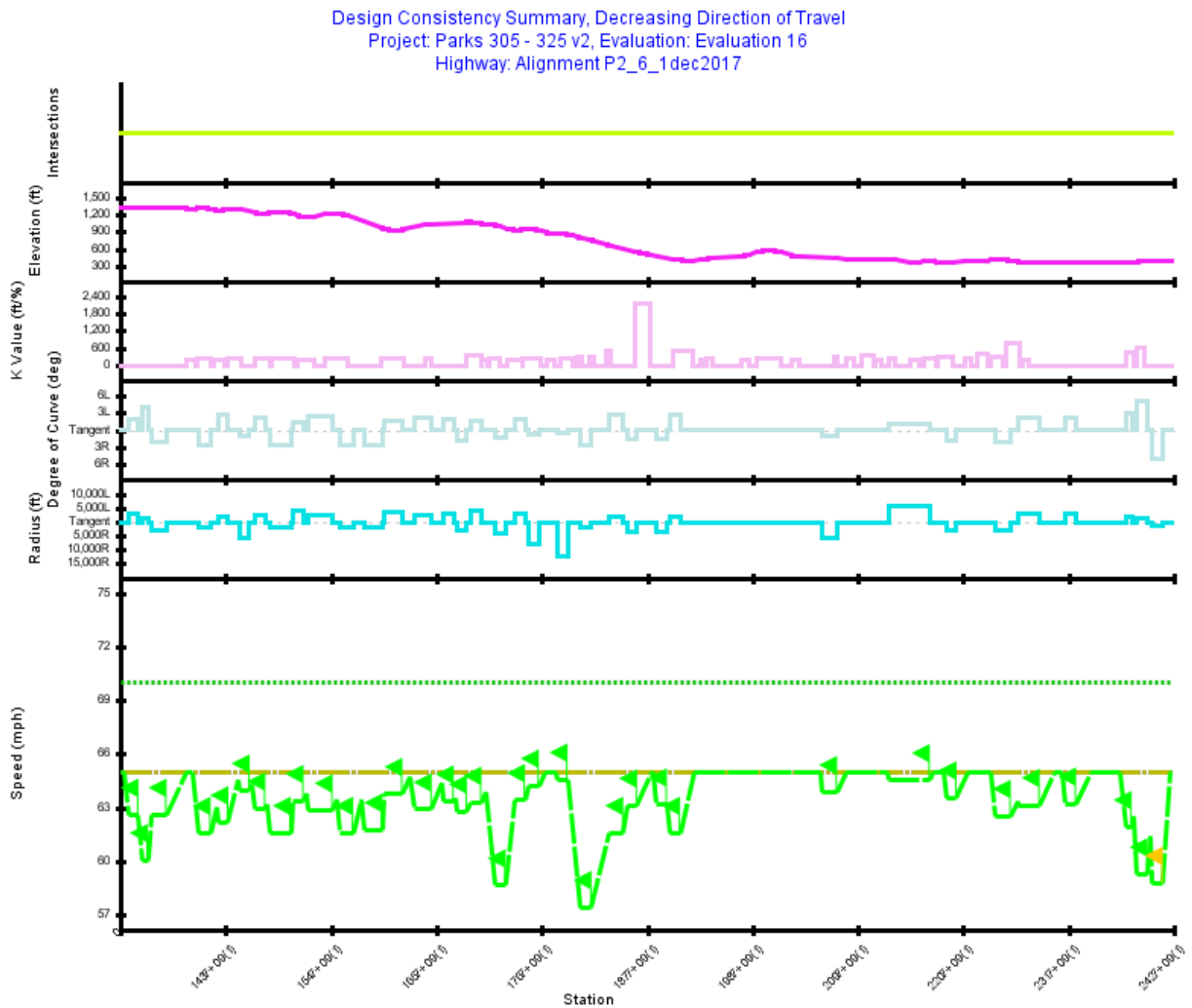

NOTE: Speed profile does NOT account for intersections.

- Legend
- Intersections
  - Vertical Alignment (Elevation); ft
  - Vertical Alignment Curvature K Value; ft/%
  - Horizontal Alignment Degree of Curve; deg
  - Horizontal Alignment Radius; ft
  - Posted Speed; mph
  - Desired Speed; mph
  - Design Speed; mph
  - V85 Speed; mph
  - design element differential < 6 MPH
  - design element differential <= 12 MPH

Figure 2. Graphical Results, Decreasing Stations

### V85 Speed Profile

Table 4 displays the tabular results of the V85 speed profile evaluation for travel in the direction of decreasing stations.

[[V85 Speed Profile in the DCM Engineer's Manual](#)]

**Table 4. V85 Speed Profile Coordinates, Decreasing Stations**

Station	Segment Type	V85 Speed (mph)	Speed Model
2424+38.143(1)	Non-Curve	65	High Speed
2423+59.594(1)	Non-Curve	65	High Speed
2415+33.737(1)	Curve	59	High Speed
2404+59.393(1)	Non-Curve	59	High Speed
2402+21.515(1)	Non-Curve	61	High Speed
2399+47.886(1)	Curve	59	High Speed
2388+00.142(1)	Non-Curve	59	High Speed
2385+02.117(1)	Non-Curve	62	High Speed
2382+89.464(1)	Curve	62	High Speed
2376+93.270(1)	Non-Curve	62	High Speed
2370+77.781(1)	Non-Curve	65	High Speed
2340+46.706(1)	Non-Curve	65	High Speed
2324+89.129(1)	Curve	63	High Speed
2313+38.578(1)	Non-Curve	63	High Speed
2309+80.761(1)	Non-Curve	65	High Speed
2302+11.094(1)	Non-Curve	65	High Speed
2286+77.767(1)	Curve	63	High Speed
2264+09.452(1)	Non-Curve	63	High Speed
2263+61.325(1)	Non-Curve	63	High Speed
2256+59.979(1)	Curve	63	High Speed
2241+30.583(1)	Non-Curve	63	High Speed
2236+36.705(1)	Non-Curve	65	High Speed
2212+23.092(1)	Non-Curve	65	High Speed
2200+10.193(1)	Curve	64	High Speed
2189+34.430(1)	Non-Curve	64	High Speed
2186+45.645(1)	Non-Curve	65	High Speed
2176+15.699(1)	Non-Curve	65	High Speed
2172+19.006(1)	Curve	65	High Speed
2129+49.536(1)	Non-Curve	65	High Speed
2128+55.085(1)	Non-Curve	65	High Speed
2084+95.912(1)	Non-Curve	65	High Speed
2075+32.995(1)	Curve	64	High Speed
2059+91.129(1)	Non-Curve	64	High Speed
2057+61.863(1)	Non-Curve	65	High Speed
1926+39.501(1)	Non-Curve	65	High Speed
1911+44.501(1)	Curve	62	High Speed
1900+15.731(1)	Non-Curve	62	High Speed
1897+69.447(1)	Curve	63	High Speed
1887+17.885(1)	Non-Curve	63	High Speed
1883+50.280(1)	Non-Curve	65	High Speed
1882+55.524(1)	Non-Curve	65	High Speed
1866+66.290(1)	Curve	63	High Speed
1855+90.269(1)	Non-Curve	63	High Speed

Station	Segment Type	V85 Speed (mph)	Speed Model
1852+14.359(1)	Curve	62	High Speed
1837+12.472(1)	Non-Curve	62	High Speed
1819+02.306(1)	Curve	57	High Speed
1806+82.524(1)	Non-Curve	57	High Speed
1793+95.145(1)	Curve	65	High Speed
1783+38.648(1)	Non-Curve	65	High Speed
1782+49.322(1)	Non-Curve	65	High Speed
1770+59.622(1)	Non-Curve	65	High Speed
1763+99.822(1)	Curve	64	High Speed
1753+37.825(1)	Non-Curve	64	High Speed
1749+60.945(1)	Curve	63	High Speed
1738+90.122(1)	Non-Curve	63	High Speed
1729+24.812(1)	Curve	59	High Speed
1718+73.301(1)	Non-Curve	59	High Speed
1708+78.251(1)	Non-Curve	64	High Speed
1704+03.820(1)	Curve	63	High Speed
1693+40.960(1)	Non-Curve	63	High Speed
1688+79.987(1)	Curve	63	High Speed
1678+20.135(1)	Non-Curve	63	High Speed
1676+73.409(1)	Non-Curve	64	High Speed
1675+12.295(1)	Curve	63	High Speed
1664+36.565(1)	Non-Curve	63	High Speed
1662+28.337(1)	Non-Curve	64	High Speed
1652+11.160(1)	Curve	63	High Speed
1633+46.402(1)	Non-Curve	63	High Speed
1629+77.568(1)	Non-Curve	65	High Speed
1621+46.738(1)	Curve	64	High Speed
1602+30.336(1)	Non-Curve	64	High Speed
1600+40.495(1)	Curve	62	High Speed
1581+42.155(1)	Non-Curve	62	High Speed
1578+14.694(1)	Non-Curve	63	High Speed
1570+18.580(1)	Curve	62	High Speed
1556+63.827(1)	Non-Curve	62	High Speed
1552+90.879(1)	Non-Curve	63	High Speed
1548+64.398(1)	Curve	63	High Speed
1523+64.397(1)	Non-Curve	63	High Speed
1521+80.485(1)	Non-Curve	64	High Speed
1518+44.144(1)	Curve	63	High Speed
1507+88.933(1)	Non-Curve	63	High Speed
1505+09.701(1)	Curve	62	High Speed
1483+12.985(1)	Non-Curve	62	High Speed
1480+02.758(1)	Non-Curve	63	High Speed
1478+43.352(1)	Curve	63	High Speed
1467+73.811(1)	Non-Curve	63	High Speed
1465+04.150(1)	Non-Curve	64	High Speed
1461+98.062(1)	Curve	64	High Speed
1451+33.375(1)	Non-Curve	64	High Speed
1450+11.675(1)	Non-Curve	65	High Speed
1439+70.699(1)	Curve	62	High Speed
1429+14.713(1)	Non-Curve	62	High Speed
1427+49.739(1)	Non-Curve	63	High Speed
1421+34.750(1)	Curve	62	High Speed

Station	Segment Type	V85 Speed (mph)	Speed Model
1409+13.059(1)	Non-Curve	62	High Speed
1402+36.769(1)	Non-Curve	65	High Speed
1395+40.919(1)	Non-Curve	65	High Speed
1375+23.561(1)	Curve	63	High Speed
1359+98.149(1)	Non-Curve	63	High Speed
1355+75.006(1)	Curve	60	High Speed
1350+43.605(1)	Non-Curve	60	High Speed
1345+88.891(1)	Curve	63	High Speed
1336+44.302(1)	Non-Curve	63	High Speed
1331+63.979(1)	Non-Curve	65	High Speed
0.000	Non-Curve	65	High Speed

## Design Speed Assumption

Table 5 displays the tabular results of the design speed assumption evaluation for travel in the direction of decreasing stations.

[[Design Speed Assumption Check in the DCM Engineer's Manual](#)]

**Table 5. Design Speed Assumption, Decreasing Stations**

From Station	To Station	Min (mph)	Max (mph)	Condition
2424+38.143(1)	0.000	-13	-5	4

### Design Speed Assumption Check Conditions Key

Condition 1:  $0 \text{ mph} \leq (V_{85} - V_{\text{design}}) \leq 6 \text{ mph}$

Condition 2:  $6 \text{ mph} < (V_{85} - V_{\text{design}}) \leq 12 \text{ mph}$

Condition 3:  $12 \text{ mph} < (V_{85} - V_{\text{design}})$

Condition 4:  $(V_{85} - V_{\text{design}}) < 0 \text{ mph}$

where:

$V_{85}$ : estimated 85th percentile operating speed

$V_{\text{design}}$ : design speed

## Speed Differential of Adjacent Design Elements

Table 6 displays the tabular results of the speed differential of adjacent design elements evaluation for travel in the direction of decreasing stations.

[Speed Differential of Adjacent Design Elements Check in the DCM Engineer's Manual]

**Table 6. Speed Differential of Adjacent Design Elements, Decreasing Stations**

Station of Max Speed on Preceding Element	Max Speed on Preceding Element (mph)	Start of Curve	Speed on Curve (mph)	Speed Differential (mph)	Condition
2424+38.143(1)	65	2415+33.737(1)	59	6	2
2402+21.515(1)	61	2399+47.886(1)	59	2	1
2385+02.117(1)	62	2382+89.464(1)	62	1	1
2370+77.781(1)	65	2324+89.129(1)	63	2	1
2309+80.761(1)	65	2286+77.767(1)	63	2	1
2263+61.325(1)	63	2256+59.979(1)	63	1	1
2236+36.705(1)	65	2200+10.193(1)	64	1	1
2186+45.645(1)	65	2172+19.006(1)	65	0	1
2128+55.085(1)	65	2075+32.995(1)	64	1	1
2057+61.863(1)	65	1911+44.501(1)	62	3	1
1911+44.501(1)	62	1897+69.447(1)	63	-2	1
1883+50.280(1)	65	1866+66.290(1)	63	2	1
1866+66.290(1)	63	1852+14.359(1)	62	2	1
1852+14.359(1)	62	1819+02.306(1)	57	4	1
1819+02.306(1)	57	1793+95.145(1)	65	-7	1
1782+49.322(1)	65	1763+99.822(1)	64	1	1
1763+99.822(1)	64	1749+60.945(1)	63	1	1
1749+60.945(1)	63	1729+24.812(1)	59	5	1
1708+78.251(1)	64	1704+03.820(1)	63	1	1
1704+03.820(1)	63	1688+79.987(1)	63	0	1
1676+73.409(1)	64	1675+12.295(1)	63	0	1
1662+28.337(1)	64	1652+11.160(1)	63	1	1
1629+77.568(1)	65	1621+46.738(1)	64	1	1
1621+46.738(1)	64	1600+40.495(1)	62	2	1
1578+14.694(1)	63	1570+18.580(1)	62	2	1
1552+90.879(1)	63	1548+64.398(1)	63	1	1
1521+80.485(1)	64	1518+44.144(1)	63	0	1
1518+44.144(1)	63	1505+09.701(1)	62	2	1
1480+02.758(1)	63	1478+43.352(1)	63	0	1
1465+04.150(1)	64	1461+98.062(1)	64	0	1
1450+11.675(1)	65	1439+70.699(1)	62	2	1
1427+49.739(1)	63	1421+34.750(1)	62	1	1
1402+36.769(1)	65	1375+23.561(1)	63	2	1
1375+23.561(1)	63	1355+75.006(1)	60	3	1
1355+75.006(1)	60	1345+88.891(1)	63	-3	1

**Speed Differential of Adjacent Design Elements Check Conditions Key**

Condition 1:  $0 \text{ mph} < (V_{85_{\text{Tangent}}} - V_{85_{\text{Curve}}}) \leq 6 \text{ mph}$

Condition 2:  $6 \text{ mph} < (V_{85_{\text{Tangent}}} - V_{85_{\text{Curve}}}) \leq 12 \text{ mph}$

Condition 3:  $12 \text{ mph} < (V_{85_{\text{Tangent}}} - V_{85_{\text{Curve}}})$

where:

$V_{85_{\text{Tangent}}}$ : estimated 85th percentile operating speed on tangent

$V_{85_{\text{Curve}}}$ : estimated 85th percentile operating speed at the beginning of the curve

# Preliminary Hydraulic & Hydrologic Report

Parks Highway MP 305-325 Reconstruction  
DOT&PF/Federal Project No. Z606570000/0A45028  
PSA No. 025-5-1-048



Prepared for:



Northern Region  
Alaska Department of  
Transportation and  
Public Facilities  
2301 Peger Road  
Fairbanks, AK 99709  
907.451.2210

Prepared by:

**Michael Baker International**

3900 C Street, Suite 900  
Anchorage, AK 99503  
907.273.1600

5/18/2016



## Revision History

Revision	Date	Description
Draft	3/28/2016	Issued for Review
Final	5/19/2016	Final Preliminary Report

## EXECUTIVE SUMMARY

---

The Northern Region State of Alaska Department of Transportation and Public Facilities (DOT&PF, also referred to as the Department) is reconstructing the Parks Highway from the Tanana River Bridge at Nenana (milepost [MP] 305) to the Fairbanks North Star Borough boundary (MP 325). The purpose of this project is to upgrade the Parks Highway to eliminate load restrictions, enhance safety, and enhance commercial and recreational function of this highway route. The project includes drainage improvements for existing culverts, the addition of culverts, and replacement of Little Goldstream Creek Bridge No. 678.

This report presents the preliminary hydraulic and hydrologic (H&H) analyses performed to evaluate existing conditions and provide recommendations for proposed design. The analyses focus on the existing highway drainage system including two inlets, 74 culverts and one bridge, Little Goldstream Creek Bridge No. 678, and proposed drainage improvements along the entire project corridor.

Survey data of Little Goldstream Creek Bridge, Little Goldstream Creek, culverts, and storm drain catch basins within the project corridor were collected by Design Alaska, Inc. in the fall of 2015. Field investigation of five streams within the project corridor were completed by Michael Baker International (Michael Baker) in the fall of 2015. This report is based on those data collected in 2015. The H&H analyses and proposed improvements within this report are completed on a preliminary level. Additional H&H analyses, design, and documentation may be required for final design.

Previous H&H analyses (AKDOT&PF, 2006) indicated the existing Little Goldstream Creek Bridge No. 678 would experience pressure/weir flow at the 1% and 0.2% annual chance exceedance interval peak streamflow conditions. Current analysis with revised regression equations for peak streamflow prediction indicate the bridge will pass with 1% and 0.2% flows freely. The proposed bridge will include a single span of 120 feet (ft). The water surface elevation of the 1% annual chance exceedance storm is expected to be lower than the low chord of the bridge.

To facilitate improved drainage along the project corridor, several 24-inch (in) culverts are recommended for replacement with 36-in culverts. The larger diameter culverts have the potential to reduce sedimentation, ice buildup, and debris accumulation within the culvert barrel and therefore provide better conveyance. Drainage ditches adjacent to culverts may also require regrading (based on final design) to improve conveyance at the culvert inlets. Sediment basins may be included in the design for intercepting fine sediments upstream of the culvert inlets. Hydraulic analysis of the 3.2-ft high (H) by 4.7-ft wide (W) corrugated metal pipe (CMP) culvert indicates that design criteria are met but the road might be overtopped for a 500-year flood event. A detailed analysis is recommended to evaluate if the existing culvert should be replaced by either a larger circular, two circular, box, or arch culvert. The existing 48-in CMP culvert meets all design criteria and road overtopping is not a concern. Two new 48-in CMP culverts, are proposed to be installed at MP 310.4 and MP 312.1 to improve drainage.

**TABLE OF CONTENTS**

Executive Summary .....	ii
Acronyms and Abbreviations.....	vi
1. Introduction .....	1
1.1 Background Data.....	3
2. Site Description.....	3
3. Existing Drainage Structures .....	3
3.1 Inlets and Culverts.....	3
3.2 Little Goldstream Creek Bridge .....	9
4. Hydrology 11	
4.1 Project Corridor Watershed .....	11
4.2 Existing Major Culverts.....	14
Watershed .....	14
Flood Frequency .....	14
Fish Passage .....	15
Peak Discharge.....	15
4.3 Little Goldstream Creek Bridge .....	15
Watershed .....	15
Flood Frequency .....	15
Fish Passage .....	16
Peak Discharge.....	16
5. Hydraulics 16	
5.1 Culverts .....	16
Overtopping Flood .....	23
5.2 Little Goldstream Creek Bridge .....	23
Hydraulic History .....	23
5.2.2 Backwater.....	25
Hydraulic Design .....	25
Scour 27	
Overtopping Flood.....	31
Rip Rap 31	
23 Code of Federal Regulations .....	31
Flood Hazard Area .....	31
6. References .....	32
Appendix A. Little Goldstream Creek Bridge No. 678 As-Builts .....	A-1
Appendix B. HEC-RAS Output Data for Little Goldstream Creek Bridge No. 678.....	B-1

**TABLES**

Table 3-1	Project Corridor Major Culverts.....	8
Table 4-1	Parks Highway Project Corridor NHD Streams.....	14
Table 4-2	Major Culvert Watershed Characteristics.....	14
Table 4-3	Major Culvert Peak Streamflow (cfs) for the Annual Percent Chance Exceedance .....	15
Table 4-4	Little Goldstream Creek Bridge No. 678 Watershed Characteristics .....	15
Table 4-5	Little Goldstream Creek Bridge No. 678 Peak Streamflow (cfs) for the Annual Percent Chance Exceedance .....	15
Table 4-6	Little Goldstream Creek Bridge No. 678 Design Frequency versus Historic Peak Discharge .....	16
Table 5-1	Proposed/Modified Culvert Size and Location .....	22
Table 5-2	HEC-RAS Results for Proposed and Existing Little Goldstream Creek Bridge .....	25
Table 5-3	Little Goldstream Creek Bridge No. 678 Hydraulic Variables .....	27
Table 5-4	Little Goldstream Creek Bridge No. 678 Computed Scour Depth (ft).....	27
Table 5-5	Little Goldstream Creek Bridge No. 678 Contraction-Scour Hydraulic Variables .....	28
Table 5-6	Little Goldstream Creek Bridge No. 678 Pier-Scour Hydraulic Variables.....	28
Table 5-7	Little Goldstream Creek Bridge No. 678 Pressure-Scour Hydraulic Variables .....	28
Table 5-8	Proposed Little Goldstream Creek Bridge No. 678 Hydraulic Variables .....	28
Table 5-9	Proposed Little Goldstream Creek Bridge No. 678 Computed Scour Depth (ft) using a 70- ft Long Bridge Deck .....	29
Table 5-10	Proposed Little Goldstream Creek Bridge No. 678 Computed Scour Depth (ft) using a 90- ft Long Bridge Deck .....	29
Table 5-11	Proposed Little Goldstream Creek Bridge No. 678 Computed Scour Depth (ft) using a 120- ft Long Bridge Deck .....	29
Table 5-12	Proposed Little Goldstream Creek Bridge No. 678 Contraction-Scour Hydraulic Variables .....	29
Table 5-13	Proposed Little Goldstream Creek Bridge No. 678 Abutment-Scour Hydraulic Variables using a 70-ft Long Bridge Deck for a 100-Year Flood Event.....	29
Table 5-14	Proposed Little Goldstream Creek Bridge No. 678 Abutment-Scour Hydraulic Variables using a 70-ft Long Bridge Deck for 100-Year Flood Event .....	30
Table 5-15	Proposed Little Goldstream Creek Bridge No. 678 Abutment-Scour Hydraulic Variables using a 70-ft Long Bridge Deck for a 500-Year Flood Event.....	30
Table 5-16	Proposed Little Goldstream Creek Bridge No. 678 Abutment-Scour Hydraulic Variables using a 70-ft Long Bridge Deck for a 500-Year Flood Event.....	30
Table 5-17	Proposed Little Goldstream Creek Bridge No. 678 Abutment-Scour Hydraulic Variables using a 90-ft Long Bridge Deck for a 500-Year Flood Event.....	30
Table 5-18	Proposed Little Goldstream Creek Bridge No. 678 Abutment-Scour Hydraulic Variables using a 90-ft Long Bridge Deck for a 500-Year Flood Event.....	30

**FIGURES**

---

Figure 1-1 Project Corridor Overview Map ..... 2

Figure 4-1 Parks Highway Project Corridor HUC12 Watersheds..... 13

Figure 5-1 Existing and Proposed Culvert Locations (5 sheets) ..... 17

Figure 5-2 HEC-RAS Little Goldstream Creek Bridge No. 678 Cross Section Locations and Geometry..... 26

**PHOTOS**

---

Photo 3-1 Parks Highway MP 305.4 storm drain catch basin inlet, southbound side of road ..... 4

Photo 3-2 Parks Highway MP 305.4 18-in culvert outlet, southbound side of road ..... 5

Photo 3-3 Parks Highway MP 305.5 18-in culvert outlet, southbound side of road ..... 5

Photo 3-4 Parks Highway MP 311 drainage ditch, looking southeast from northbound side of road ..... 6

Photo 3-5 Parks Highway MP 310.6 3.2-ft H x 4.7-ft W culvert inlet, northbound side of road ..... 6

Photo 3-6 Parks Highway MP 310.6 3.2-ft H x 4.7-ft W culvert outlet, southbound side of road ..... 7

Photo 3-7 Parks Highway MP 312.6 48-in culvert inlet, northbound side of road..... 7

Photo 3-8 Parks Highway MP 312.6 48-in culvert outlet, southbound side of road ..... 8

Photo 3-9 Parks Highway MP 309.6 culvert siltation ..... 9

Photo 3-10 Little Goldstream Creek Bridge No. 678, looking downstream (Northwest)..... 10

Photo 3-11 Little Goldstream Creek Bridge No. 678 North Bridge Abutment ..... 10

Photo 3-12 Little Goldstream Creek Bridge No. 678 South Bridge Abutment ..... 11

Photo 5-1 Little Goldstream Creek debris, looking downstream ..... 24

## ACRONYMS AND ABBREVIATIONS

---

AHDM	Alaska Highway Drainage Manual
ARRC	Alaska Railroad Corporation
BM	Benchmark
cfs	Cubic feet per second
CMP	Corrugated metal pipe
CMPA	Corrugated metal pipe arch
D	Diameter
DOT&PF	Department of Transportation & Public Facilities
Department	DOT&PF Northern Region
ft	feet/foot
H	high/height
H&H	Hydraulic and hydrologic
HUC	Hydrologic Unit Code
HW	Headwater
in	inch
LiDAR	Light Detection and Ranging
mi	Miles
Michael Baker	Michael Baker International
MP	Milepost
NAVD	North American Vertical Datum of 1988
NHD	National Hydrography Dataset
OHW	Ordinary high water
TOB	Top of bank
USGS	U.S. Geological Survey
W	Wide/width
WGS84	World Geodetic System 1984
WSE	Water surface elevation

# 1. INTRODUCTION

---

The Northern Region State of Alaska Department of Transportation and Public Facilities (DOT&PF, also referred to as the Department) is reconstructing the Parks Highway from the Tanana River Bridge at Nenana (milepost [MP] 305) to the Fairbanks North Star Borough boundary (MP 325). The purpose of the project is to upgrade the Parks Highway to eliminate load restrictions, enhance safety, and enhance commercial and recreational function of this highway route. An overview map of the project corridor is shown in Figure 1-1.

As part of the project, Michael Baker International (Michael Baker) is providing preliminary engineering, including this preliminary hydraulic and hydrologic (H&H) report. The purpose of the preliminary H&H report is to:

- Identify and discuss existing and proposed culverts along the entire project corridor
- Propose drainage improvements along the entire project corridor
- Provide design guidance for replacement of Little Goldstream Creek Bridge No. 678

The H&H analyses and proposed improvements within this report are completed on a preliminary level. Additional H&H analyses, design, and documentation will be required prior to final roadway design. The standards used in this preliminary H&H report were selected in accordance with the criteria and procedures given within the following references:

- DOT&PF Alaska Highway Preconstruction Manual
- DOT&PF Alaska Highway Drainage Manual (AHDM)
- DOT&PF Standard Specifications for Highway Construction
- American Association of State Highway and Transportation Officials Highway Drainage Guidelines
- Federal Highway Administration Hydraulic Design Series Number 5
- U.S. Geologic Survey (USGS) Estimating the Magnitude and Frequency of Peak Streamflows for Ungaged Sites on Streams in Alaska and Conterminous Basins in Canada (2003)
- USGS Magnitude and Frequency of Flood in Alaska and Conterminous Basins of Canada (1994)

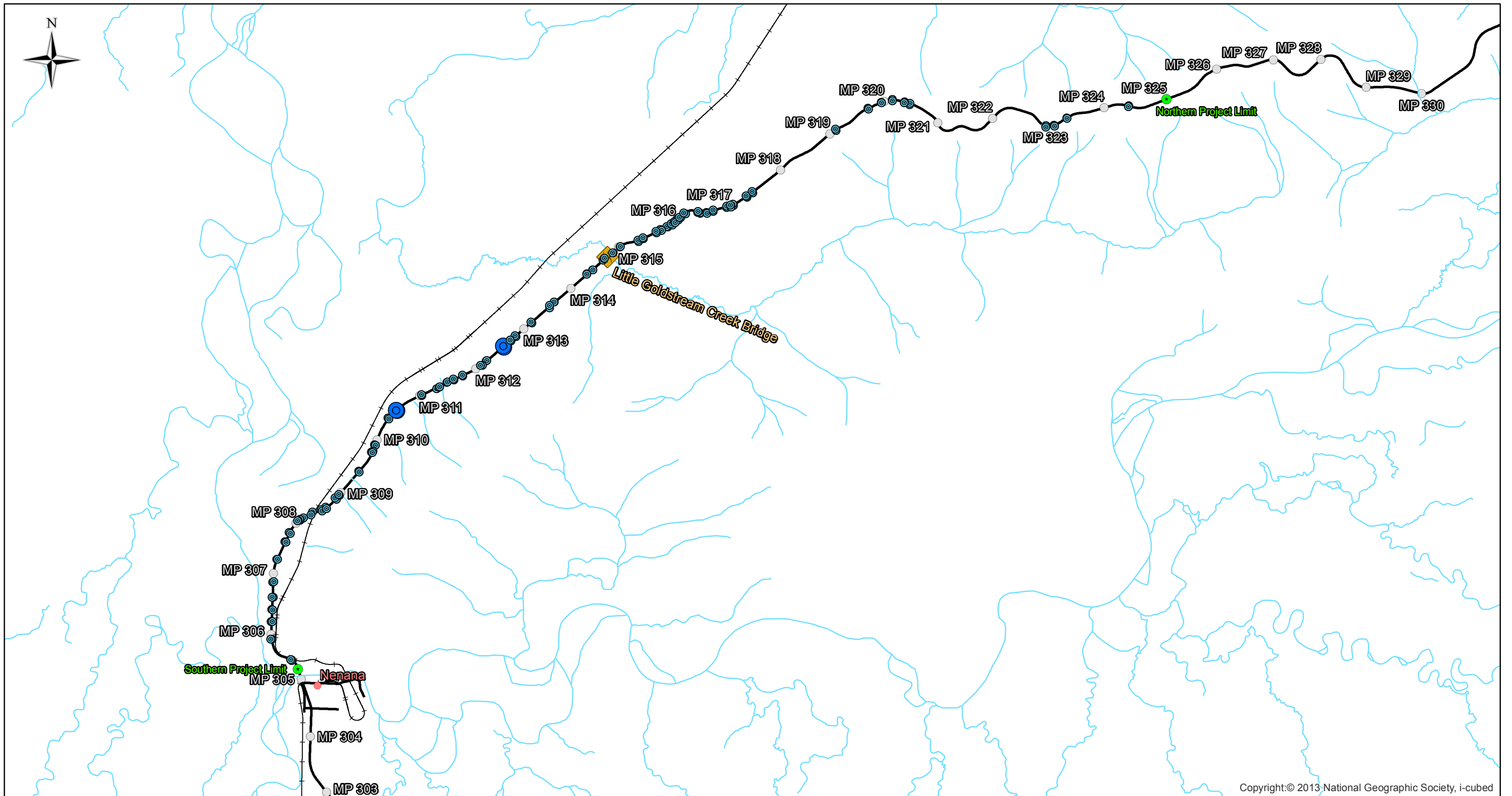

Copyright: © 2013 National Geographic Society, i-cubed



**Alaska Department of  
Transportation & Public Facilities**  
**Parks Highway MP 305 to 325 Reconstruction**  
Project No. 0A45028/Z606570000

Existing Culverts		Legend	
	Major Culvert		AK DOT Milepost
	Minor Culvert		Place Name
	AK DOT Bridge		Project Boundary
			AK DOT Road
			Railroad

**Figure 1.1 Project Overview Map**  
Scale: 1:95,040    1 inch = 1.5 miles  
0    0.75    1.5    3  
Miles  
Fairbanks Custom Projection  
1983 (2011) North American Datum

3/17/2016



## 1.1 BACKGROUND DATA

Location and elevation data were assembled through various sources to support this preliminary H&H study effort. Data used for this study includes; Design Alaska, Inc. survey data, Michael Baker field data, aerial imagery, terrain data, and third party reports.

Between September 9, 2015 and November 19, 2015, Design Alaska, Inc. conducted a survey of the project corridor. This included a survey of Little Goldstream Creek Bridge No. 678, and a bathymetric survey of Little Goldstream Creek, collecting points in the channel, at the top of bank (TOB), ordinary high water (OHW) marks, and the edge of water. Culvert locations were identified through past DOT&PF as-built surveys, through visible observation, and inlet and outlet invert elevations were surveyed during the Design Alaska effort. Light Detection and Ranging (LiDAR) mapping for the project corridor was used to generate ground surface data. Coordinates were collected in World Geodetic System 1984 (WGS84) and translated to a low distortion grid coordinate system established by DOT&PF named "Fairbanks 05-15-15". Elevations were calculated using the Geoid 12B model, North American Vertical Datum of 1988 (NAVD88) datum (Design Alaska 2015).

Between September 21 and September 24, 2015, Michael Baker conducted wetland field studies within the project corridor, including at Little Goldstream Creek and at five additional unnamed streams (Michael Baker 2016).

## 2. SITE DESCRIPTION

---

The Parks Highway MP 305-325 Reconstruction Project is located between the Tanana River Bridge at Nenana and the Fairbanks North Star Borough boundary. The southern half of the project corridor lies in mostly level terrain with the northern half surrounded by rolling hills and mountains.

Overland runoff generally travels from the east to the west across the highway in streams and gullies between MP 305 to MP 318. The highway transitions from the valley floor and more closely follows the ridgelines between MP 318 and MP 325. Flow is less concentrated along this reach, with fewer defined conveyance features. The largest stream along the corridor is Little Goldstream Creek, which crosses at the approximate center of the project corridor at MP 314.8.

The contributing watersheds are heavily forested, which can contribute to reduced peak flow runoff compared to less densely vegetated watersheds. While the slopes of the watersheds vary greatly along the corridor, the greatest average slopes can be found between MP 308 and MP 313. With the exception of Little Goldstream Creek, the greatest peak flows can be expected to occur along this five mile (mi) stretch.

## 3. EXISTING DRAINAGE STRUCTURES

---

### 3.1 INLETS AND CULVERTS

The North Slough Tanana River Bridge No. 201 is located adjacent to the southern end of the project near MP 305. Drainage from the bridge is captured in two storm drain inlets located on the northwest (southbound) side of the Parks Highway. Flow from the inlets (Photo 3-1) is conveyed into 18-inch (in)

DOT&PF/Federal Project No. Z606570000/OA45028

Michael Baker International Document No. 148830-MBI-HH-RPT

culverts (Photo 3-2 and Photo 3-3) and into the Tanana River. Drainage ditches parallel with the Parks Highway convey runoff from the highway (Photo 3-4).

Based on survey data from Design Alaska, Inc. and aerial imagery, there are 74 culverts within the project corridor. Of those 74 culverts, 72 are smaller than 48-in in diameter. These culverts convey flow either under the Parks Highway or under side roads or driveways intersecting the Parks Highway.

The two large culverts within the project corridor are a 3.2-foot (ft) high (H) x 4.7-ft wide (W) corrugated metal pipe arch (CMPA) culvert (Photo 3-5 and Photo 3-6) and a 48-in corrugated metal pipe (CMP) culvert (Photo 3-7 and Photo 3-8). Both are aligned approximately perpendicular with the Parks Highway, conveying flow from the east side (northbound side) of the highway to the west side (southbound side).

A survey of inlet and outlet invert elevations of both major culverts was conducted by Design Alaska, Inc. The results of that survey are shown in Table 3-1.



**Photo 3-1** Parks Highway MP 305.4 storm drain catch basin inlet, southbound side of road





**Photo 3-2**      Parks Highway MP 305.4 18-in culvert outlet, southbound side of road



**Photo 3-3**      Parks Highway MP 305.5 18-in culvert outlet, southbound side of road





**Photo 3-4** Parks Highway MP 311 drainage ditch, looking southeast from northbound side of road



**Photo 3-5** Parks Highway MP 310.6 3.2-ft H x 4.7-ft W culvert inlet, northbound side of road





Photo 3-6 Parks Highway MP 310.6 3.2-ft H x 4.7-ft W culvert outlet, southbound side of road



Photo 3-7 Parks Highway MP 312.6 48-in culvert inlet, northbound side of road





Photo 3-8 Parks Highway MP 312.6 48-in culvert outlet, southbound side of road

Table 3-1 Project Corridor Major Culverts

Size	MP	Design Alaska Survey Point (Inlet)	Design Alaska Survey Point (Outlet)	Inlet Invert Elevation (ft)	Outlet Invert Elevation (ft)	Slope (%)	Inlet Latitude (WGS84)	Inlet Longitude (WGS84)
<b>3.2-ft H x 4.7-ft W</b>	310.6	6715	6731	378.4	377.7	0.8	64.62810°	149.05524°
<b>48-in</b>	312.6	7288	7304	437.6	434.5	2.3	64.64355°	148.99861°

Siltation along drainage ditches and at the inlet and outlet of a 24-in culvert at MP 309.6 was observed during the Michael Baker field visit on September 17, 2015 (Photo 3-9). Lack of conveyance due to a gentle longitudinal slope of the drainage ditch likely contributed to aggregation of fine sediments. The ends of the culvert were completely buried in fine sediment which indicates the need for increased conveyance either through increased slope, increased flow area, or a combination of both. Many culvert ends along the project corridor were almost completely or partially covered with brush and/or branches. Accumulation of sediment, debris, and vegetation was also observed inside several culverts.

The need for drainage improvements between MP 316 and MP 318 was identified during a field visit by DOT&PF on May 15, 2015. The presence of a significant number of gullies conveying concentrated flow towards the highway indicates the need for realignment of existing culverts and the installation of new culverts to improve drainage.



Photo 3-9 Parks Highway MP 309.6 culvert siltation

### 3.2 LITTLE GOLDSTREAM CREEK BRIDGE

Little Goldstream Creek Bridge No. 678 (Photo 3-10) was built in 1958 and is located at MP 314.8 of the Parks Highway. The bridge is approximately 150 ft upstream of a wooden foot bridge, 1.6 mi upstream of the Alaska Railroad Corporation (ARRC) mainline and 1.8 mi upstream of a second Little Goldstream Creek Bridge, No. 2080, located on Kenea Drive. Little Goldstream Creek is a small, perennial, sinuous, northwesterly flowing channel at the location of the bridge crossing and runs approximately perpendicular with the Parks Highway, the ARRC mainline, and Kenea Drive at each crossing location.

The bridge is a 67-ft long, 32-ft W three span I-beam bridge with 1.5:1 sloping banks. Within the channel, the bridge is supported by two piers composed of four H-piles supported by cross struts. The as-built profile grade (high chord) elevation is 389.5 ft; the as-built bridge seat (low chord) elevation is 387.38 ft. As-built elevations are based on levels from benchmark (BM) "A" (spike in spruce tree 180 ft of station 2308+00) run December 11, 1958 (USDC 1958). Bridge as-builts are located in Appendix A. The elevations shown on the 1958 as-builts were derived from mean sea level datum of local USGS BMs. The elevations used in the 2015 Design Alaska survey are based on the NAVD88 datum. The high cord elevation from the 2015 Design Alaska survey is equivalent to the bridge grade centerline elevation of 396.11 ft. The high cord elevation from the 1958 as-builts is equivalent to the bridge grade elevation of 389.50 ft. The elevation difference of the high chord of the bridge between the 1958 as-builts and the 2015 Design Alaska survey is 6.61 ft.

Michael Baker field data and a 2012 Routine Inspection Report for Little Goldstream Creek Bridge No. 678 (DOT&PF 2012) note erosion on the north and south abutments (Photo 3-11 and Photo 3-12), surface rust near the ground line, and minor cracking of the piles. The 2012 Routine Inspection Report provides a



historic profile of the channel at the bridge crossing from 1998 to 2012, suggesting only moderate aggradation/degradation of the channel at the bridge.

Evidence of rilling down the bank is visible in Photo 3-12. A second field visit performed on April 25, 2016 revealed that the rilling is due to bridge drainage ducts and is minimal. The bank material that was previously thought to have been missing due to erosion, is in fact do to subsidence and not erosive forces of overland runoff or channel flow.



**Photo 3-10 Little Goldstream Creek Bridge No. 678, looking downstream (Northwest)**



**Photo 3-11 Little Goldstream Creek Bridge No. 678 North Bridge Abutment**





Photo 3-12 Little Goldstream Creek Bridge No. 678 South Bridge Abutment

## 4. HYDROLOGY

---

### 4.1 PROJECT CORRIDOR WATERSHED

The region the Parks Highway MP 305-325 Reconstruction Project averages 10.8 in of annual precipitation, with 65 in of average annual snowfall. The watersheds contributing flow across the highway typically receive 15 in of precipitation due to the higher elevations.

The U.S. is divided and sub-divided into successively smaller hydrologic units. The Watershed Boundary Dataset maps the full areal extent of surface water drainage for the U.S. using a hierarchical system of nesting the hydrologic units at various scales, each with an assigned hydrologic unit code (HUC). HUCs are delineated and georeferenced to USGS 1:24,000 scale topographic base maps (Seaber et al. 1994). HUC12 delineated watersheds are the smallest hydrologic unit delineated. The HUC12 watersheds contributing to the project corridor are shown in Figure 4-1.

The project corridor begins near the western edge of the City of Nenana – Tanana River HUC12 watershed. Runoff from this watershed within the project corridor is conveyed directly into the Tanana River through storm drains and eight 18-in and 24-in culverts.

Further north in the Nunivak Slough – Tanana River HUC12 watershed (approximately MP 305 to MP 312), slopes east of the road are fairly flat which contributes to lower peak flows. Slopes near the highway along the east side of the road are steeper towards the northern extent of the watershed, contributing to greater peak flows. Slopes in the watershed range between 1.5 to 20 degrees. The section of highway in

DOT&PF/Federal Project No. Z606570000/OA45028

Michael Baker International Document No. 148830-MBI-HH-RPT

the Nunivak Slough – Tanana River HUC12 watershed has 29 small diameter (less than 48 in) CMP culverts and one 3.2-ft H x 4.7-ft W CMPA culvert.

Moving northeast into the Little Goldstream Creek HUC12 watershed (approximately MP 312 to MP 320), slopes range between 2 and 22 degrees. The steepest slopes are found closer to the headwaters (HW) of the watersheds. Closer to Little Goldstream Creek, slopes east of the road become more gradual closer to the road and continue to be gradual approaching the northeastern extent of the watershed. There are 33 small diameter CMP culverts, one 48-in CMP culvert, and Little Goldstream Creek Bridge No. 678 along the section of highway within the Little Goldstream Creek HUC12 watershed.

Between MP 320 and MP 325, the Parks Highway follows a series of ridgelines as the road passes through the HWs Little Goldstream Creek HUC12 watershed. MP 325 represents the high point of the project corridor. There are 10 small diameter CMP culverts along this section of the highway within the HWs Little Goldstream Creek HUC12 watershed and only non-concentrated surface flows across the highway can be expected.

Besides peak flows through Little Goldstream Creek Bridge No. 678, culverts between MP 308 and MP 313 can expect to receive the greatest peak flows based on the size of the basins and the overall slope of the watersheds.

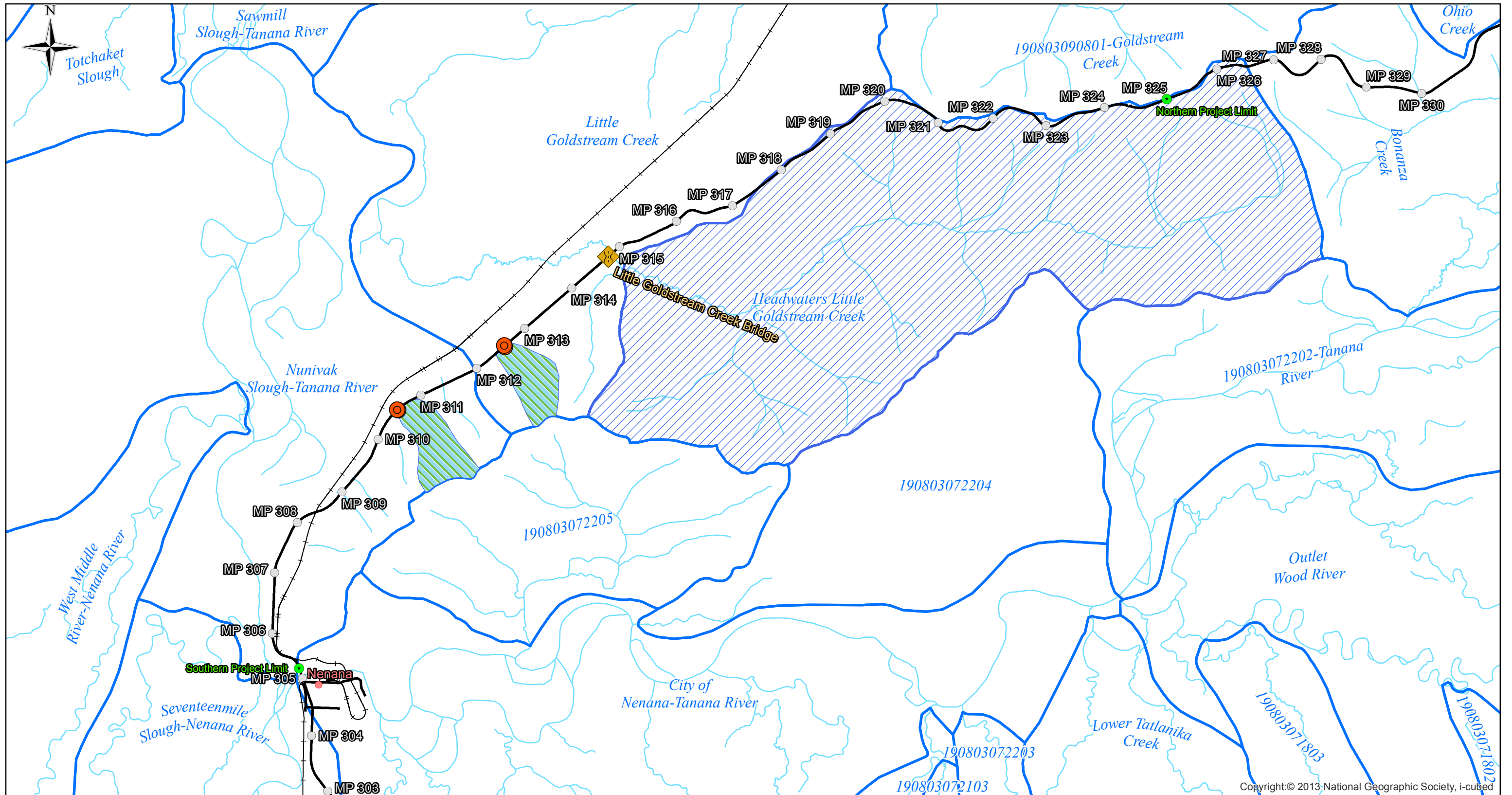

Copyright: © 2013 National Geographic Society, i-cubed



**Alaska Department of  
Transportation & Public Facilities**  
**Parks Highway MP 305 to 325 Reconstruction**  
Project No. 0A45028/Z606570000

- Legend**
- Major Culvert
  - AK DOT Milepost
  - Place Name
  - Project Boundary
  - AK DOT Bridge
  - AK DOT Road
  - Railroad
  - Existing Major Culvert Basin
  - USGS HUC 12 Boundary
  - Headwaters Little Goldstream Creek HUC 12 Boundary

**Figure 4.1  
HUC 12 Watersheds**

Scale: 1:95,040    1 inch = 1.5 miles

0    0.75    1.5    3  
Miles

Fairbanks Custom Projection  
1983 (2011) North American Datum

3/17/2016

In addition to Little Goldstream Creek, the National Hydrologic Database (NHD) includes five unnamed streams that cross the project corridor. These are located between MP 309 and MP 311.5 and all flow from the eastern side of the highway towards the northwest (Table 4-1).

**Table 4-1 Parks Highway Project Corridor NHD Streams**

Stream Name	Location (MP)
Unnamed	309
Unnamed	309.25
Unnamed	310
Unnamed	310.75
Unnamed	311.25
Little Goldstream Creek	314.8

Field studies were conducted by Michael Baker wetlands specialists from September 21-24, 2015. The results of the field studies indicate Little Goldstream Creek is a perennial stream. The other five NHD streams listed in Table 4-1 above were found to be dry swales (three with culverts) with no distinct observations of beds, banks, or OHW marks (Michael Baker 2016).

## 4.2 EXISTING MAJOR CULVERTS

### WATERSHED

Drainage to the 3.2-ft H x 4.7-ft W CMPA culvert at MP 310.6 initiates in the hills southeast of the Parks Highway and flows northwest, running approximately parallel with the Parks Highway between MP 310.5 and MP 310.9. Drainage to the 48-in CMP culvert at MP 312.6 initiates in the hills southeast of the Parks Highway and flows northwest, running approximately parallel with the Parks Highway between MP 312.4 and MP 312.7. Watershed characteristics for the major culverts are summarized in Table 4-2.

**Table 4-2 Major Culvert Watershed Characteristics**

Size	Regression Region	Watershed Area (mi <sup>2</sup> )	Water Surface Slope (ft/ft)	Mean Watershed Elevation (ft)	Mean Annual Precipitation (in)	Area of Lakes and Ponds (Storage) (%)	Area of Glaciers (%)
3.2-ft H x 4.7-ft W	6	0.81	0.042	876	15	0.0	0.0
48-in	6	0.96	0.042	920	15	0.0	0.0

### FLOOD FREQUENCY

Estimates of the magnitude and frequency of peak streamflows at the existing 48-in CMP culvert and 3.2-ft H x 4.7-ft W CMPA culvert were determined for the 2%, 1%, 0.5%, and 0.2% annual chance exceedance intervals using USGS Regression Equations (Curran et al. 2003). These are presented in cubic feet per second (cfs) in Table 4-3.

**Table 4-3 Major Culvert Peak Streamflow (cfs) for the Annual Percent Chance Exceedance**

Size	Annual Percent Chance Exceedance			
	2	1	0.5	0.2
3.2-ft H x 4.7-ft W	62	77	92	116
48-in	53	65	78	98

**FISH PASSAGE**

Culverts transport flows from ephemeral drainage paths that do not support fish habitat therefore fish passage criteria do not apply to the design.

**PEAK DISCHARGE**

There is no historical peak discharge (flood of record) data available for the two existing major culverts.

**4.3 LITTLE GOLDSTREAM CREEK BRIDGE**

**WATERSHED**

Little Goldstream Creek initiates in the hills on the south side of the Parks Highway and flows southwest, running approximately parallel with the Parks Highway between MP 326.5 and MP 316.5. At approximately MP 316.5, the channel turns northwest and flows under the Parks Highway at the Little Goldstream Creek Bridge No. 678 at MP 314.8. Little Goldstream Creek continues to flow generally west and then turns northeast and converges with Goldstream Creek. Goldstream Creek flows in the Chatanika River at Minto Flats, the Tatalina River, the Tolovana River, and finally into the Tanana River.

Watershed characteristics for the Little Goldstream Creek Bridge No. 678 are summarized in Table 4-4.

**Table 4-4 Little Goldstream Creek Bridge No. 678 Watershed Characteristics**

Regression Region	Watershed Area (mi <sup>2</sup> )	Mean Basin Elevation (ft)	Mean Annual Precipitation (in)	Area of Lakes and Ponds (Storage) (%)	Area of Glaciers (%)
6	41.7	678	15	0.35	0.0

**FLOOD FREQUENCY**

Estimates of the magnitude and frequency of peak streamflows at the Little Goldstream Creek Bridge No. 678 were determined for the 2%, 1%, 0.5% and 0.2% annual chance exceedance intervals using USGS Regression Equations (Curran et al. 2003) and are presented in Table 4-5.

**Table 4-5 Little Goldstream Creek Bridge No. 678 Peak Streamflow (cfs) for the Annual Percent Chance Exceedance**

2%	1%	0.5%	0.2%
1,317	1,555	1,806	2,162

**FISH PASSAGE**

Little Goldstream Creek is not listed in the Anadromous Waters Catalog or the Alaska Freshwater Fish Inventory database. Little Goldstream Creek likely has high water event hydraulic connections with neighboring waterbodies in the Minto Flats that are known to contain resident fish populations (Michael Baker 2016). It is therefore assumed that Little Goldstream Creek likely hosts resident fish populations and the bridge design will incorporate a natural channel bottom to accommodate fish passage.

**PEAK DISCHARGE**

USGS gage station 15540070, Little Goldstream Creek near Nenana, was located approximately 900 ft upstream of the Little Goldstream Creek Bridge No. 678. The gage was in operation from 1967 through 1981. A historical peak discharge (flood of record) of 1,490 cfs was reported at the gage station in August 1967. There is no flood of record elevation available. The design frequency for the bridge and the historic peak discharge relationship are summarized in Table 4-6.

**Table 4-6 Little Goldstream Creek Bridge No. 678 Design Frequency versus Historic Peak Discharge**

1% Annual Chance Exceedance (cfs)	1967 Historic Peak Discharge (cfs)
1,555	1,490

The 1967 historic peak discharge was less than 1% annual chance exceedance.

**5. HYDRAULICS**

**5.1 CULVERTS**

Based on the proposed alignment within the project corridor of the Parks Highway MP 305-325 Reconstruction Project, a preliminary drainage analysis has identified the need for six additional culverts and two storm drain inlets to facilitate efficient drainage along the project corridor. The total number of culverts along the project corridor is proposed to be increased to 80. See Figure 5-1 for the existing and proposed locations of all minor and major culverts along the project corridor.



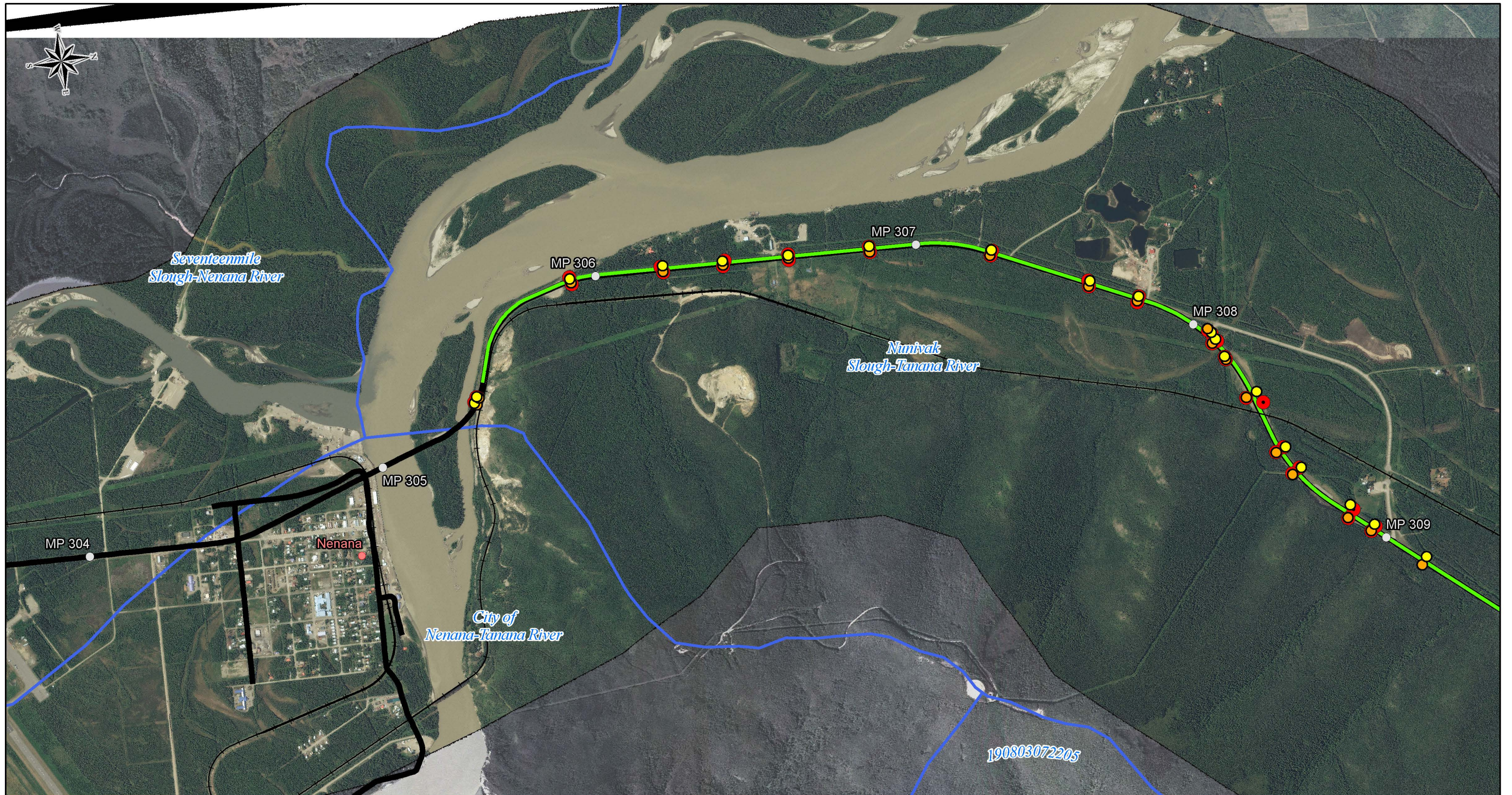

**Alaska Department of  
Transportation & Public Facilities**  
**Parks Highway MP 305 to 325 Reconstruction**  
 Project No. 0A45028/Z606570000

**Legend**

○ AK DOT Milepost	— AK DOT Road	⊞ USGS HUC12 Boundary
● Proposed Culvert	— Sketch Plan2 Alignment	— Railroad
● Downstream		
● Upstream		
● Existing Culvert		
● Minor Culvert		
● Place Name		

**Existing & Proposed  
Culvert Locations**  
 Scale: 1:18,000    1 inch = 1,500 feet  
 0    750    1,500    3,000  
 Feet  
 Fairbanks Custom Projection  
 1983 (2011) North American Datum

3/21/2016    Page 1 of 5





**Alaska Department of  
Transportation & Public Facilities**  
**Parks Highway MP 305 to 325 Reconstruction**  
 Project No. 0A45028/Z606570000

Legend	
○ AK DOT Milepost	— AK DOT Road
● Proposed Culvert	— Sketch Plan2 Alignment
● Downstream	— Railroad
● Upstream	— USGS HUC12 Boundary
○ Existing Culvert	— Proposed Major Culvert Basin
○ Major Culvert	— Existing Major Culvert Basin
● Minor Culvert	

**Existing & Proposed  
Culvert Locations**  
 Scale: 1:18,000    1 inch = 1,500 feet  
 0    750    1,500    3,000  
 Feet  
 Fairbanks Custom Projection  
 1983 (2011) North American Datum



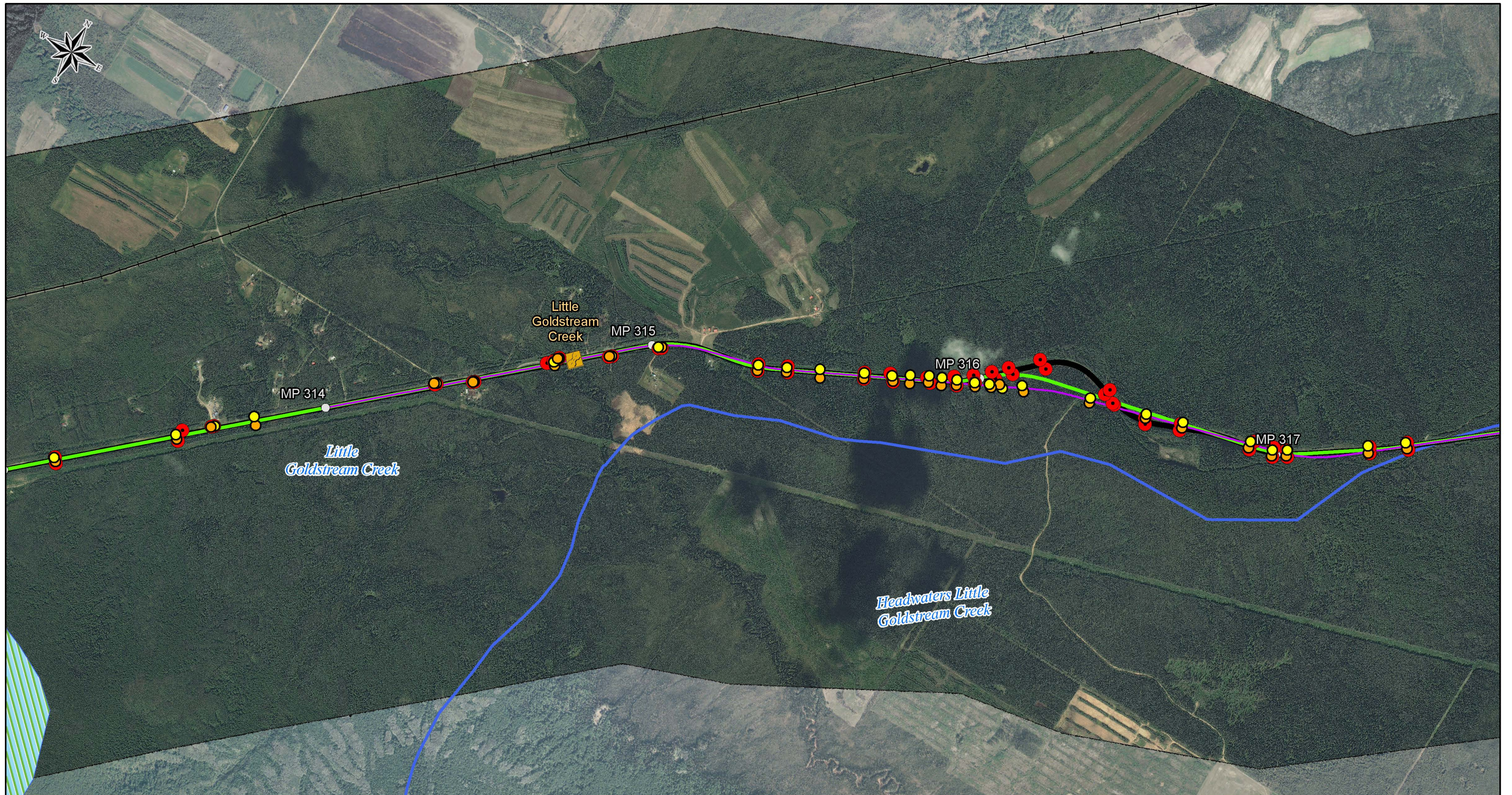

**Alaska Department of  
Transportation & Public Facilities**  
**Parks Highway MP 305 to 325 Reconstruction**  
 Project No. 0A45028/Z606570000

**Legend**

AK DOT Milepost	AK DOT Road	USGS HUC12 Boundary
AK DOT Bridge	Sketch Plan1 Alignment	Existing Major Culvert Basin
Sketch Plan2 Alignment	Railroad	
<b>Proposed Culvert</b>		
Downstream		
Upstream		
<b>Existing Culvert</b>		
Minor Culvert		

**Existing & Proposed  
Culvert Locations**  
 Scale: 1:18,000    1 inch = 1,500 feet  
 0    750    1,500    3,000  
 Feet  
 Fairbanks Custom Projection  
 1983 (2011) North American Datum



3/21/2016    Page 3 of 5



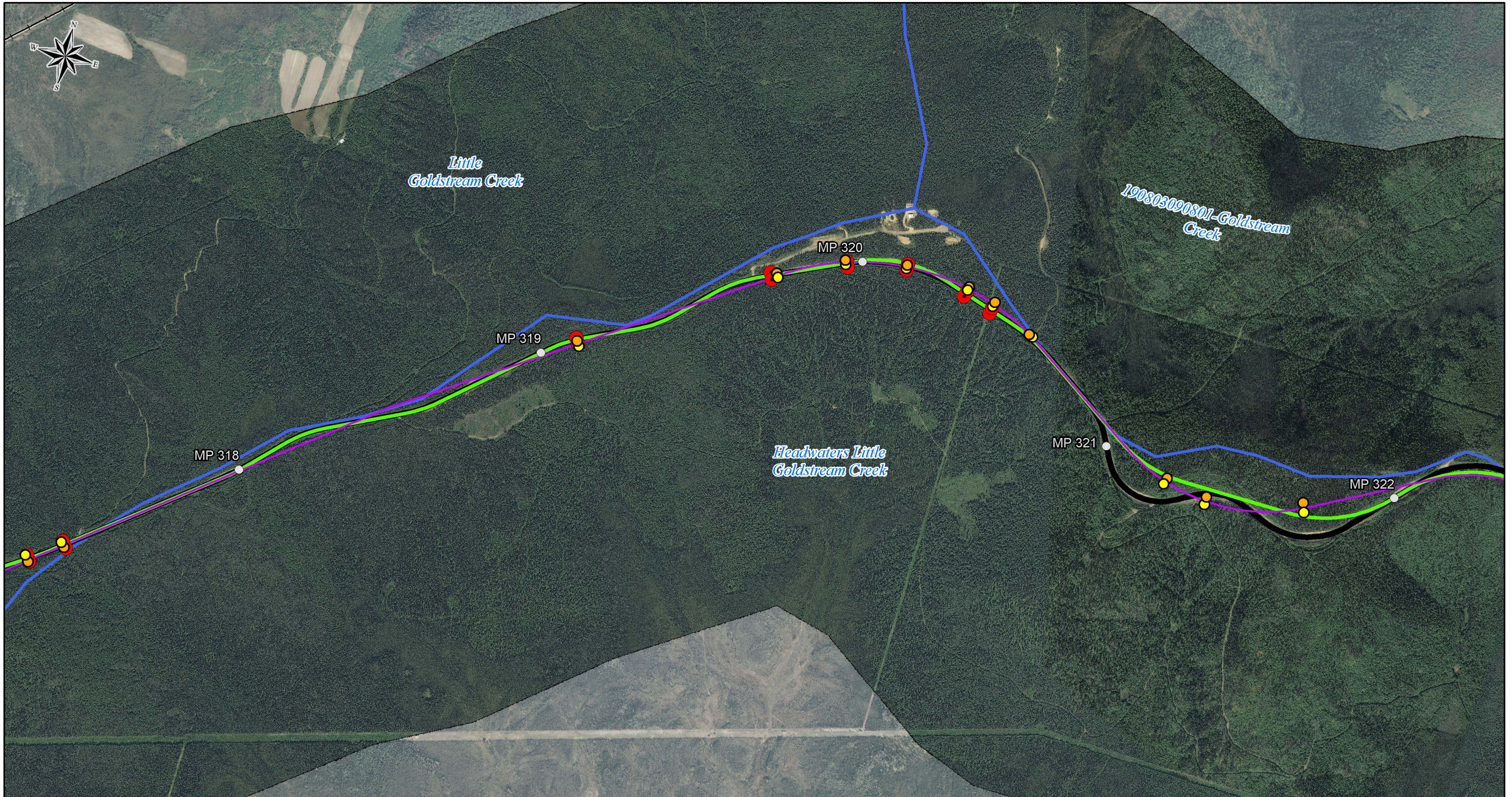

**Alaska Department of  
Transportation & Public Facilities**  
**Parks Highway MP 305 to 325 Reconstruction**  
 Project No. 0A45028/Z606570000

**Legend**

○ AK DOT Milepost	— AK DOT Road	⬜ USGS HUC12 Boundary
● Downstream	— Sketch Plan1 Alignment	
● Upstream	— Sketch Plan2 Alignment	
● Minor Culvert	— Railroad	

**Existing & Proposed  
Culvert Locations**  
 Scale: 1:18,000    1 inch = 1,500 feet  
 0    750    1,500    3,000  
 Feet  
 Fairbanks Custom Projection  
 1983 (2011) North American Datum

3/21/2016    Page 4 of 5



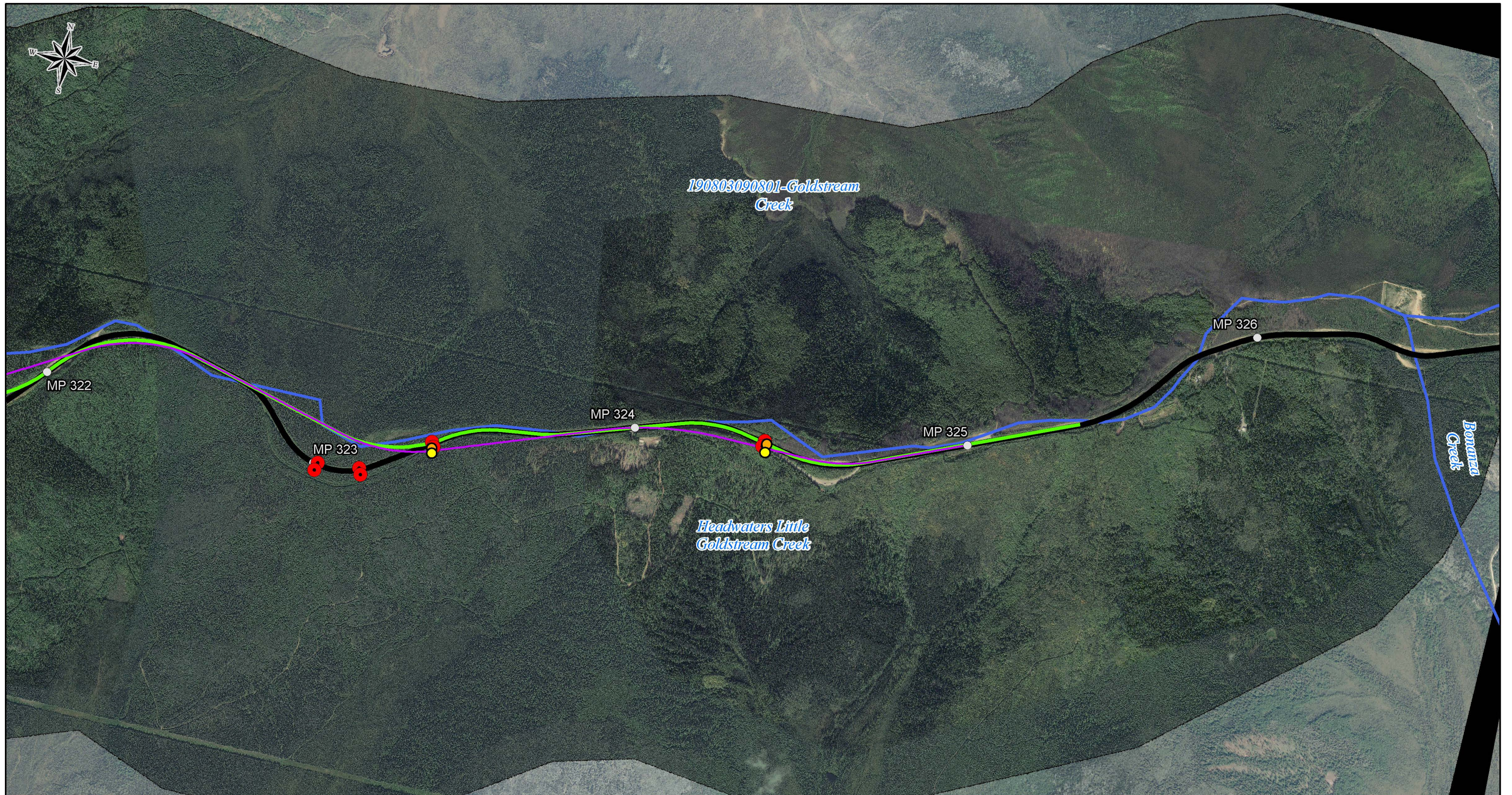

**Alaska Department of  
Transportation & Public Facilities**  
**Parks Highway MP 305 to 325 Reconstruction**  
 Project No. 0A45028/Z606570000

**Legend**

AK DOT Milepost	AK DOT Road	USGS HUC12 Boundary
<b>Proposed Culvert</b>	Sketch Plan1 Alignment	
Downstream	Sketch Plan2 Alignment	
Upstream		
<b>Existing Culvert</b>		
Minor Culvert		

**Existing & Proposed  
Culvert Locations**  
 Scale: 1:18,000    1 inch = 1,500 feet  
 0    750    1,500    3,000  
 Feet  
 Fairbanks Custom Projection  
 1983 (2011) North American Datum

3/21/2016    Page 5 of 5



Due to the reconfiguration along certain sections of the road alignment, existing culverts need to be relocated accordingly. Culverts along the corridor are proposed to be installed perpendicular with the new alignment. However, when the final road alignment has been determined, specific drainage concerns might require a culvert to be installed at a skewed angle.

A DOT&PF field visit on May 15, 2015 identified the need for new culverts in the vicinity of MP 316 to improve cross drainage due to concentrated flows through a large number of gullies. Based on observed conditions, four new 24-in culverts have been proposed at this section of the road. Final design might require installation of additional culverts due to the large number of gullies conveying flow towards the road.

To improve conveyance, it is proposed that 11 existing 24-in CMP culverts between MP 309 and MP 313 are replaced with 36-in CMP culverts. The greater flow capacity of a 36-in CMP culvert should alleviate sedimentation, ice buildup, and accumulation of debris within the culvert barrel. New 36-in culverts are proposed near MPs 309.1, 309.7, 309.8, and 311.15. Furthermore, a new 24-in culvert is proposed near MP 313.8.

Localized regrading of adjacent drainage ditches may be necessary to help increase flow velocity upstream of the culverts which would reduce deposition of sediment at the inlets. Alternatively, sediment basins can be installed to intercept and trap sediment before it reaches the culvert inlets. Drainage ditches along the corridor should be rehabilitated to improve overall conveyance along the highway. Culvert slopes will be chosen to approximate existing topography and culvert entrances will be installed to be aligned with the toe of the embankment (AHDM 2006).

Two existing 24-in CMP culverts, one located at MP 310.4 and the other at MP 312.1, do not meet design flood discharge criteria (defined as the 50-year flood computed using USGS Regression Equations [Curran et al. 2003]). It is recommended that the 24-in CMP culvert at MP 310.4 and the 24-in CMP culvert at MP 312.1 should be replaced with 48-in CMP culverts to facilitate improved drainage under the highway. While a 36-in CMP culvert meets the required HW depth to the diameter (D), height, or rise of a culvert entrance (HW/D) of 1.5 for a 50-year flood event at both locations, potential icing conditions warrants oversizing the culverts.

The existing 3.2-ft H x 4.7-ft W CMPA culvert at MP 310.6 should be analyzed at the design level for replacement. While the existing culvert meets the design criteria, a risk analysis for overtopping using the 500-year flood event should be considered. If necessary, replacing the existing culvert with either a 54-in CMP, 2-48-in CMPs, a 48-in concrete box, or a 46-in x 60-in CMPA culvert, will ensure design criteria are met and overtopping potential is limited.

The existing 48-in CMP culvert at MP 312.6, located at N 64.6437° and W 148.9987° (WGS84), meets the design criteria. Table 5-1 shows the proposed/modified major culvert sizes.

**Table 5-1 Proposed/Modified Culvert Size and Location**

Existing MP	Proposed MP	Existing Size	Proposed Size
310.4	310.4	24-in CMP	48-in CMP
310.6	310.6	3.2-ft x 4.7-ft CMPA	54-in CMP, 2-48-in CMP, Concrete Box 48-in or 46-in x 60-in CMPA
312.1	312.1	24-in CMP	48-in CMP

## OVERTOPPING FLOOD

The existing 48-in CMP culvert is located at a road sag at MP 312.6. The surveyed elevations of the culvert invert and the road centerline are 437.6 ft and 454.9 ft, respectively. The elevation difference of 17.3 ft is significantly greater than the calculated HW depth of 5.7 ft needed to convey the 500-year flood event discharge of 98 cfs. The water surface elevation (WSE) for a 500-year storm event is approximately 443.3 ft. Overtopping of the road at the location of the existing 48-in CMP culvert is not expected. No specific backwater restrictions have been identified.

The existing 3.2-ft H x 4.7-ft W CMPA culvert is not located at a road sag at MP 310.6. The surveyed elevations of the culvert invert and the road centerline are 378.4 ft and 385.2 ft, respectively. The elevation difference of 6.8 ft is greater than the HW depth of 6.6 ft required to convey the 500-year flood event of 116 cfs. However, under those conditions, the road would be close to being overtopped. By replacing the existing arch culvert with a 54-in CMP culvert, 2-48-in CMP culverts, a 48-in concrete box, or a 46-in H x 60-in W CMPA culvert, the HW depths for a 500-year flood event are calculated to be 5.8 ft, 3.6 ft, 5.1 ft and 5.3 ft, respectively. Road overtopping is therefore less likely with any of these options. No specific backwater restrictions have been identified.

The 24-in CMP culvert proposed for replacement with a 48-in CMP culvert at MP 310.4 is located at a road sag. The culvert invert elevation and the road centerline elevation are 363.1 ft and 367.6 ft, respectively; the elevation difference of 4.5 ft. The calculated HW to convey the 500-year flood of 67 cfs is estimated to be 4.1 ft. The WSE elevation for a 500-year storm event is approximately 367.2 ft. Therefore, road overtopping is not expected, although the anticipated WSE will be close, 0.4 ft lower than the road. No specific backwater restrictions have been identified.

The road is sloping to the southwest at MP 312.1 where a 48-in CMP culvert is proposed to replace the existing 24-in CMP culvert. However, the existing culvert is surrounded by higher ground so significant water accumulation at the culvert can be expected. For a 48-in CMP culvert the calculated HW to convey a 500-year flood of 72 cfs event is 4.2 ft. The culvert invert elevation and the road centerline elevation are 433.0 ft and 447.3 ft, respectively, a difference of 14.3 ft. The WSE elevation for a 500-year storm event is approximately 437.2 ft. No road overtopping is expected at the location of the proposed 48-in CMP culvert. No specific backwater restrictions have been identified.

All other culverts are anticipated to remain in place.

## 5.2 LITTLE GOLDSTREAM CREEK BRIDGE

The existing Little Goldstream Creek Bridge No. 678 is recommended for replacement with a span of approximately 120 ft, and a width of 56 ft. There will be no piers within the channel. The increased span allows for full capacity of the 1 percent annual flow, thus eliminating abutment scour forces and the increased width along the stream channel will accommodate four lanes of travel with shoulders on each side of the road as well. The current bridge has width that includes two lanes of traffic with no shoulders, thus the widening will reduce safety concerns at this site.

### HYDRAULIC HISTORY

Based on the Little Goldstream Creek Bridge No. 678 as-built drawings dated March 7, 1958, the Little Goldstream Creek active channel upstream and downstream of the bridge was widened to 15 ft at the streambed and shifted to achieve a 90 degree angle between the highway and the downstream channel.

Approximately 70 ft upstream of the bridge, the channel was shifted to achieve a bend radius of 92.5 ft which then transitioned to a 32.5 ft bend radius. Approximately 16 ft upstream of the highway centerline, the 32.5 ft bend radius transitions to a tangent and continues straight under the bridge for a distance of 160 ft from the highway centerline (a total tangent distance of 176 ft). Under low flow conditions, the direction of flow is skewed toward the right bank. Under high flow conditions, the direction of flow is perpendicular with the bridge opening.

#### 5.2.1.1 Tidal

No tidal influence extends to Little Goldstream Creek.

#### 5.2.1.2 Nontidal

Little Goldstream Creek is moderately small with the maximum recorded discharge being 1,490 cfs. It flows along a low-gradient reach before passing under Little Goldstream Creek Bridge No. 678. The stream has an active channel approximately 17 ft wide and an average of 4-ft deep at the bridge.

#### 5.2.1.3 Navigation

Navigation downstream of Little Goldstream Creek, in Goldstream Creek, is currently limited during low water by mud shallows in Bridge Lake. During high water, the channel through the infilled lake is passable (ADF&G 1987). The narrow channel of Little Goldstream Creek and observed woody debris make this stream an unlikely candidate for active navigation.

#### 5.2.1.4 Confluence

Approximately 0.5 mi upstream of Little Goldstream Creek Bridge No. 678 is the convergence of Little Goldstream Creek and a minor tributary. No impacts to confluences are expected.

#### 5.2.1.5 Mining Activity

Although mining activity has been prevalent in the Goldstream Creek valley, there is little evidence of mining along the reach of Little Goldstream Creek in the vicinity of the bridge. There are no observable mining efforts downstream of the bridge.

#### 5.2.1.6 Debris

During the Michael Baker site visit in the fall of 2015, downed trees were found along the banks of Little Goldstream Creek (Photo 3-1). This is a heavily vegetated watershed and woody debris is expected throughout much of the channel.

Bedload, although not measured, is expected to be composed primarily of sand, gravel, and small cobble based on observed bed and bank material during the site visit.

Debris flows are not expected in this watershed as slopes are not excessive and appear to be stable from review of aerial photography in the basin. There are no glaciers or lakes in the



**Photo 5-1** Little Goldstream Creek debris, looking downstream

watershed and therefore limited potential for large mass wasting due to geofluvial contributions of material associated with lake pulses or mass glacial wasting.

**5.2.2 BACKWATER**

A backwater analysis of the existing structure (or natural channel) versus the proposed structure(s) during a high water event that has an exceedance probability equal to 1 percent shows that the proposed structure does not increase the water surface elevation. Results are shown in Table 5-2.

**Table 5-2 HEC-RAS Results for Proposed and Existing Little Goldstream Creek Bridge**

	Existing Bridge	Proposed 70 ft Span	Proposed 90 ft Span	Proposed 120 ft Span
1% WSE	391.70	391.68	391.68	391.68
0.2% WSE	392.99	392.81	391.80	392.81

**HYDRAULIC DESIGN**

The one-dimensional step backwater model HEC-RAS 4.1.0, developed by the U.S. Army Corps of Engineers (USACE 2010), was used to model design flows and extract information for use in developing proposed bridge design criteria. The model output is included in 6.Appendix B. Proposed bridge geometries were incorporated into the model. All modeling was performed under steady state conditions with a subcritical flow regime. An existing conditions model was developed by DOT&PF in 1999 using as-built bridge geometry (DOT&PF 1999).



**5.2.1.7 Cross Sections and Bridge Geometry**

HEC-RAS geometry input data was developed in AutoCAD Civil 3D. HEC-RAS cross sections were aligned perpendicular to overbank flow and as near to perpendicular to channel flow as possible. Design Alaska bathymetric survey data was used for channel elevations and Design Alaska, Inc. LiDAR data was used for the cross section overbank topography. Bank stations were delineated along the surveyed TOB. Each cross section was delineated to encompass the limits of the floodplain. The cross sections and existing HEC-RAS Output Data for Little Goldstream Creek Bridge No. 678 are shown in Figure 5-2. The model was configured to compute energy losses through the bridge using the energy equation (standard step method) and momentum balance, applying the greater of the two to the final solution. Final model solutions were evaluated for equivalent conveyance upstream and downstream of the bridge.





Alaska Department of  
Transportation & Public Facilities  
**Parks Highway MP 305 to 325 Reconstruction**  
Project No. 0A45028/Z606570000

**Legend**  
 AK DOT Bridge  
 HEC-RAS Cross Section  
 AK DOT Road

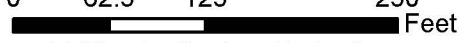
**HEC-RAS  
Cross Sections**  
 Scale: 1:1,500      1 inch = 125 feet  
 0    62.5    125    250  
 Feet  
 Fairbanks Custom Projection  
 1983 (2011) North American Datum



3/17/2016



**5.2.1.8 Model Validation**

The model was run as subcritical flow with the boundary conditions for the 100- and 500-year recurrence interval peak streamflows. A normal depth slope of 0.0015 was assigned. This is the average value of the energy grade slope at all of the cross sections upstream of the downstream most cross section. This is also based on several estimates of the channel slope downstream of the bridge using USGS topography.

**5.2.1.9 Bridge Design Model**

Three versions of open bridge spans were modeled at 70 ft, 90 ft, and 120 ft. The alternative geometries were analyzed for WSE, backwater, and scour. Abutments are assumed to be at a 3:1 slope and it is assumed the bridge will be a clear span with no supporting piers.

**5.2.1.10 Flood Impacts**

The channel configuration of Little Goldstream Creek downstream of the Parks Highway crossing is a relatively narrow, confined channel with a broad floodplain. The bridge does not impact flooding at the 70 ft, 90 ft, or 120 ft span.

**5.2.1.11 Deck Drainage**

Deck drainage is recommended if the 120 ft span bridge is selected for final design.

**SCOUR**

**5.2.1.12 Existing Conditions**

The Alaska DOT&PF conducted a bridge sounding of Little Goldstream Creek Bridge No. 678 on August 20, 1967 to establish hydraulic variables for use in the construction of a hydraulic model for analyses of streambed scour. The hydraulic variables used to construct the hydraulic model are summarized in Table 5-3 (USGS 2004).

**Table 5-3 Little Goldstream Creek Bridge No. 678 Hydraulic Variables**

Discharge (cfs)		Water Surface Slope (ft/ft)	Manning’s Roughness Coefficient		Minimum Bed Elevation (ft)	
Q <sub>100</sub>	Q <sub>500</sub>		Channel	Overbank	Measured	As-Built
2,260	2,870	0.0025	0.040	0.045	373.5	373.6

Computed Phase 1.5 scour depths for the 100- and 500-year recurrence intervals calculated using Jones and Fahl 1994 equations at Little Goldstream Creek Bridge No. 678 are summarized in Table 5-4 (USGS 2004).

**Table 5-4 Little Goldstream Creek Bridge No. 678 Computed Scour Depth (ft)**

Contraction Scour		Pier Scour		Pressure Scour		Total Scour	
Q <sub>100</sub>	Q <sub>500</sub>	Q <sub>100</sub>	Q <sub>500</sub>	Q <sub>100</sub>	Q <sub>500</sub>	Q <sub>100</sub>	Q <sub>500</sub>
2.2	3.0	3.5	3.8	2.1	0.2	7.8	7.0

Hydraulic variables used in the computation of contraction-, pier-, and pressure-scour are summarized in Table 5-5, Table 5-6, and Table 5-7 (USGS 2004).

**Table 5-5 Little Goldstream Creek Bridge No. 678 Contraction-Scour Hydraulic Variables**

Width of Approach Channel (ft)		Discharge at Approach (cfs)		Flow Depth in Approach (ft)		Width of Channel at Bridge (ft)		Depth of Flow at Bridge (ft)	
Q <sub>100</sub>	Q <sub>500</sub>	Q <sub>100</sub>	Q <sub>500</sub>	Q <sub>100</sub>	Q <sub>500</sub>	Q <sub>100</sub>	Q <sub>500</sub>	Q <sub>100</sub>	Q <sub>500</sub>
75.0	76.0	1,947	2,357	7.9	8.9	62.0	62.0	7.6	8.6

**Table 5-6 Little Goldstream Creek Bridge No. 678 Pier-Scour Hydraulic Variables**

Froude Number		Depth of Flow at Bridge (ft)		Pier Nose Shape	Angle of Attack (degrees)	K <sub>2</sub>	Pier Width (ft)	Pier Length (ft)	Depth of Flow at Pier (ft)	
Q <sub>100</sub>	Q <sub>500</sub>	Q <sub>100</sub>	Q <sub>500</sub>						Q <sub>100</sub>	Q <sub>500</sub>
0.28	0.31	7.6	8.6	Square	0	1.00	1.0	1.0	13.8	15.6

**Table 5-7 Little Goldstream Creek Bridge No. 678 Pressure-Scour Hydraulic Variables**

Depth at Approach (ft)		Discharge at Approach (cfs)		Area of Approach (ft <sup>2</sup> )		Approach Velocity (ft/s)		Depth of Overflow (ft)		Average Depth at Bridge (ft)	Median Particle Diameter (ft)	Incipient Motion Velocity (ft/s)	
Q <sub>100</sub>	Q <sub>500</sub>	Q <sub>100</sub>	Q <sub>500</sub>	Q <sub>100</sub>	Q <sub>500</sub>	Q <sub>100</sub>	Q <sub>500</sub>	Q <sub>100</sub>	Q <sub>500</sub>			Q <sub>100</sub>	Q <sub>500</sub>
7.8	8.9	1,953	2,355	589	677	3.3	3.5	0	0.6	6.5	0.03281	5.2	5.3

**5.2.1.13 Proposed Conditions**

The hydraulic variables used to construct the hydraulic model for the proposed bridge are summarized in Table 5-8.

**Table 5-8 Proposed Little Goldstream Creek Bridge No. 678 Hydraulic Variables**

Discharge at Bridge (cfs)		Water Surface Slope (ft/ft)		Manning’s Roughness Coefficient		Minimum Bed Elevation (ft)
Q <sub>100</sub>	Q <sub>500</sub>	Q <sub>100</sub>	Q <sub>500</sub>	Channel	Overbank	Surveyed
1,555	2,162	0.0005	0.0005	0.035	0.046	382

Based on the proposed bridge design, it was identified that contraction and abutment scour needs to be investigated for three different bridge deck scenarios:

- 70-ft long bridge deck
- 90-ft long bridge deck
- 120-ft long bridge deck

Contraction scour was calculated using HEC-RAS based on live-bed scour conditions. Live-bed scour is expected based on observed site conditions and calculated mean bed shear stress at the approach section. Abutment scour was calculated using Froehlich’s Abutment Scour Equation where the input data was extracted from HEC-RAS. Long-term degradation of the channel was evaluated using regime theory.

Computed Phase 1.5 scour depths for the 100- and 500-year recurrence intervals calculated using USGS Regression Equations (Curran et al. 2003) at Little Goldstream Creek Bridge No. 678 are summarized in Table 5-9 Table 5-4 using a 70-ft long bridge deck.

**Table 5-9 Proposed Little Goldstream Creek Bridge No. 678 Computed Scour Depth (ft) using a 70- ft Long Bridge Deck**

Contraction Scour		Abutment Scour		Long-Term Scour		Total Scour	
Q <sub>100</sub>	Q <sub>500</sub>	Q <sub>100</sub>	Q <sub>500</sub>	Q <sub>100</sub>	Q <sub>500</sub>	Q <sub>100</sub>	Q <sub>500</sub>
0.0	0.0	3.0	4.7	3.2	3.9	6.1	8.6

Computed Phase 1.5 scour depths for the 100- and 500-year recurrence intervals calculated using USGS Regression Equations (Curran et al. 2003) at Little Goldstream Creek Bridge No. 678 are summarized in Table 5-4 Table 5-10 using a 90-ft long bridge deck.

**Table 5-10 Proposed Little Goldstream Creek Bridge No. 678 Computed Scour Depth (ft) using a 90- ft Long Bridge Deck**

Contraction Scour		Abutment Scour		Long-Term Scour		Total Scour	
Q <sub>100</sub>	Q <sub>500</sub>	Q <sub>100</sub>	Q <sub>500</sub>	Q <sub>100</sub>	Q <sub>500</sub>	Q <sub>100</sub>	Q <sub>500</sub>
0.0	0.0	0.0	3.7	3.2	3.9	3.2	7.6

Computed Phase 1.5 scour depths for the 100- and 500-year recurrence intervals calculated using USGS Regression Equations (Curran et al. 2003) at Little Goldstream Creek Bridge No. 678 are summarized in Table 5-4 Table 5-11 using a 120-ft long bridge deck.

**Table 5-11 Proposed Little Goldstream Creek Bridge No. 678 Computed Scour Depth (ft) using a 120- ft Long Bridge Deck**

Contraction Scour		Abutment Scour		Long-Term Scour		Total Scour	
Q <sub>100</sub>	Q <sub>500</sub>	Q <sub>100</sub>	Q <sub>500</sub>	Q <sub>100</sub>	Q <sub>500</sub>	Q <sub>100</sub>	Q <sub>500</sub>
0.0	0.0	0.0	0.0	3.2	3.9	3.2	3.9

Hydraulic variables used in the computation of contraction and abutment scour are summarized in Table 5-12 through Table 5-18.

**Table 5-12 Proposed Little Goldstream Creek Bridge No. 678 Contraction-Scour Hydraulic Variables**

Width of Approach Channel (ft)		Discharge in Approach Channel (cfs)		Hydraulic Depth of Flow in Approach Channel (ft)		Width of Channel at Bridge (ft)		Hydraulic Depth of Flow at Bridge (ft)	
Q <sub>100</sub>	Q <sub>500</sub>	Q <sub>100</sub>	Q <sub>500</sub>	Q <sub>100</sub>	Q <sub>500</sub>	Q <sub>100</sub>	Q <sub>500</sub>	Q <sub>100</sub>	Q <sub>500</sub>
79	112	1,555	2,162	7.2	8.5	70/90/120	70/90/120	4.9	6.2

**Table 5-13 Proposed Little Goldstream Creek Bridge No. 678 Abutment-Scour Hydraulic Variables using a 70-ft Long Bridge Deck for a 100-Year Flood Event**

Coefficient for Abutment Shape		Coefficient for Angle of Abutment to Flow		Length of Active Flow Obstructed by the Abutment (ft)		Flow Area Obstructed by the Abutment (ft <sup>2</sup> )	
Left/Right		Left/Right		Left	Right	Left	Right
1.0		1.0		11	3	5.5	1.5

**Table 5-14 Proposed Little Goldstream Creek Bridge No. 678 Abutment-Scour Hydraulic Variables using a 70-ft Long Bridge Deck for 100-Year Flood Event**

Flow Obstructed by the Embankment (cfs)		Froude Number		Average Depth of Flow in the Obstructed Area (ft)		Average Velocity of Flow in the Obstructed Area (ft/s)	
Left	Right	Left	Right	Left	Right	Left	Right
6.1	1.8	0.3	0.3	0.5	0.5	1.1	1.2

**Table 5-15 Proposed Little Goldstream Creek Bridge No. 678 Abutment-Scour Hydraulic Variables using a 70-ft Long Bridge Deck for a 500-Year Flood Event**

Coefficient for Abutment Shape	Coefficient for Angle of Abutment to Flow	Length of Active Flow Obstructed by the Abutment (ft)		Flow Area Obstructed by the Abutment (ft <sup>2</sup> )	
Left/Right	Left/Right	Left	Right	Left	Right
1.0	1.0	30	15	24	11

**Table 5-16 Proposed Little Goldstream Creek Bridge No. 678 Abutment-Scour Hydraulic Variables using a 70-ft Long Bridge Deck for a 500-Year Flood Event**

Flow Obstructed by the Abutment (cfs)		Froude Number		Average Depth of Flow in the Obstructed Area (ft)		Average Velocity of Flow in the Obstructed Area (ft/s)	
Left	Right	Left	Right	Left	Right	Left	Right
31	16	0.3	0.3	0.8	0.8	1.3	1.4

**Table 5-17 Proposed Little Goldstream Creek Bridge No. 678 Abutment-Scour Hydraulic Variables using a 90-ft Long Bridge Deck for a 500-Year Flood Event**

Coefficient for Abutment Shape	Coefficient for Angle of Abutment to Flow	Length of Active Flow Obstructed by the Abutment (ft)		Flow Area Obstructed by the Abutment (ft <sup>2</sup> )	
Left/Right	Left/Right	Left	Right	Left	Right
1	1	19	7	9.5	2.8

**Table 5-18 Proposed Little Goldstream Creek Bridge No. 678 Abutment-Scour Hydraulic Variables using a 90-ft Long Bridge Deck for a 500-Year Flood Event**

Flow Obstructed by the Abutment (cfs)		Froude Number		Average Depth of Flow in the Obstructed Area (ft)		Average Velocity of Flow in the Obstructed Area (ft/s)	
Left	Right	Left	Right	Left	Right	Left	Right
1.0	1.0	0.3	0.4	0.5	0.4	1.3	1.4

The scour analysis of the proposed bridge designs indicate that contraction scour is not expected to be a concern. Simulating contraction scour using HEC-RAS for a 70-ft, 90-ft and 120-ft long bridge deck showed no contraction scour for any of the scenarios. Abutment scour was calculated using Froehlich’s Abutment Scour Equation (Arneson et al. 2012) for both left and right abutment for the 100- and 500-year flood event. Using a 120-ft long bridge deck, no abutment scour was computed. Using a 90-ft long bridge deck,

abutment scour of 3.7 ft was calculated for a 500-year flood event. No abutment scour is expected for a 100-year flood event using a 90-ft long bridge deck. Abutment scour using a 70-ft long bridge was calculated to be 3.0 ft and 4.7 ft for the 100- and 500-year flood event, respectively.

Long-term degradation of the channel was calculated to be 3.2 ft and 3.9 ft for a 100- and 500-year flood event, respectively. The scour depths were calculated by taking an average of natural channel scour calculated using equations based on regime theory developed by Lacey, Blench, Neill and the Bureau of Reclamation (Bureau of Reclamation 1984).

### **OVERTOPPING FLOOD**

The predicted water surface elevations of the existing Little Goldstream Creek Bridge No. 678 at the 1% and 0.2% annual chance exceedance flow are 391.4 ft and 392.5 ft respectively. The elevation of the low chord of the bridge is 393.9 ft. Therefore, no pressure/weir flow is expected to occur for all flow values higher than the 1% annual chance exceedance flow.

The proposed bridge geometry with a span of 120' results in a WSE of 392.1 ft. Although the widened span of the bridge does not decrease the estimated 1% chance exceedance flow WSE significantly, the abutment scour is reduced to 0.0 ft.

### **RIP RAP**

Riprap or other bank stabilization is recommended to provide protection from bank erosion. While abutment scour is not anticipated based on the current configuration, long term scour is estimated to be 3.2 ft. Little Goldstream Creek is a low gradient meandering stream with potential for bank migration. Bank protection can protect against the erosive forces that could result from the combination of long term scour and bank migration.

### **23 CODE OF FEDERAL REGULATIONS**

The 23 Code of Federal Regulations (23 CFR), part 650.111, "Location Hydraulic Studies," relates to the location of structures relative to the floodplain. Regarding this criteria of minimizing impact to the floodplain, the current Little Goldstream Creek Bridge is optimally located to reduce impacts to the overbank flow. While the channel capacity is limited and flow conveyed in the floodplain will be affected by the bridge, there is little room for adjustment in the crossing location. To alter the crossing would involve channel relocation resulting in more floodplain impacts than leaving the crossing at the current location.

### **FLOOD HAZARD AREA**

This project does not fall within a mapped flood hazard area based on the Federal Emergency Management Agency National Flood Insurance Program.

## 6. REFERENCES

---

- Alaska Department of Fish & Wildlife (ADF&G). 1987. Water Quality and Aquatic Habitat Assessments of Goldstream Creek Drainage. Technical Report 87-3. P.K. Weber and M.H. Robus. September 1987.
- Alaska Department of Transportation & Public Facilities (DOT&PF). 2013. Alaska Highway Preconstruction Manual. November 15, 2013.
- \_\_\_\_\_. 2012. Routine Inspection Report, Br No 678 Little Goldstream Ck. July 26, 2012.
- \_\_\_\_\_. 2006. Alaska Highway Drainage Manual
- \_\_\_\_\_. 1999. Bridge 678 Little Goldstream Creek Phase 1.5 Analysis.
- Arneson, L.A., Zevenbergen, L.W., Lagasse, P.F., Clopper, P.E., 2012, "Evaluating Scour at Bridges," Hydraulic Engineering Circular 18, Fifth Edition, FHWA NHI 01-001, Federal Highway Administration, U.S. Department of Transportation, Washington, D.C.
- Bureau of Reclamation (1984), "Computing Degradation and Local Scour."
- Design Alaska, Inc. 2015. Parks Highway MP 305-325 Reconstruction Survey Memo. W. Kinne. December 18, 2015.
- Location Hydraulic Studies. 650.111 23 CFR,  
2011.
- Michael Baker International. 2016. Wetland and Functional Assessment Report, Parks Highway MP 305-325 Reconstruction, Document No. 148830-MBI-WL-RPT. January 29, 2016.
- U.S. Army Corps of Engineers (USACE). 2010. Hydrologic Engineering Center, HEC-RAS, River Analysis Software, Version 4.1, Davis County, California, January 2010.
- U.S. Department of Commerce (USDC). 1958. Plan and Profile Proposed Highway Project, Fairbanks Nenana Grading & Drainage, Project No. F-037-I (5). Bureau of Public Roads. March 7, 1958.
- U.S. Geological Survey. 2015. National Hydrography Dataset. <http://nhd.usgs.gov>. Accessed October, 2015.
- \_\_\_\_\_. 1994. Magnitude and Frequency of Floods in Alaska and Conterminous Sheds of Canada. S.H. Jones and C.B. Fahl. USGS in cooperation with the State of Alaska, Department of Transportation and Public Facilities and Federal Highway Administration.
- \_\_\_\_\_. 2003. Estimating Annual High-flow Statistics and Monthly and Seasonal Low-Flow Statistics for Ungaged Sites on Streams in Alaska and Conterminos Basins in Canada. Curran, J.H., Wiley, J.B. United States Geological Survey Water-Resources Investigation Report -3=4114, 2003.
- \_\_\_\_\_. 2004. Summary and Comparison of Multiphase Streambed Scour Analysis at Selected Bridge Sites in Alaska. J. Conway. Scientific Investigations Report 2004-5066. USGS in cooperation with the State of Alaska, Department of Transportation and Public Facilities.
- \_\_\_\_\_. 1994. Hydrologic Unit Maps. P.R. Seaber, F.P. Kapinos, G.L. Knapp. United States Geological Survey Water-Supply Paper 2294.

## **Appendix A. Little Goldstream Creek Bridge No. 678 As-Builts**







**Appendix B. HEC-RAS Output Data for Little Goldstream Creek Bridge No.  
678**

Bridge\_Deck\_Adjustm.rep

HEC-RAS Version 4.1.0 Jan 2010  
U.S. Army Corps of Engineers  
Hydrologic Engineering Center  
609 Second Street  
Davis, California

```
X      X  XXXXXX      XXXX      XXXX      XX      XXXX
X      X  X          X      X      X  X      X
X      X  X          X          X  X      X  X      X
XXXXXXXX XXXX      X          XXX XXXX      XXXXXX      XXXX
X      X  X          X          X  X      X  X          X
X      X  X          X      X      X  X      X  X      X
X      X  XXXXXX      XXXX      X  X      X  X      XXXXXX
```

PROJECT DATA

Project Title: Bridge\_Deck\_Adjustment  
Project File : Bridge\_Deck\_Adjustm.prj  
Run Date and Time: 3/4/2016 4:54:17 PM

Project in English units

Project Description:  
ADOT&PF Parks Highway MP 305-325 Reconstruction  
Project 148830

Survey

points were collected between September 9, 2015 and November 19, 2015 by Design Alaska, Inc. and managed by William Kinne, PLS. All work was conducted with RTK GPS. Coordinates were translated to "Fairbanks 05-15-15". Elevations were calculated using the Geoid 12B model, NAVD88 datum. Two benchmarks set at the Little Goldstream Creek Bridge were established with differential levels from a primary control monument.

PLAN DATA

Plan Title: Final\_Deck\_70ft  
Plan File : t:\AKDOT\148830 - DOT&PF Parks 305-325 PI\03 Engineering\Hydrology and Hydraulics\HEC-RAS Model\HECRAS\030416\_Scour\_Analysi s\Bridge\_Deck\_Adjustm.p25

Geometry Title: Bridge\_Deck\_70ft  
Geometry File : t:\AKDOT\148830 - DOT&PF Parks 305-325 PI\03 Engineering\Hydrology and Hydraulics\HEC-RAS Model\HECRAS\030416\_Scour\_Analysi s\Bridge\_Deck\_Adjustm.g07

Flow Title : Steady\_USGS\_2003  
Flow File : t:\AKDOT\148830 - DOT&PF Parks 305-325 PI\03 Engineering\Hydrology and Hydraulics\HEC-RAS Model\HECRAS\030416\_Scour\_Analysi s\Bridge\_Deck\_Adjustm.f04

Plan Summary Information:

Number of:	Cross Sections	=	9	Multiple Openings	=	0
	Culverts	=	0	Inline Structures	=	0
	Bridges	=	1	Lateral Structures	=	0

Bridge\_Deck\_Adjustm.rep

Computational Information

Water surface calculation tolerance = 0.01  
Critical depth calculation tolerance = 0.01  
Maximum number of iterations = 20  
Maximum difference tolerance = 0.3  
Flow tolerance factor = 0.001

Computation Options

Critical depth computed only where necessary  
Conveyance Calculation Method: At breaks in n values only  
Friction Slope Method: Average Conveyance  
Computational Flow Regime: Subcritical Flow

FLOW DATA

Flow Title: Steady\_USGS\_2003

Flow File : t:\AKDOT\148830 - DOT&PF Parks 305-325 PI\03 Engineering\Hydrology and Hydraulics\HEC-RAS Model\HECRAS\030416\_Scour\_Analyses\Bridge\_Deck\_Adjustm.f04

Flow Data (cfs)

River	Reach	RS	Q100	Q500
Little Goldstream	Stream Centerline	640.59	1555	2162

Boundary Conditions

River	Reach	Profile	Upstream
Downstream			

Little Goldstream Centerline Q100

Normal S = 0.0005

Little Goldstream Centerline Q500

Normal S = 0.0005

GEOMETRY DATA

Geometry Title: Bridge\_Deck\_70ft

Geometry File : t:\AKDOT\148830 - DOT&PF Parks 305-325 PI\03 Engineering\Hydrology and Hydraulics\HEC-RAS Model\HECRAS\030416\_Scour\_Analyses\Bridge\_Deck\_Adjustm.g07

CROSS SECTION

RIVER: Little Goldstream  
REACH: Stream Centerline RS: 640.59

INPUT

Description: Most Upstream Cross Section

Station	Elevation	Data	num=	251	Station	Elevation	Station	Elevation	Station	Elevation
0	393.051	580017	392.94	6.01001	393.096	679993	393.0411	41003	393.17	
15.91003	393.2816	58002	393.2621	23004	393.3722	28003	393.3826	96002	393.49	

Bridge\_Deck\_Adjustm. rep

31.48999	393.6	35.87	393.737	66003	393.6942	05005	393.7949	92999	393.96
50.42004	393.9552	96002	393.956	98004	393.85	61.13	393.865	42004	393.74
67.61005	393.83	71.75	393.76	76.06	393.6980	53003	393.62	81.44	393.55
86.13	393.4987	07001	393.4391	67004	393.3792	53003	393.35	101.45	393.24
107.59	393.98	107.89	393.98	107.91	393.98	108.41	393.93	108.79	393.9
123.93	392.54	124.69	392.52	125.07	392.51	132.31	392.3	133.46	392.27
137.74	392.17	140.36	392.1	143.04	392.04	145.37	392.14	151.24	392.86
155.12	393.25	156.32	393.37	159.26	393.7	162.89	393.64	165.44	393.77
173.62	393.14	175.87	393.2	177.88	393.26	185.58	394.32	186.33	394.35
186.99	394.38	193.59	394.91	194.51	394.98	197.85	395.16	203.88	395.39
206.51	395.49	210.97	395.66	215.07	395.68	216.58	395.74	222.32	395.78
223.39	395.79	230.75	395.7	236.71	395.63	237.75	395.55	241.72	395.5
249.68	395.42	249.94	395.42	250.05	395.42	250.31	395.42	250.69	395.42
250.83	395.42	252.75	395.39	253.29	395.44	257.97	395.38	262.78	395.31
267.71	395.24	272.78	395.17	272.79	395.18	281.73	396.64	283.32	396.48
286.74	396.39	287.31	396.41	291.18	395.71	297.17	394.47	297.4	394.5
298.32	394.5	307.48	393.43	309.89	393.35	317.56	393.62	321.47	393.38
327.65	393.28	333.04	393.03	337.73	392.97	341.35	392.31	347.93	391.53
350.96	391.29	351.69	391.37	353.08	391.21	358.44	390.62	361.03	390.32
361.34	390.3	375.39	383.74	379.38	383.3	385.48	383	392.2	382.67
396.36	384.07	414.75	395.89	415.47	396.29	415.56	396.32	421.95	396.59
422.96	396.64	424.32	396.7	428.36	396.93	431.42	397.01	436.65	396.81
442.67	396.82	442.74	396.82	442.84	396.82	447.47	396.61	449.9	396.53
452.8	396.52	453.68	396.48	457.9	396.48	462.57	396.48	462.66	396.48
467.25	396.39	471.24	396.32	472.91	396.08	473.45	396.04	477.99	395.85
478.87	395.78	483.05	395.59	484.32	395.47	489.85	395.35	491.29	395.19
492.26	395.07	500.67	393.99	503.9	393.83	508.02	393.63	513.96	393.22
515.35	393.2	520.29	393.135	22.0601	393.11	525.78	393.1	531	393.03
533.39	393.2	538.08	393.55	539.04	393.58	542.75	393.9	543.49	393.9
544.72	393.91	544.82	393.92	552.96	393.8	553.28	393.81	553.84	393.83
561.78	394.045	561.9401	394.09	563.01	394.19	563.79	394.17	570.23	394.47
573.74	394.655	576.1901	394.785	578.8101	394.91	587.9	395.11	588.65	395.14
589.88	395.17	591.02	395.07	595.3	394.85	601.29	394.91	606.7	394.85
612.24	394.75	616.66	394.77	619.98	394.78	629	394.87	632.74	394.88
639.6901	395.08	639.7	395.08	639.72	395.08	652.72	395.18	653.12	395.18
653.75	395.16	654.39	395.14	655.24	395.1656	4301	395.06	664.58	394.48
668.14	394.39	673.1	394.24	676.56	394.16	680.9	394.07	682.89	394.03
686.85	393.93	687.63	393.91	692.45	393.81	698.16	393.69	703.58	394.18
703.75	394.18	703.95	394.18	710.86	393.75	716.36	393.67	717.98	393.61
720.02	393.53	725.1	393.42	729.14	393.09	732.21	392.99	736.09	392.97
739.33	393.02	741.91	393.12	746.45	393.26	752.15	393.14	754.49	393.15
754.63	393.15	755.65	393.19	760.47	393.35	767.3	393.58	777.03	394.13
779.6801	394.28	780.66	394.33	784.28	394.68	789.15	395.36	793.02	395.39
796.27	395.68	804.23	396.37	813.48	397.14	818.06	397.46	829.8	398.28
830.63	398.34	831.27	398.36	831.47	398.37	832.48	398.44	838.97	398.48
853.67	399.34	853.69	399.34	853.76	399.36	857.47	400.14	876.5	404.24
879.94	405.49	888.79	408.81	895.23	410.46	895.9	410.61	896.74	410.83
903.02	412.37	908.01	413.44	910.14	413.79	921.28	414.64	922.67	414.77
927.27	414.84								

Manning's n Values  
 Sta n Val Sta num= 3  
 0 .055 361.34 n Val Sta n Val  
 .035 415.56 .055

Bank Sta: Left Right Lengths: Left Channel Right Coeff Contr. Expan.  
 361.34 415.56 57.54 57.54 57.54 .1 .3  
 Left Levee Station= 281.73 El evati on= 396.641  
 Right Levee Station= 431.42 El evati on= 397.01

CROSS SECTION

RIVER: Little Goldstrea

REACH: Stream Centerlin

RS: 583.05

INPUT

Description: Upstream

Station Elevation Data

num= 246

Sta	Elev	Sta	Elev	Sta	Elev	Sta	Elev	Sta	Elev
0	392.821	390015	392.78	2.01001	392.776	530029	392.896	790039	392.89
11.46002	393.0211	79999	393.0216	59003	393.1616	82001	393.1621	70001	393.29
21.94	393.326	85004	393.4426	85999	393.4426	90002	393.44	29.37	393.51
31.85999	393.5736	72003	393.6837	09003	393.6842	01001	393.7850	82001	393.98
51.37	393.9752	46002	393.9557	01001	393.8961	71002	393.8366	54999	393.76
67.10004	393.7871	85999	393.7176	79004	393.63	78.56	393.681	79004	393.54
81.84003	393.54	86.75	393.4486	89001	393.4491	72003	393.3591	92999	393.36
101.29	393.19	101.65	393.19	102.01	393.2	107.8	393.86	107.95	393.86
108.67	393.86	123.9	392.52	124.26	392.52	125.5	392.54	131.12	392.38
132.5	392.35	135.62	392.27	139.79	392.16	144.02	392.06	144.84	392.1
146.92	392.35	153.61	393.02	155.67	393.23	160.69	393.79	163.48	393.75
165.44	393.85	174.76	393.13	176.6	393.18	178.25	393.23	186.81	394.41
187.06	394.42	187.28	394.43	189.79	394.63	193.72	394.8	194.24	394.81
195.38	394.92	199.24	395.12	204.5	395.33	206.81	395.42	210.7	395.56
215.96	395.6	217.31	395.64	222.43	395.68	223.38	395.69	229.97	395.61
235.31	395.55	237.23	395.4	241	395.36	248.56	395.28	249.14	395.29
249.41	395.29	250	395.28	250.88	395.28	251.19	395.27	253.01	395.25
254.3	395.37	258.64	395.31	263.09	395.25	267.66	395.19	272.36	395.12
273.36	395.13	275.06	395.8	280.68	396.72	285.63	396.2	289.67	396.24
292.74	395.73	296.52	395.19	302.57	394.47	306.96	394.36	312.35	394.1
314.07	393.93	315.46	393.89	321.17	393.79	328.18	392.64	328.28	392.63
328.36	392.63	335.39	392.33	348.03	390.48	348.74	390.38	358.55	385.54
371.67	383.49	374.89	382.99	377.23	384.78	388.97	390.12	391.57	390.71
393.79	391.2	397.64	392.07	400.03	392.61	402.26	393.11	403.81	393.45
407.51	393.8	410.15	394.13	414.79	394.62	417.26	394.9	419.69	395.16
425.95	395.88	425.96	395.89	425.98	395.89	430.28	396.05	441.56	396.47
444.92	396.48	447.05	396.4	449.49	396.39	451.91	396.28	455.17	396.28
458.84	396.28	463.02	396.28	465.37	396.3	469.41	396.3	474.02	396.29
474.46	396.27	476.78	396.28	479.13	396.18	479.27	396.17	486.55	396.02
486.79	395.99	486.95	395.97	499.36	394.38	500.62	394.32	502.22	394.24
512.62	393.53	513.33	393.52	515.89	393.48	516.8	393.47	525.01	393.45
528.14	393.4	529.57	393.51	532.37	393.72	538.19	393.89	541.1	394.14
541.94	394.21	547.74	394.2	551.73	394.4	551.98	394.4	558.02	394.44
558.88	394.52	563.32	394.43	568.04	394.65	574.51	394.98	575.76	395.04
577.1	395.11	583.53	395.26	586.22	395.25	588.37	395.26	592.34	395.06
595.87	395.09	604.63	394.99	613.65	394.83	614.4	394.84	614.96	394.84
627.5601	394.97	628.97	394.97	631.59	395.04	636.03	395.19	639.58	395.17
647.6	395.26	650.26	395.26	652.38	395.11659	4301	394.61	661.49	394.55
670.21	394.29	672.42	394.24	675.19	394.18	681.31	394.08	684.02	394.01
687.5	393.92	694.97	393.73	695.2	393.72	695.35	393.73	695.96	393.72
703.58	393.95	707.18	393.72	711.67	393.66	714.29	393.61	716.38	393.69
721.41	393.58	727.69	393.06	728.52	392.98	729.18	392.98	735.64	393.08
741.99	393.33	742.75	393.35	743.71	393.33	753.93	393.36	754.54	393.38
759.01	393.54	761.93	393.64	767.86	393.97	778.33	394.65	780.39	394.9
785.44	395.61	791.76	395.67	792.56	395.69	793.19	395.71	799.23	396.17
809.43	397.01	818.61	397.66	823.8	398.02	828.13	398.19	831.59	398.26
835.25	398.29	842.25	398.69	851.87	399.32	867.32	402.74	873.51	404.24
878.53	406.15	885.05	408.6	887.87	409.32	892.17	410.36	895.6	411.33
899.28	412.23	903.89	413.22	906.4	413.68	911.35	414.17	917.98	414.65
924.64	414.75								

Manning's n Values

num= 3

Sta	n Val	Sta	n Val	Sta	n Val
0	.055	348.74	.035	388.97	.055

Bank Sta: Left 348.74 Right 388.97 Lengths: Left Channel 55.95 Right Channel 55.95 Coeff Contr. .1 Expan. .3

Bridge\_Deck\_Adjustm.rep

Left Levee Station= 280.68 Elevation= 396.72  
 Right Levee Station= 441.56 Elevation= 396.47

CROSS SECTION

RIVER: Little Goldstream  
 REACH: Stream Centerline RS: 527.1

INPUT

Description: Upstream

Station	Elevation	Data	num=	239	Station	Elevation	Station	Elevation	Station	Elevation	
0	391.45	.0999			391.457	809998	391.629	019958	391.622	17999	391.91
22.77997	391.92	34.31			391.893	6.23999	391.89	39.94	391.474	6.84998	391.46
54.87	391.42	60.32996			391.416	9.78998	391.467	3.79999	391.688	4.70996	392.22
86.38995	392.23	99.88			392.57	100.22	392.57	100.59	392.58	111.14	392.58
114.28	392.61	114.33			392.61	114.38	392.61	114.44	392.61	128.09	392.98
128.35	392.98	129.47			392.92	141.17	393.36	144.4	393.68	151.21	394.18
153.65	394.39	153.69			394.39	159.04	394.95	160.67	395.15	167.11	395.49
167.3	395.5	169.05			395.61	173.15	395.74	176.41	395.69	176.67	395.68
179.37	395.64	183.48			395.52	188.7	395.52	188.72	395.52	188.74	395.54
190.99	395.56	192.38			395.56	198.3	395.55	200.17	395.52	202.96	395.49
207.21	395.44	211.24			395.4	213.78	395.36	218.74	395.3	220.99	395.16
224.75	394.94	230.15			395.01	233.55	394.84	234.3	394.57	236.53	394.45
236.93	394.42	240.18			394.31	243.62	394.09	245.8199	394.01	247.95	393.87
249.62	393.81	253.13			393.56	254.04	393.53	258.3	393.21	259.18	393.15
261.45	393.11	261.99			393.11	268.3	393.03	273.88	392.95	276.61	392.96
278.3	392.8	287.71			392.93	289.75	392.8	290.81	392.85	291.64	392.89
292.3	392.93	304.0699			392.83	305	392.87	308.53	393	312.34	393.11
314.54	393.12	321.6			393.22	322.59	393.22	330.87	393.23	331.61	393.23
333.29	393.22	341.62			393.23	343.23	393.23	351.63	393.24	353.17	393.23
361.63	393.24	363.11			393.24	371.64	393.25	373.16	393.25	376.72	392.81
376.95	392.83	376.99			392.84	383.02	394.52	383.22	394.4	386.35	392.53
387.5699	391.8	388.52			391.22	391.12	389.67	392.7599	388.69	393.12	388.47
401.17	383.86	402.25			382.52	405.79	382.69	413.0099	385.11	413.17	385.16
413.56	385.28	414.35			385.53	414.83	385.69	415.85	386.01	416.47	386.21
417.83	386.64	418.66			386.91	419.54	387.19	424.26	388.7	425	388.93
425.34	389.04	428.18			389.95	428.59	390.06	434.99	391.89	443.33	392.7
445.34	392.89	455.57			393.85	460.69	394.04	471.07	394.59	473.3	394.51
481.09	394.65	482.79			394.66	491.1	394.82	500.4	394.92	501.16	394.94
501.21	394.94	501.57			394.94	502	394.94	514.89	395.15	517.12	395.17
517.39	395.17	527.37			395.29	530.65	395.35	532.97	395.39	540.05	395.55
542.64	395.59	545.72			395.64	549.4299	395.7	553.17	395.72	556.85	395.79
561.27	395.87	565.67			395.95	566.4399	395.95	566.66	395.95	571.86	395.96
578.27	395.96	580.05			395.96	583.48	395.97	590.85	395.95	598.1899	395.92
602.09	396.05	608.72			396.03	611.38	395.93	619.12	395.9	622.5	395.99
629.76	395.96	634.24			396	637.99	395.99	640.64	395.96	643.25	395.94
650.66	395.67	652.8099			395.63	654.5599	395.6	656.01	395.58	667.02	395.55
667.63	395.54	668.14			395.53	674.0599	395.25	680.73	394.81	682.1	394.83
684.18	394.75	692.7			394.66	696.54	394.6	702.36	394.32	704.67	394.21
710.97	394	716.65			393.82	718.1899	393.82	720.54	393.75	725.41	393.6
728.62	393.53	732.63			393.46	738.72	393.32	739.85	393.3	740.86	393.29
741.46	393.3	751.49			393.43	754.1899	393.5	759.96	393.65	760.53	393.71
775.95	395.12	776.52			395.18	783.17	395.84	788.5	396.16	793.25	396.59
797.6	396.92	800.47			397.09	804.8199	397.05	810.93	397.15	815.89	396.99
822.27	397.73	826.48			398.13	829.61	397.93	833.7	397.74	836.39	397.91
840.92	398.33	847.79			398.55	848.14	398.55	848.37	398.56	860.96	399.22
862.52	399.27	877			403.05	881.2599	404.24	886.05	405.79	896.27	409.31
898.67	409.9	902.33			410.94	905.89	411.86	908.24	412.37	913.11	413.28
920.97	414.09	924.88			414.57	930.7599	414.66	931.6	414.67		

Manning's n Values

num= 3

Bridge\_Deck\_Adjustm.rep

Sta n Val Sta n Val Sta n Val  
 0 .055 386.35 .035 428.18 .046

Bank Sta: Left Right Lengths: Left Channel Right Coeff Contr. Expan.  
 386.35 428.18 272.34 272.34 272.34 .2 .4  
 Left Levee Station= 173.15 Elevation= 395.74  
 Right Levee Station= 608.72 Elevation= 396.03

CROSS SECTION

RIVER: Little Goldstrea  
 REACH: Stream Centerlin RS: 497.46

INPUT

Description: Upstream of Proposed Bridge  
 Station Elevation Data num= 201

Sta	Elev	Sta	Elev	Sta	Elev	Sta	Elev	Sta	Elev
0	393.73	8.43	393.5	8.59	393.5	8.72	393.5	8.84	393.5
8.96	393.49	11.96	393.39	22.02	393.24	24.2	393.24	34.97	393.5
39.95	393.57	44.6	394.05	45.76	394.05	57.22	393.75	58.22	393.74
58.86	393.74	60.46	393.75	72.57	393.71	73.36	393.71	84.66	393.6
86.87	393.6	86.94	393.6	87.01	393.6	100.18	393.54	100.66	393.55
101.14	393.55	101.64	393.55	113.78	393.76	114.62	393.76	118.7	393.88
122.12	394.18	124.04	394.2	135.94	394.03	136.97	394.03	137.17	394.03
150.47	393.85	150.88	393.85	151.3	393.85	157.36	393.91	164.88	394.04
165.46	394.04	178.1	394.27	179.61	394.28	190.7	394.33	192.99	394.33
195.4	394.34	205.28	394.56	211.08	394.57	215.21	394.58	221.1	394.59
225.14	394.6	231.13	394.61	241.9	394.77	243.04	394.77	244.25	394.77
256.11	394.7	256.55	394.7	258.37	394.7	268.52	394.76	271.61	394.77
274.75	394.77	281.21	394.63	284.87	394.62	291.22	394.63	294.85	394.62
301.22	394.62	304.83	394.61	311.23	394.62	312.36	394.61	314.42	394.61
320.86	394.62	331.73	394.64	334.48	394.64	337.28	394.65	346.85	394.79
350.45	394.8	351.32	394.8	354.04	394.79	361.46	394.63	364.29	394.61
370.92	394.6	372.61	394.59	374.3	394.58	380.91	394.56	382.61	394.55
384.32	394.55	395.63	394.1	397.82	394.09	399.97	394.09	410.08	394.39
413.09	394.38	416.03	394.37	425	390	457.62	390	480	382.54
490	382.54	512.38	390	545	390	546.58	393.23	548.87	393.78
550.07	393.79	550.4	393.79	559.53	393.79	561.33	393.78	566.8	393.78
612.68	393.77	615.89	393.78	622.63	393.77	625.89	393.78	632.57	393.77
635.9	393.78	637.37	393.78	643.99	393.77	645.9	393.77	651.57	393.69
655.31	393.67	661.72	393.48	661.93	393.47	661.98	393.47	665.36	393.49
675.62	393.56	676.06	393.56	676.48	393.56	688.59	393.38	689.98	393.52
694.01	393.5	698.6	393.56	703.81	393.63	706	393.62	708.57	393.66
713.3	393.75	713.76	393.75	715.24	393.78	718.13	393.98	718.64	394
721.56	394.19	722.61	394.23	727.52	394.54	729.37	394.6	729.97	394.64
731.26	394.71	732.42	395.12	734.65	395.24	743.52	395.11	746.53	395.3
748.33	395.41	752.31	395.45	757.2	395.53	760.39	395.57	763.75	395.6
765.96	395.63	770.46	395.7	775.08	395.7	776.16	395.71	781.18	395.67
781.24	395.63	781.27	395.61	785.95	395.62	794.71	395.86	795.26	395.87
795.31	395.87	795.98	395.88	796.81	395.85	797.17	395.83	797.21	395.83
799.26	395.72	808.48	395.26	811.9	394.9	811.96	394.89	815.55	394.59
823.44	394.01	824.14	393.96	824.18	393.96	824.6	393.94	824.89	393.94
837.49	393.43	838.69	393.41	839.8	393.4	852.13	393.13	853.65	393.11
865.29	393.09	867.18	393.07	868.95	393.05	880.44	392.76	885.11	392.73
891.47	392.41	900	391.94	904.96	391.91	914.9	391.94	918.45	391.95
929.79	391.97	931.01	392.11	931.64	392.11	945.02	392.14	945.25	392.14
952.78	391.96	958.99	391.85	959.19	391.85	959.39	391.85	959.44	391.85
967.8	391.75								

Manning's n Values num= 3  
 Sta n Val Sta n Val Sta n Val  
 0 .046 416.03 .035 548.87 .046



Bridge\_Deck\_Adjustm.rep

Bank Sta: Left Right Lengths: Left Channel Right Coeff Contr. Expan.  
 416.03 548.87 63.41 63.41 63.41 .3 .5

BRIDGE

RIVER: Little Goldstrea  
 REACH: Stream Centerlin RS: 450

INPUT

Description: Little Goldstream Bridge - Proposed  
 Distance from Upstream XS = 5  
 Deck/Roadway Width = 56  
 Weir Coefficient = 2.6

Upstream Deck/Roadway Coordinates  
 num= 6

Sta	Hi	Cord	Lo	Cord	Sta	Hi	Cord	Lo	Cord	Sta	Hi	Cord	Lo	Cord
331.73	394.64	0	450	396.11	0	450	396.11	395.15						
520	396.11	395.15	520	396.11	0	734.65	395.24	0						

Upstream Bridge Cross Section Data

Station Elevation Data num= 201

Sta	Elev	Sta	Elev	Sta	Elev	Sta	Elev	Sta	Elev
0	393.73	8.43	393.5	8.59	393.5	8.72	393.5	8.84	393.5
8.96	393.49	11.96	393.39	22.02	393.24	24.2	393.24	34.97	393.5
39.95	393.57	44.6	394.05	45.76	394.05	57.22	393.75	58.22	393.74
58.86	393.74	60.46	393.75	72.57	393.71	73.36	393.71	84.66	393.6
86.87	393.6	86.94	393.6	87.01	393.6	100.18	393.54	100.66	393.55
101.14	393.55	101.64	393.55	113.78	393.76	114.62	393.76	118.7	393.88
122.12	394.18	124.04	394.2	135.94	394.03	136.97	394.03	137.17	394.03
150.47	393.85	150.88	393.85	151.3	393.85	157.36	393.91	164.88	394.04
165.46	394.04	178.1	394.27	179.61	394.28	190.7	394.33	192.99	394.33
195.4	394.34	205.28	394.56	211.08	394.57	215.21	394.58	221.1	394.59
225.14	394.6	231.13	394.61	241.9	394.77	243.04	394.77	244.25	394.77
256.11	394.7	256.55	394.7	258.37	394.7	268.52	394.76	271.61	394.77
274.75	394.77	281.21	394.63	284.87	394.62	291.22	394.63	294.85	394.62
301.22	394.62	304.83	394.61	311.23	394.62	312.36	394.61	314.42	394.61
320.86	394.62	331.73	394.64	334.48	394.64	337.28	394.65	346.85	394.79
350.45	394.8	351.32	394.8	354.04	394.79	361.46	394.63	364.29	394.61
370.92	394.6	372.61	394.59	374.3	394.58	380.91	394.56	382.61	394.55
384.32	394.55	395.63	394.1	397.82	394.09	399.97	394.09	410.08	394.39
413.09	394.38	416.03	394.37	425	390	450	390	480	382.54
490	382.54	520	390	545	390	546.58	393.23	548.87	393.78
550.07	393.79	550.4	393.79	559.53	393.79	561.33	393.78	566.8	393.78
612.68	393.77	615.89	393.78	622.63	393.77	625.89	393.78	632.57	393.77
635.9	393.78	637.37	393.78	643.99	393.77	645.9	393.77	651.57	393.69
655.31	393.67	661.72	393.48	661.93	393.47	661.98	393.47	665.36	393.49
675.62	393.56	676.06	393.56	676.48	393.56	688.59	393.38	689.98	393.52
694.01	393.5	698.6	393.56	703.81	393.63	706	393.62	708.57	393.66
713.3	393.75	713.76	393.75	715.24	393.78	718.13	393.98	718.64	394
721.56	394.19	722.61	394.23	727.52	394.54	729.37	394.6	729.97	394.64
731.26	394.71	732.42	395.12	734.65	395.24	743.52	395.11	746.53	395.3
748.33	395.41	752.31	395.45	757.2	395.53	760.39	395.57	763.75	395.6
765.96	395.63	770.46	395.7	775.08	395.7	776.16	395.71	781.18	395.67
781.24	395.63	781.27	395.61	785.95	395.62	794.71	395.86	795.26	395.87
795.31	395.87	795.98	395.88	796.81	395.85	797.17	395.83	797.21	395.83
799.26	395.72	808.48	395.26	811.9	394.9	811.96	394.89	815.55	394.59
823.44	394.01	824.14	393.96	824.18	393.96	824.6	393.94	824.89	393.94
837.49	393.43	838.69	393.41	839.8	393.4	852.13	393.13	853.65	393.11
865.29	393.09	867.18	393.07	868.95	393.05	880.44	392.76	885.11	392.73
891.47	392.41	900	391.94	904.96	391.91	914.9	391.94	918.45	391.95
929.79	391.97	931.01	392.11	931.64	392.11	945.02	392.14	945.25	392.14

Bridge\_Deck\_Adjustm.rep

952.78 391.96 958.99 391.85 959.19 391.85 959.39 391.85 959.44 391.85  
 967.8 391.75

Manning's n Values num= 3  
 Station Val Sta n Val Sta n Val  
 0 .046 416.03 .035 548.87 .046

Bank Sta: Left Right Coeff Contr. Expan.  
 416.03 548.87 .3 .5

Downstream Deck/Roadway Coordinates

num= 6  
 Sta Hi Cord Lo Cord Sta Hi Cord Lo Cord Sta Hi Cord Lo Cord  
 150 393.96 0 325 396.11 0 325 396.11 395.15 0  
 395 396.11 395.15 395 396.11 0 558.41 394.56 395.15 0

Downstream Bridge Cross Section Data

Station Elevation Data num= 275  
 Sta Elev Sta Elev Sta Elev Sta Elev Sta Elev  
 0 395.47 .63 395.49 3.61 395.55 5.64 395.66 8.6 395.6  
 10.66 395.54 13.6 395.58 15.67 395.62 18.59 395.63 20.69 395.71  
 23.59 395.65 25.96 395.64 28.84 395.65 30.72 395.7 33.58 395.55  
 35.73 395.55 38.57 395.69 40.75 395.7 43.57 395.69 45.76 395.7  
 48.56 395.66 50.78 395.68 53.55 395.65 55.8 395.65 58.55 395.64  
 60.81 395.59 63.54 395.52 65.83 395.44 68.54 395.44 70.85 395.35  
 73.53 395.3 75.86 395.29 78.53 395.28 80.88 395.27 83.52 395.26  
 85.9 395.25 88.51 395.22 90.91 395.18 93.51 395.13 95.93 394.94  
 98.5 394.25 100.95 393.96 103.5 393.5 105.96 393.49 108.49 393.68  
 110.98 393.65 113.84 392.96 116.36 392.93 118.48 392.96 121 393.41  
 123.48 393.46 126.01 393.78 128.48 393.82 131.01 393.84 133.47 394.29  
 134 395.04 136.47 395.19 141.01 395.4 143.48 395.37 146 395.22  
 148.48 395.19 150.99 395.1 153.48 394.88 155.99 394.6 158.48 394.56  
 160.98 394.55 163.49 394.51 165.98 394.26 168.49 394.08 170.97 393.96  
 173.49 393.91 175.97 393.9 178.49 393.77 180.96 393.63 183.49 393.62  
 185.95 393.36 188.49 393.34 190.95 393.34 193.5 393.22 195.94 393.1  
 198.5 393.08 200.94 392.96 203.5 392.85 205.93 392.82 208.5 392.7  
 210.92 392.68 213.5 392.78 215.57 392.92 218.16 392.91 220.92 392.96  
 223.5 392.95 226.1 392.94 230.93 392.93 233.5 392.85 236.09 392.86  
 240.93 392.87 243.5 392.84 246.09 392.84 250.93 392.85 253.5 392.82  
 256.08 392.82 260.94 393.19 263.5 393.19 266.07 393.19 270.94 393.19  
 273.5 393.19 276.61 393.19 279.16 393.07 281.04 393.06 281.41 393.06  
 284.49 393.07 290.19 392.96 291.27 392.96 291.61 392.97 295.35 392.97  
 299.05 392.66 300 390 325 390 355 382 365 382  
 395 390 420 390 421.56 391.86 424.75 392 428.8 392.06  
 431.71 392.19 435.06 392.32 436.88 392.38 439.93 392.5 449.82 392.62  
 467.6 393.17 470.89 393.14 474.35 393.17 477.71 393.13 481.25 393.18  
 484.22 393.1 487.82 393.14 491.63 393.17 494.08 393.28 497.94 393.31  
 501.25 393.36 502.01 393.49 503.64 393.54 503.85 393.65 504.17 393.75  
 504.58 393.81 507.8 393.9 509.7 393.91 511.47 393.99 512.28 394.05  
 513.66 394.11 513.83 394.11 514.14 394.19 514.63 394.19 514.83 394.2  
 519.72 394.28 529.69 394.28 530.8 394.29 530.93 394.37 531.11 394.37  
 531.65 394.38 532.19 394.46 541.34 394.46 544.94 394.47 546.6 394.52  
 558.41 394.56 568.12 394.7 608.01 394.93 620.8 394.95 621.23 394.93  
 621.24 394.95 621.25 394.92 621.27 394.94 621.29 394.96 634.83 394.93  
 636.49 394.96 642.32 394.98 644.38 394.95 646.48 394.97 652.33 394.99  
 654.38 394.96 656.47 394.98 667.97 395 669.94 394.98 672 395  
 673.15 395.02 681.02 395 683.78 395.02 686.46 395.04 688.42 395.06  
 694.13 395.08 696.48 395.1 702.18 395.12 704.31 395.14 706.5 395.16  
 712.12 395.18 714.29 395.2 716.52 395.22 716.63 395.24 722.15 395.26  
 726.52 395.28 732.05 395.3 734.28 395.32 736.52 395.34 739.11 395.36  
 740 395.38 743.02 395.4 746.28 395.42 752.53 395.44 753.36 395.46  
 753.5 395.48 754.32 395.5 758.75 395.52 761.26 395.54 763.82 395.56  
 764.82 395.58 767.97 395.6 778.17 395.62 783.54 395.66 787.64 395.68

Bridge\_Deck\_Adjustm. rep

792.07	395.68	798	395.7	798.49	395.71	799.3	395.73	806	395.73
808.54	395.75	817.06	395.76	818.55	395.77	819.99	395.78	827.3	395.8
829	395.8	835.88	395.82	836.19	395.83	841.57	395.84	847.39	395.85
853.97	395.87	855.39	395.87	855.93	395.89	856.3	395.89	856.57	395.91
856.61	395.92	856.71	395.93	856.76	395.94	856.81	395.96	856.87	395.96
856.99	395.98	857.82	395.99	857.94	396	866.95	396.01	874.06	396.03
880.54	396.03	881.67	396.05	883.15	396.06	887.72	396.08	893.96	396.08
898.23	396.1	903.39	396.11	906.94	396.12	912.43	396.13	919.06	396.15
919.93	396.15	926.64	396.17	932.92	396.18	933.74	396.2	934.73	396.21
940.84	396.23	945.91	396.23	947.94	396.25	950.4	396.26	955.05	396.28
958.89	396.29	962.15	396.31	965.99	396.31	968.48	396.33	968.96	396.34

Manning's n Values num= 3  
 Sta n Val Sta n Val Sta n Val  
 0 .046 299.05 .035 421.56 .046

Bank Sta: Left Right Coeff Contr. Expan.  
 299.05 421.56 .3 .5

Upstream Embankment side slope = 0 horiz. to 1.0 vertical  
 Downstream Embankment side slope = 0 horiz. to 1.0 vertical  
 Maximum allowable submergence for weir flow = .98  
 Elevation at which weir flow begins =  
 Energy head used in spillway design =  
 Spillway height used in design =  
 Weir crest shape = Broad Crested

Number of Bridge Coefficient Sets = 1

Low Flow Methods and Data

Energy  
 Momentum Cd = 1.2  
 W. S. Pro Method

W. S. Pro Data

Left Embankment  
 El of the top of the embankment = 395.15  
 El of the toe of the abutment = 360  
 Right Embankment  
 El of the top of the embankment = 395.15  
 El of the toe of the abutment = 360  
 Abutment Type = 1 Vert. abutments and vert. embankments  
 with or without wingwalls  
 Slope of abutments =  
 Top width of embankment = 90  
 Centroid station of bridge opening =  
 Wing Wall Type = No wing walls present  
 Width =  
 Angle =  
 Radius =  
 Guide Banks Type = No Guide Bank present  
 Length =  
 Offset =  
 Angle =

Selected Low Flow Methods = Highest Energy Answer

High Flow Method  
 Energy Only

Additional Bridge Parameters

Add Friction component to Momentum  
 Do not add Weight component to Momentum

Bridge\_Deck\_Adjustm.rep  
 Class B flow critical depth computations use critical depth  
 inside the bridge at the upstream end  
 Criteria to check for pressure flow = Upstream energy grade line

CROSS SECTION

RIVER: Little Goldstrea  
 REACH: Stream Centerlin RS: 434.05

INPUT

Description: Downstream of Proposed Bridge  
 Station Elevation Data num= 275

Sta	Elev	Sta	Elev	Sta	Elev	Sta	Elev	Sta	Elev
0	395.47	.63	395.49	3.61	395.55	5.64	395.66	8.6	395.6
10.66	395.54	13.6	395.58	15.67	395.62	18.59	395.63	20.69	395.71
23.59	395.65	25.96	395.64	28.84	395.65	30.72	395.7	33.58	395.55
35.73	395.55	38.57	395.69	40.75	395.7	43.57	395.69	45.76	395.7
48.56	395.66	50.78	395.68	53.55	395.65	55.8	395.65	58.55	395.64
60.81	395.59	63.54	395.52	65.83	395.44	68.54	395.44	70.85	395.35
73.53	395.3	75.86	395.29	78.53	395.28	80.88	395.27	83.52	395.26
85.9	395.25	88.51	395.22	90.91	395.18	93.51	395.13	95.93	394.94
98.5	394.25	100.95	393.96	103.5	393.5	105.96	393.49	108.49	393.68
110.98	393.65	113.84	392.96	116.36	392.93	118.48	392.96	121	393.41
123.48	393.46	126.01	393.78	128.48	393.82	131.01	393.84	133.47	394.29
134	395.04	136.47	395.19	141.01	395.4	143.48	395.37	146	395.22
148.48	395.19	150.99	395.1	153.48	394.88	155.99	394.6	158.48	394.56
160.98	394.55	163.49	394.51	165.98	394.26	168.49	394.08	170.97	393.96
173.49	393.91	175.97	393.9	178.49	393.77	180.96	393.63	183.49	393.62
185.95	393.36	188.49	393.34	190.95	393.34	193.5	393.22	195.94	393.1
198.5	393.08	200.94	392.96	203.5	392.85	205.93	392.82	208.5	392.7
210.92	392.68	213.5	392.78	215.57	392.92	218.16	392.91	220.92	392.96
223.5	392.95	226.1	392.94	230.93	392.93	233.5	392.85	236.09	392.86
240.93	392.87	243.5	392.84	246.09	392.84	250.93	392.85	253.5	392.82
256.08	392.82	260.94	393.19	263.5	393.19	266.07	393.19	270.94	393.19
273.5	393.19	276.61	393.19	279.16	393.07	281.04	393.06	281.41	393.06
284.49	393.07	290.19	392.96	291.27	392.96	291.61	392.97	295.35	392.97
299.05	392.66	300	390	331	390	355	382	365	382
389	390	420	390	421.56	391.86	424.75	392	428.8	392.06
431.71	392.19	435.06	392.32	436.88	392.38	439.93	392.5	449.82	392.62
467.6	393.17	470.89	393.14	474.35	393.17	477.71	393.13	481.25	393.18
484.22	393.1	487.82	393.14	491.63	393.17	494.08	393.28	497.94	393.31
501.25	393.36	502.01	393.49	503.64	393.54	503.85	393.65	504.17	393.75
504.58	393.81	507.8	393.9	509.7	393.91	511.47	393.99	512.28	394.05
513.66	394.11	513.83	394.11	514.14	394.19	514.63	394.19	514.83	394.2
519.72	394.28	529.69	394.28	530.8	394.29	530.93	394.37	531.11	394.37
531.65	394.38	532.19	394.46	541.34	394.46	544.94	394.47	546.6	394.52
558.41	394.56	568.12	394.7	608.01	394.93	620.8	394.95	621.23	394.93
621.24	394.95	621.25	394.92	621.27	394.94	621.29	394.96	634.83	394.93
636.49	394.96	642.32	394.98	644.38	394.95	646.48	394.97	652.33	394.99
654.38	394.96	656.47	394.98	667.97	395	669.94	394.98	672	395
673.15	395.02	681.02	395	683.78	395.02	686.46	395.04	688.42	395.06
694.13	395.08	696.48	395.1	702.18	395.12	704.31	395.14	706.5	395.16
712.12	395.18	714.29	395.2	716.52	395.22	716.63	395.24	722.15	395.26
726.52	395.28	732.05	395.3	734.28	395.32	736.52	395.34	739.11	395.36
740	395.38	743.02	395.4	746.28	395.42	752.53	395.44	753.36	395.46
753.5	395.48	754.32	395.5	758.75	395.52	761.26	395.54	763.82	395.56
764.82	395.58	767.97	395.6	778.17	395.62	783.54	395.66	787.64	395.68
792.07	395.68	798	395.7	798.49	395.71	799.3	395.73	806	395.73
808.54	395.75	817.06	395.76	818.55	395.77	819.99	395.78	827.3	395.8
829	395.8	835.88	395.82	836.19	395.83	841.57	395.84	847.39	395.85
853.97	395.87	855.39	395.87	855.93	395.89	856.3	395.89	856.57	395.91
856.61	395.92	856.71	395.93	856.76	395.94	856.81	395.96	856.87	395.96

Bridge\_Deck\_Adjustm.rep

856.99	395.98	857.82	395.99	857.94	396	866.95	396.01	874.06	396.03
880.54	396.03	881.67	396.05	883.15	396.06	887.72	396.08	893.96	396.08
898.23	396.1	903.39	396.11	906.94	396.12	912.43	396.13	919.06	396.15
919.93	396.15	926.64	396.17	932.92	396.18	933.74	396.2	934.73	396.21
940.84	396.23	945.91	396.23	947.94	396.25	950.4	396.26	955.05	396.28
958.89	396.29	962.15	396.31	965.99	396.31	968.48	396.33	968.96	396.34

Manning's n Values			num=	3	
Sta	n Val	Sta	n Val	Sta	n Val
0	.046	299.05	.035	421.56	.046

Bank Sta:	Left	Right	Lengths:	Left Channel	Right	Coeff Contr.	Expan.
	299.05	421.56		60	60	.3	.5

CROSS SECTION

RIVER: Little Goldstrea  
 REACH: Stream Centerlin RS: 376.11

INPUT

Description: Downstream  
 Station Elevation Data

			num=	209					
Sta	Elev	Sta	Elev	Sta	Elev	Sta	Elev	Sta	Elev
0	3903.08	0017	390.187	869995	390.47	11.31	390.6716	08002	390.59
18.14001	390.5618	17004	390.5619	97003	390.6520	77002	390.7223	02002	390.72
25.37	390.69	29	390.6831	79999	390.6838	04004	390.6740	34003	390.66
52.20001	390.955	45001	390.9656	95001	390.98	58.37	391.0159	72003	391.03
70.65002	390.9371	47003	390.9472	23004	390.9572	96002	390.9685	71002	391.51
85.75	391.5185	78003	391.51	85.81	391.5199	04004	391.78	100.94	391.82
105.04	391.98	106.5	392.01	109.4	392.12	110.7	392.14	114.58	392.29
115.69	392.31	119.77	392.47	120.68	392.49	124.97	392.66	125.66	392.67
130.18	392.86	130.65	392.86	135.4	393.06	135.63	393.07	136.17	393.07
140.25	393.26	140.59	393.28	140.71	393.29	143.38	393.43	150.12	393.52
154.27	392.98	158.73	392.96	165.49	392.96	171.52	394.21	174.59	394.85
176.41	395.28	179.5	395.31	180.15	395.32	193.08	395.22	194.5	395.23
198.34	395.11	199.44	395.11	203.51	395.11	208.45	395.11	209.02	395.11
211.84	395.11	214.12	394.72	214.55	394.63	221.23	393.46	222.95	393.07
225.18	392.51	228.24	391.84	230.69	391.24	239.4	389.38	239.86	389.44
241.33	389.55	242.73	389.7	247.5	390.14	250.24	390.39	251.1	390.47
260.75	388.31	260.77	388.3	261.83	388	266.44	385.49	272.78	382.16
275.39	382.16	283	382.16	287.02	384.68	291.13	387.56	292.24	388.36
292.65	388.64	293.77	389.24	303.1	389.86	303.37	389.88	306.33	390.05
306.95	390.06	309.22	390.1	320.89	390.28	321.39	390.29	322.01	390.3
333.89	390.31	335.55	390.29	335.79	390.3	336.11	390.29	348.04	390.18
350.08	390.27	352.81	390.25	360.53	390.29	364.37	390.37	369.51	390.24
373.01	390.24	378.66	390.37	385.5	390.73	386.21	390.73	392.95	390.62
399.51	390.3	408.02	390.27	421.17	383.62	422.89	382.12	425.43	382.14
435.09	382.24	435.95	382.31	443.19	388.33	443.77	388.36	446.88	388.52
447.48	388.56	449.12	388.64	456.68	389.05	464.64	389.51	469.75	389.87
472.16	389.99	472.88	390.01	485.21	390.09	485.74	390.1	486.22	390.11
486.66	390.12	499.77	390.79	500	390.8	500.22	390.81513	4301	390.81
514.15	390.81	514.22	390.82	527.7	391.13	528.35	391.13528	5601	391.13
528.69	391.13	541.99	391.06	542.58	391.08	543.09	391.11	543.74	391.13
556.06	391.54	556.89	391.58	557.99	391.63	559.52	391.69566	1801	392.03
569.83	392.18	574.04	392.32	577.45	392.47	581.73	392.65	585.24	392.8
586.04	392.83	590.74	392.89	593	392.93	597.26	393	600.61	393.05
605.63	393.25	609.16	393.33	612.06	393.4	618.42	393.44	618.63	393.44
622.52	393.38	627.44	393.45	632.81	393.6	634.51	393.7636	1801	393.74
642.8	393.8	648.77	393.85	654.19	393.94	662.72	394.09	675.06	394.93
675.9	394.98	676.69	395.04	677.13	395.06	677.14	395.06	677.53	395.06
687.89	395.08	696.35	395.19	697.11	395.2	699.92	395.25	706.37	395.37
709.3	395.43	717.35	395.6	721.15	395.56	729.37	395.36	733.98	395.16

Bridge\_Deck\_Adjustm. rep

736.18	395.19	738.86	395.24	744.62	395.27	748.89	395.33	752.81	395.38
758.29	395.5	759.71	395.52	762.7	395.77	766.06	396.32	770.99	396.94
773.36	397.23	781.05	397.83	783.16	397.79	785.08	398		

Manning's n Values num= 3

Sta	n Val	Sta	n Val	Sta	n Val
0	.055	408.02	.035	443.19	.055

Bank Sta:	Left	Right	Lengths:	Left Channel	Right	Coeff	Contr.	Expan.
	408.02	443.19		58.59	58.59		.2	.4
Ineffective Flow	num= 1							
Sta L	Sta R	Elev	Permanent					
250.24	320.89	390.31	T					
Left Levee	Station=	179.5	Elevation=	395.31				

CROSS SECTION

RIVER: Little Goldstream  
 REACH: Stream Centerline RS: 317.52

INPUT

Description: Downstream  
 Station Elevation Data

	Sta	Elev	Sta	Elev	Sta	Elev	Sta	Elev	Sta	Elev
	0	390.050049	390.292	970032	390.3112	09003	390.714	14001	390.74	
16.	14001	390.7818	11005	390.8223	72003	390.9126	01001	390.9628	62006	391
31.	04004	391.0533	53003	391.0936	05005	391.1438	45001	391.1841	07001	391.24
43.	37006	391.2846	08002	391.3348	30005	391.3751	09003	391.4265	71002	391.77
65.	76001	391.7765	77002	391.7765	84003	391.7765	87006	391.7767	41003	391.76
79.	43005	391.7179	55005	391.7180	17004	391.7280	54004	391.7393	14001	391.95
93.	87006	391.9794	61005	391.9895	36005	391.9995	92004	392	103.29	392.3
	114.82	392.21	120.26	392.36	121.61	392.4128	8701	392.64132	4301	392.75
	142.4	393.03	145.1	393.08	157.73	393.24	158.29	393.23	161.7	393.18
	171.89	392.98	172.23	392.98	172.59	392.98	185.01	392.85	185.76	392.86
	186.57	392.86	187.4301	392.86	194.29	392.68	198.7401	392.54	201.86	392.6
	212.58	392.76	213.34	392.76	216.01	392.76	220.01	392.17223	2401	392.16
	223.78	392.16	226.52	392.16	238.25	393.15	239.96	393.12	241.76	393.08
	243.65	393.05	245.65	393.01253	9301	392.25	256.07	392.22	258.33	392.19
	260.71	392.16	268	391.68271	4901	391.32	277	391.34	279.65	391.41
	279.69	391.41	291.76	391.34	293.54	391.35	293.82	391.34	296.69	391.28
	300.82	391.01	304.44	391.14	307.54	391.25	311.51	391.01	314.25	390.88
314.	3701	390.88315	1201	390.89	319.34	390.69	320.3	390.7	324.3	390.53
	326.21	390.45	327.51	390.46	333.06	390.53	334.29	390.59	335.52	390.65
	340.71	390.71	343.06	390.73	344.13	390.78	353.1	390.81	353.35	390.82
	353.79	390.82	353.95	390.81	355.81	391.1	359.5	391.6	364.22	391.51
	365.08	391.5	369.79	391.41	374.58	391.32	375.06	391.31	376.7	391.33
	380.15	391.08	380.75	391.03	385.51	390.66387	6801	390.45	391.57	390.13
	393.38	389.86	396.72	389.57	400.16	389	405.06	388.19	406.03	388.02
	406.84	387.88	411.39	387.23	411.84	387.18	414.3	386.91	427.52	384.02
	429.56	381.39	431.66	379.05	437.88	381.22	438.52	381.48	439.5	383.91
	455.71	389.61	473.01	390.03	473.76	390.06	474.6	390.09	474.62	390.09
	474.76	390.1	488.4	389.89	488.83	389.9	489.27	389.92	489.7	389.93
	501.3	390.17	503.85	390.26	507.51	390.27	509.96	390.29	511.36	390.31
	513.76	390.32	516.4	390.36	518.7	390.38521	4401	390.42	523.63	390.43
	526.48	390.47528	5601	390.49	531.53	390.53	533.48	390.54	536.58	390.59
	538.39	390.6	541.63	390.66	543.3	390.67546	6901	390.72	548.2	390.73
	551.76	390.79552	6801	390.81	554.14	390.82	555.21	390.86	561.79	390.98
	563.02	391.02566	8101	391.09	568.01	391.14571	8201	391.21	572.99	391.25
	576.84	391.32	577.98	391.36	581.85	391.43	582.97	391.47	583.61	391.48
	584.67	391.52	591.87	391.91	592.95	391.95	596.88	392.17597	9401	392.2
	601.89	392.42602	9301	392.46	606.89	392.67	607.92	392.71	611.9	392.93
	612.63	392.95	613.35	392.99	616.59	393.25	623.11	393.75	626.42	394

Bridge\_Deck\_Adjustm. rep

629.55	394.24	634.77	394.5	636.39	394.62	646.8	394.18	647.5701	394.15
650.23	394.18	658.4401	394.27	672.35	394.21	672.91	394.21	673.27	394.22
673.5601	394.22	680.24	394.49	684.2	394.51	688.5601	394.52	689.98	394.54
694.73	394.56	695.67	394.61	700.36	394.61	700.41	394.61	705.28	394.61
707.27	394.61	710.1	394.64	710.4401	394.65	715.34	394.72	719.87	394.78
721.36	394.79	725.99	394.85	730.27	394.91	734.23	394.96	737.32	394.98
741.3101	395.03	745.01	395.08	751.0601	395.15	755.8101	395.14	756.41	395.16
759.63	395.25	762.8101	395.34	768.1901	395.41	771.22	395.49	774.21	395.58
777.16	395.66	783.1801	396.17	785.96	396.25	788.69	396.33	791.39	396.41
794.94	396.57	798.5	396.67	802.72	396.82	806.2	396.92	812.0601	397.09
813.0601	397.18	817.6801	396.86	821	396.89	824.3101	396.93	827.6	396.97
832.57	396.91	835.75	396.95	838.91	396.98	842.0601	397.02	847.4301	396.95
850.45	396.98	853.46	397.01	859.4	397.31	864.0601	397.36	865.09	397.37
868.1	397.39	871.45	397.42	874.46	397.36	878.4901	397.4	881.4	397.48
885.2401	397.51	889.41	397.55	893.95	397.59	895.53	397.59	897.83	397.61
903.59	398								

Manning's n Values	num=	3
Sta n Val Sta	n Val Sta n Val	
0 .055 414.3	.035 455.71 .055	

Bank Sta: Left Right	Lengths: Left Channel Right	Coeff Contr.	Expan.
414.3 455.71	57.7 57.7 57.7	.1	.3

CROSS SECTION

RIVER: Little Goldstream  
 REACH: Stream Centerline RS: 259.82

INPUT

Description: Downstream  
 Station Elevation Data

Sta	Elev	Sta	num=	206	Sta	Elev	Sta	Elev	Sta	Elev
0	3904.96	0022	390.23	6.72	998	390.32	12.06	390.416	45001	390.3
19.16	390.24	22.47	390.41	28.06	390.73	29.60	390.74	32.82	001	390.76
38.03	390.78	42.56	390.81	142.79	390.81	142.91	390.81	148.35	999	390.8
51.35	390.86	53.84	390.87	58.31	390.98	59.59	391.03	60.13	391.04	
66.82	391.27	70.29	391.38	74.02	391.58	74.46	391.78	71.23	391.72	
83.08	391.77	86.27	391.84	91.96	391.97	94.98	392.04	100.4	392.2	
103.58	392.28	107.91	392.23	110.06	392.28	112.2	392.34	114.32	392.39	
122.01	392.76	124.45	392.82	124.79	392.83	129.29	392.89	136.28	392.81	
138.95	392.85	141.61	392.88	144.27	392.91	150.67	393.11	153.54	393.14	
156.39	393.18	162.13	393.24	165.16	393.28	167.34	393.31	172.2	393.18	
180.32	392.87	194.7	392.57	196.03	392.51	210.62	392.63	211	392.63	
211.46	392.57	218.1	391.84	223.56	391.61	226	391.48	227.3	391.36	
230.44	391.07	237.02	390.54	237.75	390.46	242.92	389.86	248.69	389.53	
251.9	389.35	255.52	389.28	261.79	389.1	264.2	389.05	267.29	388.9	
274.59	388.93	274.81	388.92	274.99	388.93	275.1	388.94	275.93	388.94	
278.08	388.92	287.71	388.91	289.26	388.91	291.4	388.94	298.17	389.11	
298.7	389.12	310.18	389.1	310.76	389.11	311.43	389.13	312.73	389.16	
320.18	389.5	321.11	389.5	329.65	389.56	332.67	389.56	333.26	389.57	
334.94	389.59	345.09	389.87	346.27	389.89	346.39	389.89	348.19	389.99	
360.52	391.16	360.84	391.18	361.74	391.2	368.04	391.08	374.07	391.42	
375.2	391.49	377.86	391.27	378.38	391.23	389.98	390.36	404.9	382.79	
407.24	381.58	408.71	381.19	409.96	380.62	411.3	380.16	413.29	379.47	
416.67	383.16	417.59	383.99	418.97	384.41	431.05	389.28	445.8	391.99	
447.31	392.24	447.55	392.24	453.37	391.68	456.47	391.66	459.59	391.65	
465.05	391.59	468.06	391.57	471.08	391.56	474.11	391.54	477.23	391.21	
483.51	391.19	486.91	391	488.19	391.02	496.31	391.12	498.59	391.29	
507.13	391.32	513	391.34	513.45	391.34	520.99	390.04	525.13	388.76	
531.7	388.05	540.2	387.59	549.18	389.04	553.44	389.63	556.09	389.79	
560.52	389.79	565.36	390.2	567.6	390.88	569.66	390.64	574.68	391.05	



Bridge\_Deck\_Adjustm.rep

580.14	391.61	581.76	391.76	583.48	391.79	592.18	391.72	594.43	391.92
602.6	392.56	607.86	392.99	611.14	393.26	613.07	393.39	617.08	393.67
625.17	394.22	635.19	394.48	641.38	394.61	643.87	394.64	646.96	394.7
650.32	394.66	656.53	394.68	664.68	394.74	666.69	394.72	668.88	394.73
673.76	394.67	678.25	394.73	680.84	394.72	683.66	395	687.92	395.16
691.82	394.99	695	394.74	698.45	394.86	702.07	394.91	705.4	395
709.15	395	713.24	395.13	716.23	395.22	718.97	395.15	723.31	395.03
728.03	394.85	730.38	394.74	732.54	394.76	737.46	394.71	742.82	394.95
744.54	394.97	746.12	394.96	751.62	394.77	757.61	394.88	759.26	394.89
759.75	394.88	760.82	394.87	769.65	394.76	773.63	394.75	776.66	394.74
779.45	394.94	781.86	395.03	786.98	395.32	789.81	395.48	799.94	396.04
800.42	396.06	801.16	396.11	801.97	396.17	813.99	396.97	816.76	397.19
827.56	398								

Manning's n Values num= 3  
 Sta n Val Sta n Val Sta n Val  
 0 .055 389.98 .035 431.05 .055

Bank Sta: Left Right Lengths: Left Channel Right Coeff Contr. Expan.  
 389.98 431.05 78.37 78.37 78.37 .1 .3

CROSS SECTION

RIVER: Little Goldstream  
 REACH: Stream Centerline RS: 181.45

INPUT

Description: Most Downstream Cross Section

Station		Elevation Data		num= 233		Elev		Sta		Elev		Sta		Elev	
Sta	Elev	Sta	Elev	Sta	Elev	Sta	Elev	Sta	Elev	Sta	Elev	Sta	Elev	Sta	Elev
0	390.2	580017	390.149	110046	390.581	13.65002	390.617	68005	390.62						
27.55005	390.66	28.59003	390.67	28.75	390.67	29.41003	390.67	31.06006	390.66						
37.01001	390.58	41.33002	390.64	44.17004	390.59	48.10004	390.62	51.33002	390.63						
53.68005	390.71	58.49005	390.83	65.13	391.07	65.65002	391.07	66.03003	391.08						
72.81006	391.17	78.38	391.27	79.97003	391.28	82.17004	391.23	87.14001	391.16						
90.73004	391.28	94.30005	391.48	99.21002	391.5	101.46	391.53	103.08	391.53						
113.28	391.89	115.4301	391.97	115.78	391.98	116.25	391.98	122.94	392.03						
127.78	392.07	130.1	392.13	133.29	392.23	137.26	392.37	140.13	392.44						
144.42	392.52	150.33	392.61	151.58	392.64	152.4901	392.66	158.7401	392.66						
164.84	392.71	165.9	392.74	167.3701	392.75	173.0601	392.8	177.19	392.94						
180.22	392.98	184.41	393.32	187.38	393.5	189.54	393.55	194.54	393.43						
201.45	393.62	201.7	393.62	201.89	393.63	208.86	394.01	214.2401	394.1						
216.02	394.08	219.3	393.9	223.46	393.74	234.1	393.31	235.0601	393.4						
251.29	394.49	252.5601	394.46	263.64	394.58	267.08	394.65	267.67	394.64						
278.39	395.08	280.72	395.24	282.6	395.36	284.8	395.51	294.6	395.76						
296.3701	396.02	298.42	396.12	302.25	396.32	302.56	396.33	304.06	396.36						
307.01	396.52	312.83	396.8	315.48	396.69	320.36	396.79	322.14	396.69						
326.09	396.74	327.53	396.64	328.8	396.55	329.85	396.55	333.51	396.27						
336.6	396.13	341.81	395.78	342.08	395.77	343.17	395.69	348.25	395.19						
359.78	393.84	360.23	393.77	360.64	393.73	360.87	393.7	368.35	392.15						
370.59	391.89	371.26	391.81	371.8	391.77	380.14	391.43	380.67	391.39						
381.61	391.32	383.27	391.2	386.1	391	387.65	390.88	393.2	389.93						
393.37	389.92	396.52	389.75	401.15	389.77	402.94	389.65	405.07	389.52						
405.73	389.47	411.8	389.08	412.21	389.05	414.74	388.88	416.72	388.67						
416.93	388.66	417.1	388.66	420.78	388.49	438.79	378.76	439.1	378.83						
439.26	378.93	439.28	378.94	439.36	378.97	439.38	378.98	439.54	379.04						
439.74	379.12	439.78	379.14	440.01	379.23	440.11	379.29	440.4	379.46						
440.45	379.49	440.48	379.51	453.46	387.32	454.73	388.08	454.8	388.09						
456.61	388.36	466.2	389.39	467.4	389.53	467.57	389.55	474.66	389.81						
480.85	390.38	482.47	390.39	483.72	390.36	493.02	390.16	495.17	390.49						
499.43	391.16	502.16	391.45	504.39	391.69	515.67	392.78	520.29	393.34						
520.79	393.3	524.35	393.1	527.36	393.03	531.52	392.77	537.34	392.45						

Bridge\_Deck\_Adjustm.rep

538.6901	392.46	539.65	392.53	545.85	392.91	551.94	393.15	553.49	393.34
554.54	393.32	561.74	393.62	564.71	393.68	572.21	393.83	578.12	394.02
579.06	394.02	584.77	394.08	589.26	394	590.59	393.99	592.99	393.96
599.32	393.87	603.56	393.83	607.14	393.79	609.31	393.83	610.22	393.85
615.38	393.94	619.01	394.01	623.95	394.19	626.25	394.24	628.77	394.3
637.66	394.78	638.16	394.79	638.51	394.8	640.55	394.76	646.21	394.34
650.26	394.32	653.38	394.24	657.76	394.25	660.55	394.22	662.54	394.24
670.42	394.01	674.55	393.72	676.37	393.59	679.72	393.64	681.77	393.7
692.23	393.91	707.58	394.2	710.73	394.31	711.7	394.38	717.55	394.51
723.72	394.68	724.66	394.7	730.41	394.75	730.96	394.75	735.26	394.89
735.82	394.9	735.91	394.9	741.07	395.02	745.42	395.12	749.15	395.21
752.04	395.38	756.12	395.49	759.35	395.57	762.84	395.67	765.82	395.75
772.28	395.83	774.74	395.9	774.86	395.9	775.88	395.93	785.78	396.48
787.5	396.54	789.12	396.58	790.63	396.63	799.59	397.05	801.59	397.11
809.8	397.96	810.31	397.98	810.78	398				

Manning's n Values num= 3

Station	Value	Station	Value	Station	Value
0	.055	420.78	.035	454.73	.055

Bank Sta:	Left	Right	Lengths:	Left Channel	Right	Coeff	Contr.	Expan.
	420.78	454.73		0	0		.1	.3
Left Levee		Station=	320.36	Elevation=	396.79			
Right Levee		Station=	637.66	Elevation=	394.78			

SUMMARY OF MANNING'S N VALUES

River: Little Goldstrea

Reach	River Sta.	n1	n2	n3
Stream Centerlin	640.59	.055	.035	.055
Stream Centerlin	583.05	.055	.035	.055
Stream Centerlin	527.1	.055	.035	.046
Stream Centerlin	497.46	.046	.035	.046
Stream Centerlin	450	Bridge		
Stream Centerlin	434.05	.046	.035	.046
Stream Centerlin	376.11	.055	.035	.055
Stream Centerlin	317.52	.055	.035	.055
Stream Centerlin	259.82	.055	.035	.055
Stream Centerlin	181.45	.055	.035	.055

SUMMARY OF REACH LENGTHS

River: Little Goldstrea

Reach	River Sta.	Left	Channel	Right
Stream Centerlin	640.59	57.54	57.54	57.54
Stream Centerlin	583.05	55.95	55.95	55.95
Stream Centerlin	527.1	272.34	272.34	272.34
Stream Centerlin	497.46	63.41	63.41	63.41
Stream Centerlin	450	Bridge		
Stream Centerlin	434.05	60	60	60
Stream Centerlin	376.11	58.59	58.59	58.59
Stream Centerlin	317.52	57.7	57.7	57.7
Stream Centerlin	259.82	78.37	78.37	78.37
Stream Centerlin	181.45	0	0	0

SUMMARY OF CONTRACTION AND EXPANSION COEFFICIENTS  
 River: Little Goldstrea

Reach	River Sta.	Contr.	Expan.
Stream Centerlin	640.59	.1	.3
Stream Centerlin	583.05	.1	.3
Stream Centerlin	527.1	.2	.4
Stream Centerlin	497.46	.3	.5
Stream Centerlin	450	Bri dge	
Stream Centerlin	434.05	.3	.5
Stream Centerlin	376.11	.2	.4
Stream Centerlin	317.52	.1	.3
Stream Centerlin	259.82	.1	.3
Stream Centerlin	181.45	.1	.3

Bridge\_Deck\_Adjustm.rep

HEC-RAS Version 4.1.0 Jan 2010  
U.S. Army Corps of Engineers  
Hydrologic Engineering Center  
609 Second Street  
Davis, California

```
X      X  XXXXXX      XXXX      XXXX      XX      XXXX
X      X  X          X      X      X  X      X
X      X  X          X      X      X  X      X
XXXXXXXX XXXX      X      XXX XXXX      XXXXXX      XXXX
X      X  X          X      X      X  X      X
X      X  X          X      X      X  X      X
X      X  XXXXXX      XXXX      X  X      X  X      XXXXX
```

PROJECT DATA

Project Title: Bridge\_Deck\_Adjustment  
Project File : Bridge\_Deck\_Adjustm.prj  
Run Date and Time: 3/22/2016 12:21:44 PM

Project in English units

Project Description:  
ADOT&PF Parks Highway MP 305-325 Reconstruction  
Project 148830

Survey

points were collected between September 9, 2015 and November 19, 2015 by Design Alaska, Inc. and managed by William Kinne, PLS. All work was conducted with RTK GPS. Coordinates were translated to "Fairbanks 05-15-15". Elevations were calculated using the Geoid 12B model, NAVD88 datum. Two benchmarks set at the Little Goldstream Creek Bridge were established with differential levels from a primary control monument.

PLAN DATA

Plan Title: Final\_Deck\_90ft  
Plan File : t:\AKDOT\148830 - DOT&PF Parks 305-325 PI\03 Engineering\Hydrology and Hydraulics\HEC-RAS Model\HECRAS\030416\_Scour\_Analysi s\Bridge\_Deck\_Adjustm.p24

Geometry Title: Bridge\_Deck\_90ft  
Geometry File : t:\AKDOT\148830 - DOT&PF Parks 305-325 PI\03 Engineering\Hydrology and Hydraulics\HEC-RAS Model\HECRAS\030416\_Scour\_Analysi s\Bridge\_Deck\_Adjustm.g06

Flow Title : Steady\_USGS\_2003  
Flow File : t:\AKDOT\148830 - DOT&PF Parks 305-325 PI\03 Engineering\Hydrology and Hydraulics\HEC-RAS Model\HECRAS\030416\_Scour\_Analysi s\Bridge\_Deck\_Adjustm.f04

Plan Summary Information:

Number of:	Cross Sections	=	9	Multiple Openings	=	0
	Culverts	=	0	Inline Structures	=	0
	Bridges	=	1	Lateral Structures	=	0

Bridge\_Deck\_Adjustm.rep

Computational Information

Water surface calculation tolerance = 0.01  
 Critical depth calculation tolerance = 0.01  
 Maximum number of iterations = 20  
 Maximum difference tolerance = 0.3  
 Flow tolerance factor = 0.001

Computation Options

Critical depth computed only where necessary  
 Conveyance Calculation Method: At breaks in n values only  
 Friction Slope Method: Average Conveyance  
 Computational Flow Regime: Subcritical Flow

FLOW DATA

Flow Title: Steady\_USGS\_2003

Flow File : t:\AKDOT\148830 - DOT&PF Parks 305-325 PI\03 Engineering\Hydrology and Hydraulics\HEC-RAS Model\HECRAS\030416\_Scour\_Analyses\Bridge\_Deck\_Adjustm.f04

Flow Data (cfs)

River	Reach	RS	Q100	Q500
Little Goldstream	Stream Centerline	640.59	1555	2162

Boundary Conditions

River	Reach	Profile	Upstream
Downstream			

Little Goldstream Centerline Q100

Normal S = 0.0005

Little Goldstream Centerline Q500

Normal S = 0.0005

GEOMETRY DATA

Geometry Title: Bridge\_Deck\_90ft

Geometry File : t:\AKDOT\148830 - DOT&PF Parks 305-325 PI\03 Engineering\Hydrology and Hydraulics\HEC-RAS Model\HECRAS\030416\_Scour\_Analyses\Bridge\_Deck\_Adjustm.g06

CROSS SECTION

RIVER: Little Goldstream

REACH: Stream Centerline RS: 640.59

INPUT

Description: Most Upstream Cross Section

Station Elevation Data num= 251

Sta	Elev	Sta	Elev	Sta	Elev	Sta	Elev	Sta	Elev
0	393.051	580017	392.94	6.01001	393.096	679993	393.041	11.41003	393.17
15.91003	393.281	6.58002	393.262	1.23004	393.372	2.28003	393.382	6.96002	393.49

Bridge\_Deck\_Adjustm. rep

31.48999	393.6	35.87	393.737	66003	393.6942	05005	393.7949	92999	393.96
50.42004	393.9552	96002	393.956	98004	393.85	61.13	393.865	42004	393.74
67.61005	393.83	71.75	393.76	76.06	393.6980	53003	393.62	81.44	393.55
86.13	393.4987	07001	393.4391	67004	393.3792	53003	393.35	101.45	393.24
107.59	393.98	107.89	393.98	107.91	393.98	108.41	393.93	108.79	393.9
123.93	392.54	124.69	392.52	125.07	392.51	132.31	392.3	133.46	392.27
137.74	392.17	140.36	392.1	143.04	392.04	145.37	392.14	151.24	392.86
155.12	393.25	156.32	393.37	159.26	393.7	162.89	393.64	165.44	393.77
173.62	393.14	175.87	393.2	177.88	393.26	185.58	394.32	186.33	394.35
186.99	394.38	193.59	394.91	194.51	394.98	197.85	395.16	203.88	395.39
206.51	395.49	210.97	395.66	215.07	395.68	216.58	395.74	222.32	395.78
223.39	395.79	230.75	395.7	236.71	395.63	237.75	395.55	241.72	395.5
249.68	395.42	249.94	395.42	250.05	395.42	250.31	395.42	250.69	395.42
250.83	395.42	252.75	395.39	253.29	395.44	257.97	395.38	262.78	395.31
267.71	395.24	272.78	395.17	272.79	395.18	281.73	396.64	283.32	396.48
286.74	396.39	287.31	396.41	291.18	395.71	297.17	394.47	297.4	394.5
298.32	394.5	307.48	393.43	309.89	393.35	317.56	393.62	321.47	393.38
327.65	393.28	333.04	393.03	337.73	392.97	341.35	392.31	347.93	391.53
350.96	391.29	351.69	391.37	353.08	391.21	358.44	390.62	361.03	390.32
361.34	390.3	375.39	383.74	379.38	383.3	385.48	383	392.2	382.67
396.36	384.07	414.75	395.89	415.47	396.29	415.56	396.32	421.95	396.59
422.96	396.64	424.32	396.7	428.36	396.93	431.42	397.01	436.65	396.81
442.67	396.82	442.74	396.82	442.84	396.82	447.47	396.61	449.9	396.53
452.8	396.52	453.68	396.48	457.9	396.48	462.57	396.48	462.66	396.48
467.25	396.39	471.24	396.32	472.91	396.08	473.45	396.04	477.99	395.85
478.87	395.78	483.05	395.59	484.32	395.47	489.85	395.35	491.29	395.19
492.26	395.07	500.67	393.99	503.9	393.83	508.02	393.63	513.96	393.22
515.35	393.2	520.29	393.135	22.0601	393.11	525.78	393.1	531	393.03
533.39	393.2	538.08	393.55	539.04	393.58	542.75	393.9	543.49	393.9
544.72	393.91	544.82	393.92	552.96	393.8	553.28	393.81	553.84	393.83
561.78	394.045	561.9401	394.09	563.01	394.19	563.79	394.17	570.23	394.47
573.74	394.655	576.1901	394.785	578.8101	394.91	587.9	395.11	588.65	395.14
589.88	395.17	591.02	395.07	595.3	394.85	601.29	394.91	606.7	394.85
612.24	394.75	616.66	394.77	619.98	394.78	629	394.87	632.74	394.88
639.6901	395.08	639.7	395.08	639.72	395.08	652.72	395.18	653.12	395.18
653.75	395.16	654.39	395.14	655.24	395.1656	4301	395.06	664.58	394.48
668.14	394.39	673.1	394.24	676.56	394.16	680.9	394.07	682.89	394.03
686.85	393.93	687.63	393.91	692.45	393.81	698.16	393.69	703.58	394.18
703.75	394.18	703.95	394.18	710.86	393.75	716.36	393.67	717.98	393.61
720.02	393.53	725.1	393.42	729.14	393.09	732.21	392.99	736.09	392.97
739.33	393.02	741.91	393.12	746.45	393.26	752.15	393.14	754.49	393.15
754.63	393.15	755.65	393.19	760.47	393.35	767.3	393.58	777.03	394.13
779.6801	394.28	780.66	394.33	784.28	394.68	789.15	395.36	793.02	395.39
796.27	395.68	804.23	396.37	813.48	397.14	818.06	397.46	829.8	398.28
830.63	398.34	831.27	398.36	831.47	398.37	832.48	398.44	838.97	398.48
853.67	399.34	853.69	399.34	853.76	399.36	857.47	400.14	876.5	404.24
879.94	405.49	888.79	408.81	895.23	410.46	895.9	410.61	896.74	410.83
903.02	412.37	908.01	413.44	910.14	413.79	921.28	414.64	922.67	414.77
927.27	414.84								

Manning's n Values  
 Sta 0 .055 361.34  
 num= 3  
 Sta 0 .035 415.56  
 Sta n Val .055

Bank Sta: Left 361.34 Right 415.56 Lengths: Left Channel 57.54 Right 57.54 Coeff Contr. .1 Expan. .3  
 Left Levee Station= 281.73 El evati on= 396.641  
 Right Levee Station= 431.42 El evati on= 397.01

CROSS SECTION

RIVER: Little Goldstrea

REACH: Stream Centerlin

RS: 583.05

INPUT

Description: Upstream

Station Elevation Data

num= 246

Sta	Elev	Sta	Elev	Sta	Elev	Sta	Elev	Sta	Elev
0	392.821	390015	392.78	2.01001	392.776	530029	392.896	790039	392.89
11.46002	393.0211	79999	393.0216	59003	393.1616	82001	393.1621	70001	393.29
21.94	393.326	85004	393.4426	85999	393.4426	90002	393.44	29.37	393.51
31.85999	393.5736	72003	393.6837	09003	393.6842	01001	393.7850	82001	393.98
51.37	393.9752	46002	393.9557	01001	393.8961	71002	393.8366	54999	393.76
67.10004	393.7871	85999	393.7176	79004	393.63	78.56	393.681	79004	393.54
81.84003	393.54	86.75	393.4486	89001	393.4491	72003	393.3591	92999	393.36
101.29	393.19	101.65	393.19	102.01	393.2	107.8	393.86	107.95	393.86
108.67	393.86	123.9	392.52	124.26	392.52	125.5	392.54	131.12	392.38
132.5	392.35	135.62	392.27	139.79	392.16	144.02	392.06	144.84	392.1
146.92	392.35	153.61	393.02	155.67	393.23	160.69	393.79	163.48	393.75
165.44	393.85	174.76	393.13	176.6	393.18	178.25	393.23	186.81	394.41
187.06	394.42	187.28	394.43	189.79	394.63	193.72	394.8	194.24	394.81
195.38	394.92	199.24	395.12	204.5	395.33	206.81	395.42	210.7	395.56
215.96	395.6	217.31	395.64	222.43	395.68	223.38	395.69	229.97	395.61
235.31	395.55	237.23	395.4	241	395.36	248.56	395.28	249.14	395.29
249.41	395.29	250	395.28	250.88	395.28	251.19	395.27	253.01	395.25
254.3	395.37	258.64	395.31	263.09	395.25	267.66	395.19	272.36	395.12
273.36	395.13	275.06	395.8	280.68	396.72	285.63	396.2	289.67	396.24
292.74	395.73	296.52	395.19	302.57	394.47	306.96	394.36	312.35	394.1
314.07	393.93	315.46	393.89	321.17	393.79	328.18	392.64	328.28	392.63
328.36	392.63	335.39	392.33	348.03	390.48	348.74	390.38	358.55	385.54
371.67	383.49	374.89	382.99	377.23	384.78	388.97	390.12	391.57	390.71
393.79	391.2	397.64	392.07	400.03	392.61	402.26	393.11	403.81	393.45
407.51	393.8	410.15	394.13	414.79	394.62	417.26	394.9	419.69	395.16
425.95	395.88	425.96	395.89	425.98	395.89	430.28	396.05	441.56	396.47
444.92	396.48	447.05	396.4	449.49	396.39	451.91	396.28	455.17	396.28
458.84	396.28	463.02	396.28	465.37	396.3	469.41	396.3	474.02	396.29
474.46	396.27	476.78	396.28	479.13	396.18	479.27	396.17	486.55	396.02
486.79	395.99	486.95	395.97	499.36	394.38	500.62	394.32	502.22	394.24
512.62	393.53	513.33	393.52	515.89	393.48	516.8	393.47	525.01	393.45
528.14	393.4	529.57	393.51	532.37	393.72	538.19	393.89	541.1	394.14
541.94	394.21	547.74	394.2	551.73	394.4	551.98	394.4	558.02	394.44
558.88	394.52	563.32	394.43	568.04	394.65	574.51	394.98	575.76	395.04
577.1	395.11	583.53	395.26	586.22	395.25	588.37	395.26	592.34	395.06
595.87	395.09	604.63	394.99	613.65	394.83	614.4	394.84	614.96	394.84
627.5601	394.97	628.97	394.97	631.59	395.04	636.03	395.19	639.58	395.17
647.6	395.26	650.26	395.26	652.38	395.11659	4301	394.61	661.49	394.55
670.21	394.29	672.42	394.24	675.19	394.18	681.31	394.08	684.02	394.01
687.5	393.92	694.97	393.73	695.2	393.72	695.35	393.73	695.96	393.72
703.58	393.95	707.18	393.72	711.67	393.66	714.29	393.61	716.38	393.69
721.41	393.58	727.69	393.06	728.52	392.98	729.18	392.98	735.64	393.08
741.99	393.33	742.75	393.35	743.71	393.33	753.93	393.36	754.54	393.38
759.01	393.54	761.93	393.64	767.86	393.97	778.33	394.65	780.39	394.9
785.44	395.61	791.76	395.67	792.56	395.69	793.19	395.71	799.23	396.17
809.43	397.01	818.61	397.66	823.8	398.02	828.13	398.19	831.59	398.26
835.25	398.29	842.25	398.69	851.87	399.32	867.32	402.74	873.51	404.24
878.53	406.15	885.05	408.6	887.87	409.32	892.17	410.36	895.6	411.33
899.28	412.23	903.89	413.22	906.4	413.68	911.35	414.17	917.98	414.65
924.64	414.75								

Manning's n Values

num= 3

Sta	n Val	Sta	n Val	Sta	n Val
0	.055	348.74	.035	388.97	.055

Bank Sta: Left 348.74 Right 388.97 Lengths: Left Channel 55.95 Right Channel 55.95 Coeff Contr. .1 Expan. .3



Bridge\_Deck\_Adjustm.rep

Left Levee Station= 280.68 Elevation= 396.72  
 Right Levee Station= 441.56 Elevation= 396.47

CROSS SECTION

RIVER: Little Goldstream  
 REACH: Stream Centerline RS: 527.1

INPUT

Description: Upstream

Station	Elevation	Data	num=	239	Station	Elevation	Station	Elevation	Station	Elevation	
0	391.45	.0999			391.457	809998	391.629	019958	391.622	17999	391.91
22.77997	391.92	34.31			391.893	6.23999	391.89	39.94	391.474	6.84998	391.46
54.87	391.42	60.32996			391.416	9.78998	391.467	3.79999	391.688	4.70996	392.22
86.38995	392.23	99.88			392.57	100.22	392.57	100.59	392.58	111.14	392.58
114.28	392.61	114.33			392.61	114.38	392.61	114.44	392.61	128.09	392.98
128.35	392.98	129.47			392.92	141.17	393.36	144.4	393.68	151.21	394.18
153.65	394.39	153.69			394.39	159.04	394.95	160.67	395.15	167.11	395.49
167.3	395.5	169.05			395.61	173.15	395.74	176.41	395.69	176.67	395.68
179.37	395.64	183.48			395.52	188.7	395.52	188.72	395.52	188.74	395.54
190.99	395.56	192.38			395.56	198.3	395.55	200.17	395.52	202.96	395.49
207.21	395.44	211.24			395.4	213.78	395.36	218.74	395.3	220.99	395.16
224.75	394.94	230.15			395.01	233.55	394.84	234.3	394.57	236.53	394.45
236.93	394.42	240.18			394.31	243.62	394.09	245.8199	394.01	247.95	393.87
249.62	393.81	253.13			393.56	254.04	393.53	258.3	393.21	259.18	393.15
261.45	393.11	261.99			393.11	268.3	393.03	273.88	392.95	276.61	392.96
278.3	392.8	287.71			392.93	289.75	392.8	290.81	392.85	291.64	392.89
292.3	392.93	304.0699			392.83	305	392.87	308.53	393	312.34	393.11
314.54	393.12	321.6			393.22	322.59	393.22	330.87	393.23	331.61	393.23
333.29	393.22	341.62			393.23	343.23	393.23	351.63	393.24	353.17	393.23
361.63	393.24	363.11			393.24	371.64	393.25	373.16	393.25	376.72	392.81
376.95	392.83	376.99			392.84	383.02	394.52	383.22	394.4	386.35	392.53
387.5699	391.8	388.52			391.22	391.12	389.67	392.7599	388.69	393.12	388.47
401.17	383.86	402.25			382.52	405.79	382.69	413.0099	385.11	413.17	385.16
413.56	385.28	414.35			385.53	414.83	385.69	415.85	386.01	416.47	386.21
417.83	386.64	418.66			386.91	419.54	387.19	424.26	388.7	425	388.93
425.34	389.04	428.18			389.95	428.59	390.06	434.99	391.89	443.33	392.7
445.34	392.89	455.57			393.85	460.69	394.04	471.07	394.59	473.3	394.51
481.09	394.65	482.79			394.66	491.1	394.82	500.4	394.92	501.16	394.94
501.21	394.94	501.57			394.94	502	394.94	514.89	395.15	517.12	395.17
517.39	395.17	527.37			395.29	530.65	395.35	532.97	395.39	540.05	395.55
542.64	395.59	545.72			395.64	549.4299	395.7	553.17	395.72	556.85	395.79
561.27	395.87	565.67			395.95	566.4399	395.95	566.66	395.95	571.86	395.96
578.27	395.96	580.05			395.96	583.48	395.97	590.85	395.95	598.1899	395.92
602.09	396.05	608.72			396.03	611.38	395.93	619.12	395.9	622.5	395.99
629.76	395.96	634.24			396	637.99	395.99	640.64	395.96	643.25	395.94
650.66	395.67	652.8099			395.63	654.5599	395.6	656.01	395.58	667.02	395.55
667.63	395.54	668.14			395.53	674.0599	395.25	680.73	394.81	682.1	394.83
684.18	394.75	692.7			394.66	696.54	394.6	702.36	394.32	704.67	394.21
710.97	394	716.65			393.82	718.1899	393.82	720.54	393.75	725.41	393.6
728.62	393.53	732.63			393.46	738.72	393.32	739.85	393.3	740.86	393.29
741.46	393.3	751.49			393.43	754.1899	393.5	759.96	393.65	760.53	393.71
775.95	395.12	776.52			395.18	783.17	395.84	788.5	396.16	793.25	396.59
797.6	396.92	800.47			397.09	804.8199	397.05	810.93	397.15	815.89	396.99
822.27	397.73	826.48			398.13	829.61	397.93	833.7	397.74	836.39	397.91
840.92	398.33	847.79			398.55	848.14	398.55	848.37	398.56	860.96	399.22
862.52	399.27	877			403.05	881.2599	404.24	886.05	405.79	896.27	409.31
898.67	409.9	902.33			410.94	905.89	411.86	908.24	412.37	913.11	413.28
920.97	414.09	924.88			414.57	930.7599	414.66	931.6	414.67		

Manning's n Values

num= 3

Bridge\_Deck\_Adjustm.rep

Sta n Val Sta n Val Sta n Val  
 0 .055 386.35 .035 428.18 .046

Bank Sta: Left Right Lengths: Left Channel Right Coeff Contr. Expan.  
 386.35 428.18 272.34 272.34 272.34 .2 .4  
 Left Levee Station= 383 Elevati on= 394.53  
 Right Levee Station= 608.72 Elevati on= 396.03

CROSS SECTION

RIVER: Little Goldstrea  
 REACH: Stream Centerlin RS: 497.46

INPUT

Description: Upstream of Proposed Bridge  
 Station Elevati on Data num= 201

Sta	Elev	Sta	Elev	Sta	Elev	Sta	Elev	Sta	Elev
0	393.73	8.43	393.5	8.59	393.5	8.72	393.5	8.84	393.5
8.96	393.49	11.96	393.39	22.02	393.24	24.2	393.24	34.97	393.5
39.95	393.57	44.6	394.05	45.76	394.05	57.22	393.75	58.22	393.74
58.86	393.74	60.46	393.75	72.57	393.71	73.36	393.71	84.66	393.6
86.87	393.6	86.94	393.6	87.01	393.6	100.18	393.54	100.66	393.55
101.14	393.55	101.64	393.55	113.78	393.76	114.62	393.76	118.7	393.88
122.12	394.18	124.04	394.2	135.94	394.03	136.97	394.03	137.17	394.03
150.47	393.85	150.88	393.85	151.3	393.85	157.36	393.91	164.88	394.04
165.46	394.04	178.1	394.27	179.61	394.28	190.7	394.33	192.99	394.33
195.4	394.34	205.28	394.56	211.08	394.57	215.21	394.58	221.1	394.59
225.14	394.6	231.13	394.61	241.9	394.77	243.04	394.77	244.25	394.77
256.11	394.7	256.55	394.7	258.37	394.7	268.52	394.76	271.61	394.77
274.75	394.77	281.21	394.63	284.87	394.62	291.22	394.63	294.85	394.62
301.22	394.62	304.83	394.61	311.23	394.62	312.36	394.61	314.42	394.61
320.86	394.62	331.73	394.64	334.48	394.64	337.28	394.65	346.85	394.79
350.45	394.8	351.32	394.8	354.04	394.79	361.46	394.63	364.29	394.61
370.92	394.6	372.61	394.59	374.3	394.58	380.91	394.56	382.61	394.55
384.32	394.55	395.63	394.1	397.82	394.09	399.97	394.09	410.08	394.39
413.09	394.38	416.03	394.37	425	390	425.35	390.02	480	382.54
490	382.54	544.79	390	545	390	546.58	393.23	548.87	393.78
550.07	393.79	550.4	393.79	559.53	393.79	561.33	393.78	566.8	393.78
612.68	393.77	615.89	393.78	622.63	393.77	625.89	393.78	632.57	393.77
635.9	393.78	637.37	393.78	643.99	393.77	645.9	393.77	651.57	393.69
655.31	393.67	661.72	393.48	661.93	393.47	661.98	393.47	665.36	393.49
675.62	393.56	676.06	393.56	676.48	393.56	688.59	393.38	689.98	393.52
694.01	393.5	698.6	393.56	703.81	393.63	706	393.62	708.57	393.66
713.3	393.75	713.76	393.75	715.24	393.78	718.13	393.98	718.64	394
721.56	394.19	722.61	394.23	727.52	394.54	729.37	394.6	729.97	394.64
731.26	394.71	732.42	395.12	734.65	395.24	743.52	395.11	746.53	395.3
748.33	395.41	752.31	395.45	757.2	395.53	760.39	395.57	763.75	395.6
765.96	395.63	770.46	395.7	775.08	395.7	776.16	395.71	781.18	395.67
781.24	395.63	781.27	395.61	785.95	395.62	794.71	395.86	795.26	395.87
795.31	395.87	795.98	395.88	796.81	395.85	797.17	395.83	797.21	395.83
799.26	395.72	808.48	395.26	811.9	394.9	811.96	394.89	815.55	394.59
823.44	394.01	824.14	393.96	824.18	393.96	824.6	393.94	824.89	393.94
837.49	393.43	838.69	393.41	839.8	393.4	852.13	393.13	853.65	393.11
865.29	393.09	867.18	393.07	868.95	393.05	880.44	392.76	885.11	392.73
891.47	392.41	900	391.94	904.96	391.91	914.9	391.94	918.45	391.95
929.79	391.97	931.01	392.11	931.64	392.11	945.02	392.14	945.25	392.14
952.78	391.96	958.99	391.85	959.19	391.85	959.39	391.85	959.44	391.85
967.8	391.75								

Manning's n Values num= 3  
 Sta n Val Sta n Val Sta n Val  
 0 .046 416.03 .035 548.87 .046

Bridge\_Deck\_Adjustm. rep

Bank Sta: Left Right Lengths: Left Channel Right Coeff Contr. Expan.  
 416.03 548.87 63.41 63.41 63.41 .3 .5  
 Left Levee Station= 351.55 Elevati on= 394.79  
 Right Levee Station= 795.99 Elevati on= 395.88

BRI DGE

RIVER: Little Goldstrea  
 REACH: Stream Centerlin RS: 450

INPUT

Description: Little Goldstream Bridge - Proposed  
 Distance from Upstream XS = 5  
 Deck/Roadway Width = 56  
 Weir Coefficient = 2.6

Upstream Deck/Roadway Coordinates

num= 6  

Sta	Hi Cord	Lo Cord	Sta	Hi Cord	Lo Cord	Sta	Hi Cord	Lo Cord
331.73	394.64	0	440	396.11	0	440	396.11	395.15
530	396.11	395.15	530	396.11	0	734.65	395.24	0

Upstream Bridge Cross Section Data

Station Elevati on Data num= 201

Sta	Elev	Sta	Elev	Sta	Elev	Sta	Elev	Sta	Elev
0	393.73	8.43	393.5	8.59	393.5	8.72	393.5	8.84	393.5
8.96	393.49	11.96	393.39	22.02	393.24	24.2	393.24	34.97	393.5
39.95	393.57	44.6	394.05	45.76	394.05	57.22	393.75	58.22	393.74
58.86	393.74	60.46	393.75	72.57	393.71	73.36	393.71	84.66	393.6
86.87	393.6	86.94	393.6	87.01	393.6	100.18	393.54	100.66	393.55
101.14	393.55	101.64	393.55	113.78	393.76	114.62	393.76	118.7	393.88
122.12	394.18	124.04	394.2	135.94	394.03	136.97	394.03	137.17	394.03
150.47	393.85	150.88	393.85	151.3	393.85	157.36	393.91	164.88	394.04
165.46	394.04	178.1	394.27	179.61	394.28	190.7	394.33	192.99	394.33
195.4	394.34	205.28	394.56	211.08	394.57	215.21	394.58	221.1	394.59
225.14	394.6	231.13	394.61	241.9	394.77	243.04	394.77	244.25	394.77
256.11	394.7	256.55	394.7	258.37	394.7	268.52	394.76	271.61	394.77
274.75	394.77	281.21	394.63	284.87	394.62	291.22	394.63	294.85	394.62
301.22	394.62	304.83	394.61	311.23	394.62	312.36	394.61	314.42	394.61
320.86	394.62	331.73	394.64	334.48	394.64	337.28	394.65	346.85	394.79
350.45	394.8	351.32	394.8	354.04	394.79	361.46	394.63	364.29	394.61
370.92	394.6	372.61	394.59	374.3	394.58	380.91	394.56	382.61	394.55
384.32	394.55	395.63	394.1	397.82	394.09	399.97	394.09	410.08	394.39
413.09	394.38	416.03	394.37	425	390	440	390	480	382.54
490	382.54	530	390	545	390	546.58	393.23	548.87	393.78
550.07	393.79	550.4	393.79	559.53	393.79	561.33	393.78	566.8	393.78
612.68	393.77	615.89	393.78	622.63	393.77	625.89	393.78	632.57	393.77
635.9	393.78	637.37	393.78	643.99	393.77	645.9	393.77	651.57	393.69
655.31	393.67	661.72	393.48	661.93	393.47	661.98	393.47	665.36	393.49
675.62	393.56	676.06	393.56	676.48	393.56	688.59	393.38	689.98	393.52
694.01	393.5	698.6	393.56	703.81	393.63	706	393.62	708.57	393.66
713.3	393.75	713.76	393.75	715.24	393.78	718.13	393.98	718.64	394
721.56	394.19	722.61	394.23	727.52	394.54	729.37	394.6	729.97	394.64
731.26	394.71	732.42	395.12	734.65	395.24	743.52	395.11	746.53	395.3
748.33	395.41	752.31	395.45	757.2	395.53	760.39	395.57	763.75	395.6
765.96	395.63	770.46	395.7	775.08	395.7	776.16	395.71	781.18	395.67
781.24	395.63	781.27	395.61	785.95	395.62	794.71	395.86	795.26	395.87
795.31	395.87	795.98	395.88	796.81	395.85	797.17	395.83	797.21	395.83
799.26	395.72	808.48	395.26	811.9	394.9	811.96	394.89	815.55	394.59
823.44	394.01	824.14	393.96	824.18	393.96	824.6	393.94	824.89	393.94
837.49	393.43	838.69	393.41	839.8	393.4	852.13	393.13	853.65	393.11
865.29	393.09	867.18	393.07	868.95	393.05	880.44	392.76	885.11	392.73

Bridge_Deck_Adjustm. rep									
891.47	392.41	900	391.94	904.96	391.91	914.9	391.94	918.45	391.95
929.79	391.97	931.01	392.11	931.64	392.11	945.02	392.14	945.25	392.14
952.78	391.96	958.99	391.85	959.19	391.85	959.39	391.85	959.44	391.85
967.8	391.75								

Manning's n Values					
Station	Value	Station	Value	Station	Value
0	.046	416.03	.035	548.87	.046

Bank Station	Left	Right	Coeff	Contr.	Expan.
	416.03	548.87	.3		.5
Left Levee		Station=	351.55		Elevation= 394.79
Right Levee		Station=	795.99		Elevation= 395.88

Downstream Deck/Roadway Coordinates									
num= 6									
Station	Hi	Cord	Lo	Cord	Station	Hi	Cord	Lo	Cord
150	393.96		0		315	396.11		0	
405	396.11		395.15		405	396.11		0	
					558.41	394.56			0

Downstream Bridge Cross Section Data									
Station Elevation Data num= 275									
Sta	Elev	Sta	Elev	Sta	Elev	Sta	Elev	Sta	Elev
0	395.47	.63	395.49	3.61	395.55	5.64	395.66	8.6	395.6
10.66	395.54	13.6	395.58	15.67	395.62	18.59	395.63	20.69	395.71
23.59	395.65	25.96	395.64	28.84	395.65	30.72	395.7	33.58	395.55
35.73	395.55	38.57	395.69	40.75	395.7	43.57	395.69	45.76	395.7
48.56	395.66	50.78	395.68	53.55	395.65	55.8	395.65	58.55	395.64
60.81	395.59	63.54	395.52	65.83	395.44	68.54	395.44	70.85	395.35
73.53	395.3	75.86	395.29	78.53	395.28	80.88	395.27	83.52	395.26
85.9	395.25	88.51	395.22	90.91	395.18	93.51	395.13	95.93	394.94
98.5	394.25	100.95	393.96	103.5	393.5	105.96	393.49	108.49	393.68
110.98	393.65	113.84	392.96	116.36	392.93	118.48	392.96	121	393.41
123.48	393.46	126.01	393.78	128.48	393.82	131.01	393.84	133.47	394.29
134	395.04	136.47	395.19	141.01	395.4	143.48	395.37	146	395.22
148.48	395.19	150.99	395.1	153.48	394.88	155.99	394.6	158.48	394.56
160.98	394.55	163.49	394.51	165.98	394.26	168.49	394.08	170.97	393.96
173.49	393.91	175.97	393.9	178.49	393.77	180.96	393.63	183.49	393.62
185.95	393.36	188.49	393.34	190.95	393.34	193.5	393.22	195.94	393.1
198.5	393.08	200.94	392.96	203.5	392.85	205.93	392.82	208.5	392.7
210.92	392.68	213.5	392.78	215.57	392.92	218.16	392.91	220.92	392.96
223.5	392.95	226.1	392.94	230.93	392.93	233.5	392.85	236.09	392.86
240.93	392.87	243.5	392.84	246.09	392.84	250.93	392.85	253.5	392.82
256.08	392.82	260.94	393.19	263.5	393.19	266.07	393.19	270.94	393.19
273.5	393.19	276.61	393.19	279.16	393.07	281.04	393.06	281.41	393.06
284.49	393.07	290.19	392.96	291.27	392.96	291.61	392.97	295.35	392.97
299.05	392.66	300	390	315	390	355	382	365	382
405	390	420	390	421.56	391.86	424.75	392	428.8	392.06
431.71	392.19	435.06	392.32	436.88	392.38	439.93	392.5	449.82	392.62
467.6	393.17	470.89	393.14	474.35	393.17	477.71	393.13	481.25	393.18
484.22	393.1	487.82	393.14	491.63	393.17	494.08	393.28	497.94	393.31
501.25	393.36	502.01	393.49	503.64	393.54	503.85	393.65	504.17	393.75
504.58	393.81	507.8	393.9	509.7	393.91	511.47	393.99	512.28	394.05
513.66	394.11	513.83	394.11	514.14	394.19	514.63	394.19	514.83	394.2
519.72	394.28	529.69	394.28	530.8	394.29	530.93	394.37	531.11	394.37
531.65	394.38	532.19	394.46	541.34	394.46	544.94	394.47	546.6	394.52
558.41	394.56	568.12	394.7	608.01	394.93	620.8	394.95	621.23	394.93
621.24	394.95	621.25	394.92	621.27	394.94	621.29	394.96	634.83	394.93
636.49	394.96	642.32	394.98	644.38	394.95	646.48	394.97	652.33	394.99
654.38	394.96	656.47	394.98	667.97	395	669.94	394.98	672	395
673.15	395.02	681.02	395	683.78	395.02	686.46	395.04	688.42	395.06
694.13	395.08	696.48	395.1	702.18	395.12	704.31	395.14	706.5	395.16
712.12	395.18	714.29	395.2	716.52	395.22	716.63	395.24	722.15	395.26

Bridge\_Deck\_Adjustm. rep

726.52	395.28	732.05	395.3	734.28	395.32	736.52	395.34	739.11	395.36
740	395.38	743.02	395.4	746.28	395.42	752.53	395.44	753.36	395.46
753.5	395.48	754.32	395.5	758.75	395.52	761.26	395.54	763.82	395.56
764.82	395.58	767.97	395.6	778.17	395.62	783.54	395.66	787.64	395.68
792.07	395.68	798	395.7	798.49	395.71	799.3	395.73	806	395.73
808.54	395.75	817.06	395.76	818.55	395.77	819.99	395.78	827.3	395.8
829	395.8	835.88	395.82	836.19	395.83	841.57	395.84	847.39	395.85
853.97	395.87	855.39	395.87	855.93	395.89	856.3	395.89	856.57	395.91
856.61	395.92	856.71	395.93	856.76	395.94	856.81	395.96	856.87	395.96
856.99	395.98	857.82	395.99	857.94	396	866.95	396.01	874.06	396.03
880.54	396.03	881.67	396.05	883.15	396.06	887.72	396.08	893.96	396.08
898.23	396.1	903.39	396.11	906.94	396.12	912.43	396.13	919.06	396.15
919.93	396.15	926.64	396.17	932.92	396.18	933.74	396.2	934.73	396.21
940.84	396.23	945.91	396.23	947.94	396.25	950.4	396.26	955.05	396.28
958.89	396.29	962.15	396.31	965.99	396.31	968.48	396.33	968.96	396.34

Manning's n Values num= 3  
 Sta n Val Sta n Val Sta n Val  
 0 .046 299.05 .035 421.56 .046

Bank Sta: Left Right Coeff Contr. Expan.  
 299.05 421.56 .3 .5  
 Left Levee Station= 141.41 Elevation= 395.42

Upstream Embankment side slope = 0 horiz. to 1.0 vertical  
 Downstream Embankment side slope = 0 horiz. to 1.0 vertical  
 Maximum allowable submergence for weir flow = .98  
 Elevation at which weir flow begins =  
 Energy head used in spillway design =  
 Spillway height used in design =  
 Weir crest shape = Broad Crested

Number of Bridge Coefficient Sets = 1

Low Flow Methods and Data

Energy  
 Momentum Cd = 1.2  
 W. S. Pro Method

W. S. Pro Data

Left Embankment  
 El of the top of the embankment = 395.15  
 El of the toe of the abutment = 360  
 Right Embankment  
 El of the top of the embankment = 395.15  
 El of the toe of the abutment = 360  
 Abtument Type = 1 Vert. abutments and vert. embankments  
 with or without wingwalls  
 Slope of abutments =  
 Top with of embankment = 90  
 Centroid station of bridge opening =  
 Wing Wall Type = No wing walls present  
 Width =  
 Angle =  
 Radius =  
 Guide Banks Type = No Guide Bank present  
 Length =  
 Offset =  
 Angle =

Selected Low Flow Methods = Highest Energy Answer

High Flow Method

Bridge\_Deck\_Adjustm.rep

Energy Only

Additional Bridge Parameters

- Add Friction component to Momentum
- Do not add Weight component to Momentum
- Class B flow critical depth computations use critical depth inside the bridge at the upstream end
- Criteria to check for pressure flow = Upstream energy grade line

CROSS SECTION

RIVER: Little Goldstream  
 REACH: Stream Centerline RS: 434.05

INPUT

Description: Downstream of Proposed Bridge

Station Elevation Data		num= 273		Sta Elev		Sta Elev		Sta Elev	
Sta	Elev	Sta	Elev	Sta	Elev	Sta	Elev	Sta	Elev
0	395.47	.63	395.49	3.61	395.55	5.64	395.66	8.6	395.6
10.66	395.54	13.6	395.58	15.67	395.62	18.59	395.63	20.69	395.71
23.59	395.65	25.96	395.64	28.84	395.65	30.72	395.7	33.58	395.55
35.73	395.55	38.57	395.69	40.75	395.7	43.57	395.69	45.76	395.7
48.56	395.66	50.78	395.68	53.55	395.65	55.8	395.65	58.55	395.64
60.81	395.59	63.54	395.52	65.83	395.44	68.54	395.44	70.85	395.35
73.53	395.3	75.86	395.29	78.53	395.28	80.88	395.27	83.52	395.26
85.9	395.25	88.51	395.22	90.91	395.18	93.51	395.13	95.93	394.94
98.5	394.25	100.95	393.96	103.5	393.5	105.96	393.49	108.49	393.68
110.98	393.65	113.84	392.96	116.36	392.93	118.48	392.96	121	393.41
123.48	393.46	126.01	393.78	128.48	393.82	131.01	393.84	133.47	394.29
134	395.04	136.47	395.19	141.01	395.4	143.48	395.37	146	395.22
148.48	395.19	150.99	395.1	153.48	394.88	155.99	394.6	158.48	394.56
160.98	394.55	163.49	394.51	165.98	394.26	168.49	394.08	170.97	393.96
173.49	393.91	175.97	393.9	178.49	393.77	180.96	393.63	183.49	393.62
185.95	393.36	188.49	393.34	190.95	393.34	193.5	393.22	195.94	393.1
198.5	393.08	200.94	392.96	203.5	392.85	205.93	392.82	208.5	392.7
210.92	392.68	213.5	392.78	215.57	392.92	218.16	392.91	220.92	392.96
223.5	392.95	226.1	392.94	230.93	392.93	233.5	392.85	236.09	392.86
240.93	392.87	243.5	392.84	246.09	392.84	250.93	392.85	253.5	392.82
256.08	392.82	260.94	393.19	263.5	393.19	266.07	393.19	270.94	393.19
273.5	393.19	276.61	393.19	279.16	393.07	281.04	393.06	281.41	393.06
284.49	393.07	290.19	392.96	291.27	392.96	291.61	392.97	295.35	392.97
299.05	392.66	300	390	355	382	365	382	420	390
421.56	391.86	424.75	392	428.8	392.06	431.71	392.19	435.06	392.32
436.88	392.38	439.93	392.5	449.82	392.62	467.6	393.17	470.89	393.14
474.35	393.17	477.71	393.13	481.25	393.18	484.22	393.1	487.82	393.14
491.63	393.17	494.08	393.28	497.94	393.31	501.25	393.36	502.01	393.49
503.64	393.54	503.85	393.65	504.17	393.75	504.58	393.81	507.8	393.9
509.7	393.91	511.47	393.99	512.28	394.05	513.66	394.11	513.83	394.11
514.14	394.19	514.63	394.19	514.83	394.2	519.72	394.28	529.69	394.28
530.8	394.29	530.93	394.37	531.11	394.37	531.65	394.38	532.19	394.46
541.34	394.46	544.94	394.47	546.6	394.52	558.41	394.56	568.12	394.7
608.01	394.93	620.8	394.95	621.23	394.93	621.24	394.95	621.25	394.92
621.27	394.94	621.29	394.96	634.83	394.93	636.49	394.96	642.32	394.98
644.38	394.95	646.48	394.97	652.33	394.99	654.38	394.96	656.47	394.98
667.97	395	669.94	394.98	672	395	673.15	395.02	681.02	395
683.78	395.02	686.46	395.04	688.42	395.06	694.13	395.08	696.48	395.1
702.18	395.12	704.31	395.14	706.5	395.16	712.12	395.18	714.29	395.2
716.52	395.22	716.63	395.24	722.15	395.26	726.52	395.28	732.05	395.3
734.28	395.32	736.52	395.34	739.11	395.36	740	395.38	743.02	395.4
746.28	395.42	752.53	395.44	753.36	395.46	753.5	395.48	754.32	395.5
758.75	395.52	761.26	395.54	763.82	395.56	764.82	395.58	767.97	395.6
778.17	395.62	783.54	395.66	787.64	395.68	792.07	395.68	798	395.7

Bridge_Deck_Adjustm. rep									
798.49	395.71	799.3	395.73	806	395.73	808.54	395.75	817.06	395.76
818.55	395.77	819.99	395.78	827.3	395.8	829	395.8	835.88	395.82
836.19	395.83	841.57	395.84	847.39	395.85	853.97	395.87	855.39	395.87
855.93	395.89	856.3	395.89	856.57	395.91	856.61	395.92	856.71	395.93
856.76	395.94	856.81	395.96	856.87	395.96	856.99	395.98	857.82	395.99
857.94	396	866.95	396.01	874.06	396.03	880.54	396.03	881.67	396.05
883.15	396.06	887.72	396.08	893.96	396.08	898.23	396.1	903.39	396.11
906.94	396.12	912.43	396.13	919.06	396.15	919.93	396.15	926.64	396.17
932.92	396.18	933.74	396.2	934.73	396.21	940.84	396.23	945.91	396.23
947.94	396.25	950.4	396.26	955.05	396.28	958.89	396.29	962.15	396.31
965.99	396.31	968.48	396.33	968.96	396.34				

Manning's n Values num= 3  
 Sta n Val Sta n Val  
 0 .046 299.05 .035 421.56 .046

Bank Sta: Left Right Lengths: Left Channel Right Coeff Contr. Expan.  
 299.05 421.56 60 60 60 .3 .5  
 Left Levee Station= 141.41 Elevation= 395.42

CROSS SECTION

RIVER: Little Goldstream  
 REACH: Stream Centerline RS: 376.11

INPUT

Description: Downstream  
 Station Elevation Data

num= 209									
Sta	Elev	Sta	Elev	Sta	Elev	Sta	Elev	Sta	Elev
0	390.3	080017	390.187	869995	390.47	11.31	390.6716	08002	390.59
18.14001	390.5618	17004	390.5619	97003	390.6520	77002	390.7223	02002	390.72
25.37	390.69	29	390.6831	79999	390.6838	04004	390.6740	34003	390.66
52.20001	390.955	45001	390.9656	95001	390.98	58.37	391.0159	72003	391.03
70.65002	390.9371	47003	390.9472	23004	390.9572	96002	390.9685	71002	391.51
85.75	391.5185	78003	391.51	85.81	391.5199	04004	391.78	100.94	391.82
105.04	391.98	106.5	392.01	109.4	392.12	110.7	392.14	114.58	392.29
115.69	392.31	119.77	392.47	120.68	392.49	124.97	392.66	125.66	392.67
130.18	392.86	130.65	392.86	135.4	393.06	135.63	393.07	136.17	393.07
140.25	393.26	140.59	393.28	140.71	393.29	143.38	393.43	150.12	393.52
154.27	392.98	158.73	392.96	165.49	392.96	171.52	394.21	174.59	394.85
176.41	395.28	179.5	395.31	180.15	395.32	193.08	395.22	194.5	395.23
198.34	395.11	199.44	395.11	203.51	395.11	208.45	395.11	209.02	395.11
211.84	395.11	214.12	394.72	214.55	394.63	221.23	393.46	222.95	393.07
225.18	392.51	228.24	391.84	230.69	391.24	239.4	389.38	239.86	389.44
241.33	389.55	242.73	389.7	247.5	390.14	250.24	390.39	251.1	390.47
260.75	388.31	260.77	388.3	261.83	388	266.44	385.49	272.78	382.16
275.39	382.16	283	382.16	287.02	384.68	291.13	387.56	292.24	388.36
292.65	388.64	293.77	389.24	303.1	389.86	303.37	389.88	306.33	390.05
306.95	390.06	309.22	390.1	320.89	390.28	321.39	390.29	322.01	390.3
333.89	390.31	335.55	390.29	335.79	390.3	336.11	390.29	348.04	390.18
350.08	390.27	352.81	390.25	360.53	390.29	364.37	390.37	369.51	390.24
373.01	390.24	378.66	390.37	385.5	390.73	386.21	390.73	392.95	390.62
399.51	390.3	408.02	390.27	421.17	383.62	422.89	382.12	425.43	382.14
435.09	382.24	435.95	382.31	443.19	388.33	443.77	388.36	446.88	388.52
447.48	388.56	449.12	388.64	456.68	389.05	464.64	389.51	469.75	389.87
472.16	389.99	472.88	390.01	485.21	390.09	485.74	390.1	486.22	390.11
486.66	390.12	499.77	390.79	500	390.8	500.22	390.81513	4301	390.81
514.15	390.81	514.22	390.82	527.7	391.13	528.35	391.13528	5601	391.13
528.69	391.13	541.99	391.06	542.58	391.08	543.09	391.11	543.74	391.13
556.06	391.54	556.89	391.58	557.99	391.63	559.52	391.69566	1801	392.03
569.83	392.18	574.04	392.32	577.45	392.47	581.73	392.65	585.24	392.8
586.04	392.83	590.74	392.89	593	392.93	597.26	393	600.61	393.05



Bridge\_Deck\_Adjustm.rep

605.63	393.25	609.16	393.33	612.06	393.4	618.42	393.44	618.63	393.44
622.52	393.38	627.44	393.45	632.81	393.6	634.51	393.76	636.1801	393.74
642.8	393.8	648.77	393.85	654.19	393.94	662.72	394.09	675.06	394.93
675.9	394.98	676.69	395.04	677.13	395.06	677.14	395.06	677.53	395.06
687.89	395.08	696.35	395.19	697.11	395.2	699.92	395.25	706.37	395.37
709.3	395.43	717.35	395.6	721.15	395.56	729.37	395.36	733.98	395.16
736.18	395.19	738.86	395.24	744.62	395.27	748.89	395.33	752.81	395.38
758.29	395.5	759.71	395.52	762.7	395.77	766.06	396.32	770.99	396.94
773.36	397.23	781.05	397.83	783.16	397.79	785.08	398		

Manning's n Values num= 3  
 Sta n Val Sta n Val Sta n Val  
 0 .055 408.02 .035 443.19 .055

Bank Sta: Left Right Lengths: Left Channel Right Coeff Contr. Expan.  
 408.02 443.19 58.59 58.59 58.59 .2 .4  
 Ineffective Flow num= 1  
 Sta L Sta R Elev Permanent  
 250.24 320.89 390.31 T  
 Left Levee Station= 179.5 Elevation= 395.31

CROSS SECTION

RIVER: Little Goldstream  
 REACH: Stream Centerline RS: 317.52

INPUT

Description: Downstream

Station Elevation Data num= 266

Sta	Elev	Sta	Elev	Sta	Elev	Sta	Elev	Sta	Elev
0	390.2	050049	390.292	970032	390.3112	09003	390.714	14001	390.74
16.14001	390.7818	11005	390.8223	72003	390.9126	01001	390.9628	62006	391
31.04004	391.0533	53003	391.0936	05005	391.1438	45001	391.1841	07001	391.24
43.37006	391.2846	08002	391.3348	30005	391.3751	09003	391.4265	71002	391.77
65.76001	391.7765	77002	391.7765	84003	391.7765	87006	391.7767	41003	391.76
79.43005	391.7179	55005	391.7180	17004	391.7280	54004	391.7393	14001	391.95
93.87006	391.9794	61005	391.9895	36005	391.9995	92004	392	103.29	392.3
114.82	392.21	120.26	392.36	121.61	392.4128	8701	392.64132	4301	392.75
142.4	393.03	145.1	393.08	157.73	393.24	158.29	393.23	161.7	393.18
171.89	392.98	172.23	392.98	172.59	392.98	185.01	392.85	185.76	392.86
186.57	392.86187	4301	392.86	194.29	392.68198	7401	392.54	201.86	392.6
212.58	392.76	213.34	392.76	216.01	392.76	220.01	392.17223	2401	392.16
223.78	392.16	226.52	392.16	238.25	393.15	239.96	393.12	241.76	393.08
243.65	393.05	245.65	393.01253	9301	392.25	256.07	392.22	258.33	392.19
260.71	392.16	268	391.68271	4901	391.32	277	391.34	279.65	391.41
279.69	391.41	291.76	391.34	293.54	391.35	293.82	391.34	296.69	391.28
300.82	391.01	304.44	391.14	307.54	391.25	311.51	391.01	314.25	390.88
314.3701	390.88315	1201	390.89	319.34	390.69	320.3	390.7	324.3	390.53
326.21	390.45	327.51	390.46	333.06	390.53	334.29	390.59	335.52	390.65
340.71	390.71	343.06	390.73	344.13	390.78	353.1	390.81	353.35	390.82
353.79	390.82	353.95	390.81	355.81	391.1	359.5	391.6	364.22	391.51
365.08	391.5	369.79	391.41	374.58	391.32	375.06	391.31	376.7	391.33
380.15	391.08	380.75	391.03	385.51	390.66387	6801	390.45	391.57	390.13
393.38	389.86	396.72	389.57	400.16	389	405.06	388.19	406.03	388.02
406.84	387.88	411.39	387.23	411.84	387.18	414.3	386.91	427.52	384.02
429.56	381.39	431.66	379.05	437.88	381.22	438.52	381.48	439.5	383.91
455.71	389.61	473.01	390.03	473.76	390.06	474.6	390.09	474.62	390.09
474.76	390.1	488.4	389.89	488.83	389.9	489.27	389.92	489.7	389.93
501.3	390.17	503.85	390.26	507.51	390.27	509.96	390.29	511.36	390.31
513.76	390.32	516.4	390.36	518.7	390.38521	4401	390.42	523.63	390.43
526.48	390.47528	5601	390.49	531.53	390.53	533.48	390.54	536.58	390.59
538.39	390.6	541.63	390.66	543.3	390.67546	6901	390.72	548.2	390.73

Bridge\_Deck\_Adjustm. rep

551.76	390.79	552.68	01	390.81	554.14	390.82	555.21	390.86	561.79	390.98		
563.02	391.02	566.81	01	391.09	568.01	391.14	571.82	01	391.21	572.99	391.25	
576.84	391.32	577.98		391.36	581.85	391.43	582.97		391.47	583.61	391.48	
584.67	391.52	591.87		391.91	592.95	391.95	596.88		392.17	597.94	01	392.2
601.89	392.42	602.93	01	392.46	606.89	392.67	607.92		392.71	611.9		392.93
612.63	392.95	613.35		392.99	616.59	393.25	623.11		393.75	626.42		394
629.55	394.24	634.77		394.5	636.39	394.62	646.8		394.18	647.57	01	394.15
650.23	394.18	658.44	01	394.27	672.35	394.21	672.91		394.21	673.27		394.22
673.56	01	394.22	680.24	394.49	684.2	394.51	688.56	01	394.52	689.98		394.54
694.73	394.56	695.67		394.61	700.36	394.61	700.41		394.61	705.28		394.61
707.27	394.61	710.1		394.64	710.44	01	394.65	715.34	394.72	719.87		394.78
721.36	394.79	725.99		394.85	730.27	394.91	734.23		394.96	737.32		394.98
741.31	01	395.03	745.01	395.08	751.06	01	395.15	755.81	01	395.14	756.41	395.16
759.63	395.25	762.81	01	395.34	768.19	01	395.41	771.22	395.49	774.21		395.58
777.16	395.66	783.18	01	396.17	785.96	396.25	788.69		396.33	791.39		396.41
794.94	396.57	798.5		396.67	802.72	396.82	806.2		396.92	812.06	01	397.09
813.06	01	397.18	17.68	01	396.86	821	396.89	824.31	01	396.93	827.6	396.97
832.57	396.91	835.75		396.95	838.91	396.98	842.06	01	397.02	847.43	01	396.95
850.45	396.98	853.46		397.01	859.4	397.31	864.06	01	397.36	865.09		397.37
868.1	397.39	871.45		397.42	874.46	397.36	878.49	01	397.4	881.4		397.48
885.24	01	397.51	889.41	397.55	893.95	397.59	895.53		397.59	897.83		397.61
903.59	398											

Manning's n Values	num=	3
Sta n Val Sta	n Val Sta n Val	
0 .055 414.3	.035 455.71 .055	

Bank Sta: Left	Right	Lengths: Left	Channel	Right	Coeff	Contr.	Expan.
414.3	455.71	57.7	57.7	57.7	.1	.3	
Left Levee	Station=	238.31	Elevation=	393.19			
Right Levee	Station=	636.62	Elevation=	394.66			

CROSS SECTION

RIVER: Little Goldstream  
 REACH: Stream Centerline RS: 259.82

INPUT

Description: Downstream  
 Station Elevation Data

Sta	El ev	Sta	El ev	Sta	El ev	Sta	El ev	Sta	El ev					
0	3904.96	0022	390.23	6.72	998	390.32	12.06	390.416	45001	390.3				
19.16	998	390.24	22.47	998	390.41	28.06	390.73	29.60	999	390.76				
38.03	998	390.78	42.56		390.81	42.79	999	390.81	42.91	998	390.81	48.35	999	390.8
51.35	999	390.86	53.84	998	390.87	58.31	390.98	59.59	998	391.03	60.13	391.04		
66.82	001	391.27	70.29	999	391.38	74.02	997	391.58	0.46	997	391.78	1.23	999	391.72
83.08	002	391.77	86.27	002	391.84	91.96	997	391.97	94.98	999	392.04	100.4	392.2	
103.58	392.28	107.91	392.23	110.06	392.28	112.2	392.34	114.32	392.39					
122.01	392.76	124.45	392.82	124.79	392.83	129.29	392.89	136.28	392.81					
138.95	392.85	141.61	392.88	144.27	392.91	150.67	393.11	153.54	393.14					
156.39	393.18	162.13	393.24	165.16	393.28	167.34	393.31	172.2	393.18					
180.32	392.87	194.7	392.57	196.03	392.51	210.62	392.63	211	392.63					
211.46	392.57	218.1	391.84	223.56	391.61	226	391.48	227.3	391.36					
230.44	391.07	237.02	390.54	237.75	390.46	242.92	389.86	248.69	389.53					
251.9	389.35	255.52	389.28	261.79	389.1	264.2	389.05	267.29	388.9					
274.59	388.93	274.81	388.92	274.99	388.93	275.1	388.94	275.93	388.94					
278.08	388.92	287.71	388.91	289.26	388.91	291.4	388.94	298.17	389.11					
298.7	389.12	310.18	389.1	310.76	389.11	311.43	389.13	312.73	389.16					
320.18	389.5	321.11	389.5	329.65	389.56	332.67	389.56	333.26	389.57					
334.94	389.59	345.09	389.87	346.27	389.89	346.39	389.89	348.19	389.99					
360.52	391.16	360.84	391.18	361.74	391.2	368.04	391.08	374.07	391.42					
375.2	391.49	377.86	391.27	378.38	391.23	389.98	390.36	404.9	382.79					

Bridge\_Deck\_Adjustm. rep

407.24	381.58	408.71	381.19	409.96	380.62	411.3	380.16	413.29	379.47
416.67	383.16	417.59	383.99	418.97	384.41	431.05	389.28	445.8	391.99
447.31	392.24	447.55	392.24	453.37	391.68	456.47	391.66	459.59	391.65
465.05	391.59	468.06	391.57	471.08	391.56	474.11	391.54	477.23	391.21
483.51	391.19	486.91	391	488.19	391.02	496.31	391.12	498.59	391.29
507.13	391.32	513	391.34	513.45	391.34	520.99	390.04	525.13	388.76
531.7	388.05	540.2	387.59	549.18	389.04	553.44	389.63	556.09	389.79
560.52	389.79	565.36	390.2	567.6	390.88	569.66	390.64	574.68	391.05
580.14	391.61	581.76	391.76	583.48	391.79	592.18	391.72	594.43	391.92
602.6	392.56	607.86	392.99	611.14	393.26	613.07	393.39	617.08	393.67
625.17	394.22	635.19	394.48	641.38	394.61	643.87	394.64	646.96	394.7
650.32	394.66	656.53	394.68	664.68	394.74	666.69	394.72	668.88	394.73
673.76	394.67	678.25	394.73	680.84	394.72	683.66	395	687.92	395.16
691.82	394.99	695	394.74	698.45	394.86	702.07	394.91	705.4	395
709.15	395	713.24	395.13	716.23	395.22	718.97	395.15	723.31	395.03
728.03	394.85	730.38	394.74	732.54	394.76	737.46	394.71	742.82	394.95
744.54	394.97	746.12	394.96	751.62	394.77	757.61	394.88	759.26	394.89
759.75	394.88	760.82	394.87	769.65	394.76	773.63	394.75	776.66	394.74
779.45	394.94	781.86	395.03	786.98	395.32	789.81	395.48	799.94	396.04
800.42	396.06	801.16	396.11	801.97	396.17	813.99	396.97	816.76	397.19
827.56	398								

Manning's n Values	num=	3
Sta n Val	Sta n Val	Sta n Val
0 .055	389.98	.035 431.05 .055

Bank Sta: Left	Right	Lengths: Left Channel	Right	Coeff Contr.	Expan.
389.98	431.05	78.37	78.37	.1	.3
Left Levee	Station=	166.76	Elevation=	393.31	

CROSS SECTION

RIVER: Little Goldstrea  
 REACH: Stream Centerlin RS: 181.45

INPUT

Description: Most Downstream Cross Section

Station	Elevation	Data	num=	233									
Sta	Elev	Sta	Elev	Sta	Elev	Sta	Elev	Sta	Elev				
0	3902.58	0017	390.149	110046	390.58	13.65	0002	390.617	68005	390.62			
27.55	005	390.66	28.59	0003	390.67	28.75	390.6729	41003	390.6731	06006	390.66		
37.01	001	390.58	41.33	0002	390.644	17004	390.5948	10004	390.6251	33002	390.63		
53.68	005	390.71	58.49	0005	390.83	65.13	391.0765	65002	391.0766	03003	391.08		
72.81	006	391.17	78.38		391.2779	97003	391.2882	17004	391.2387	14001	391.16		
90.73	004	391.28	94.30	0005	391.48	99.21	0002	391.5	101.46	391.53	103.08	391.53	
113.28		391.89	115.43	001	391.97	115.78		391.98	116.25	391.98	122.94	392.03	
127.78		392.07	130.1		392.13	133.29		392.23	137.26	392.37	140.13	392.44	
144.42		392.52	150.33		392.61	151.58		392.64	152.49	01	392.66	392.66	
164.84		392.71	165.9		392.74	167.37	01	392.75	173.06	01	392.8	177.19	392.94
180.22		392.98	184.41		393.32	187.38		393.5	189.54	393.55	194.54	393.43	
201.45		393.62	201.7		393.62	201.89		393.63	208.86	394.01	214.24	01	394.1
216.02		394.08	219.3		393.9	223.46		393.74	234.1	393.31	235.06	01	393.4
251.29		394.49	252.56	01	394.46	263.64		394.58	267.08	394.65	267.67		394.64
278.39		395.08	280.72		395.24	282.6		395.36	284.8	395.51	294.6		395.76
296.37	01	396.02	298.42		396.12	302.25		396.32	302.56	396.33	304.06		396.36
307.01		396.52	312.83		396.8	315.48		396.69	320.36	396.79	322.14		396.69
326.09		396.74	327.53		396.64	328.8		396.55	329.85	396.55	333.51		396.27
336.6		396.13	341.81		395.78	342.08		395.77	343.17	395.69	348.25		395.19
359.78		393.84	360.23		393.77	360.64		393.73	360.87	393.7	368.35		392.15
370.59		391.89	371.26		391.81	371.8		391.77	380.14	391.43	380.67		391.39
381.61		391.32	383.27		391.2	386.1		391	387.65	390.88	393.2		389.93
393.37		389.92	396.52		389.75	401.15		389.77	402.94	389.65	405.07		389.52

Bridge\_Deck\_Adjustm. rep

405.73	389.47	411.8	389.08	412.21	389.05	414.74	388.88	416.72	388.67
416.93	388.66	417.1	388.66	420.78	388.49	438.79	378.76	439.1	378.83
439.26	378.93	439.28	378.94	439.36	378.97	439.38	378.98	439.54	379.04
439.74	379.12	439.78	379.14	440.01	379.23	440.11	379.29	440.4	379.46
440.45	379.49	440.48	379.51	453.46	387.32	454.73	388.08	454.8	388.09
456.61	388.36	466.2	389.39	467.4	389.53	467.57	389.55	474.66	389.81
480.85	390.38	482.47	390.39	483.72	390.36	493.02	390.16	495.17	390.49
499.43	391.16	502.16	391.45	504.39	391.69	515.67	392.78	520.29	393.34
520.79	393.3	524.35	393.1	527.36	393.03	531.52	392.77	537.34	392.45
538.6901	392.46	539.65	392.53	545.85	392.91551.9401	551.9401	393.15	553.49	393.34
554.54	393.32561.7401	561.7401	393.62	564.71	393.68	572.21	393.83	578.12	394.02
579.0601	394.02	584.77	394.08	589.26	394	590.59	393.99592.9901	592.9901	393.96
599.32	393.87603.5601	603.5601	393.83	607.14	393.79609.3101	609.3101	393.83	610.22	393.85
615.38	393.94	619.01	394.01	623.95	394.19	626.25	394.24	628.77	394.3
637.66	394.78	638.16	394.79	638.51	394.8	640.55	394.76	646.21	394.34
650.26	394.32	653.38	394.24	657.76	394.25	660.55	394.22	662.54	394.24
670.42	394.01	674.55	393.72	676.37	393.59	679.72	393.64	681.77	393.7
692.23	393.91	707.58	394.2	710.73	394.31	711.7	394.38	717.55	394.51
723.72	394.68	724.66	394.7	730.41	394.75	730.96	394.75	735.26	394.89
735.82	394.9	735.91	394.9	741.07	395.02	745.42	395.12	749.15	395.21
752.04	395.38756.1201	756.1201	395.49	759.35	395.57	762.84	395.67	765.82	395.75
772.28	395.83774.7401	774.7401	395.9	774.86	395.9	775.88	395.93	785.78	396.48
787.5	396.54789.1201	789.1201	396.58	790.63	396.63	799.59	397.05	801.59	397.11
809.8	397.96810.3101	810.3101	397.98	810.78	398				

Manning's n Values	num=	3
Sta n Val	Sta n Val	Sta n Val
0 .055	420.78	.035 454.73 .055

Bank Sta: Left	Right	Lengths: Left Channel	Right	Coeff Contr.	Expan.
420.78	454.73	0	0	.1	.3
Left Levee	Station=	320.36	Elevation=	396.79	
Right Levee	Station=	637.66	Elevation=	394.78	

SUMMARY OF MANNING'S N VALUES

River: Little Goldstrea

Reach	River Sta.	n1	n2	n3
Stream Centerlin	640.59	.055	.035	.055
Stream Centerlin	583.05	.055	.035	.055
Stream Centerlin	527.1	.055	.035	.046
Stream Centerlin	497.46	.046	.035	.046
Stream Centerlin	450	Bridge		
Stream Centerlin	434.05	.046	.035	.046
Stream Centerlin	376.11	.055	.035	.055
Stream Centerlin	317.52	.055	.035	.055
Stream Centerlin	259.82	.055	.035	.055
Stream Centerlin	181.45	.055	.035	.055

SUMMARY OF REACH LENGTHS

River: Little Goldstrea

Reach	River Sta.	Left	Channel	Right
Stream Centerlin	640.59	57.54	57.54	57.54

		Bri dge_Deck_Adj ustm. rep		
Stream Centerlin	583.05	55.95	55.95	55.95
Stream Centerlin	527.1	272.34	272.34	272.34
Stream Centerlin	497.46	63.41	63.41	63.41
Stream Centerlin	450	Bri dge		
Stream Centerlin	434.05	60	60	60
Stream Centerlin	376.11	58.59	58.59	58.59
Stream Centerlin	317.52	57.7	57.7	57.7
Stream Centerlin	259.82	78.37	78.37	78.37
Stream Centerlin	181.45	0	0	0

SUMMARY OF CONTRACTION AND EXPANSION COEFFICIENTS  
River: Li ttle Goldstrea

Reach	Ri ver Sta.	Contr.	Expan.
Stream Centerlin	640.59	.1	.3
Stream Centerlin	583.05	.1	.3
Stream Centerlin	527.1	.2	.4
Stream Centerlin	497.46	.3	.5
Stream Centerlin	450	Bri dge	
Stream Centerlin	434.05	.3	.5
Stream Centerlin	376.11	.2	.4
Stream Centerlin	317.52	.1	.3
Stream Centerlin	259.82	.1	.3
Stream Centerlin	181.45	.1	.3

Bridge\_Deck\_Adjustm.rep

HEC-RAS Version 4.1.0 Jan 2010  
U.S. Army Corps of Engineers  
Hydrologic Engineering Center  
609 Second Street  
Davis, California

```
X      X  XXXXXX      XXXX      XXXX      XX      XXXX
X      X  X          X      X      X  X      X
X      X  X          X      X      X  X      X
XXXXXXXX XXXX      X      XXX XXXX      XXXXXX      XXXX
X      X  X          X      X      X  X      X
X      X  X          X      X      X  X      X
X      X  XXXXXX      XXXX      X  X      X  X      XXXXX
```

PROJECT DATA

Project Title: Bridge\_Deck\_Adjustment  
Project File : Bridge\_Deck\_Adjustm.prj  
Run Date and Time: 3/16/2016 5:16:52 PM

Project in English units

Project Description:  
ADOT&PF Parks Highway MP 305-325 Reconstruction  
Project 148830

Survey

points were collected between September 9, 2015 and November 19, 2015 by Design Alaska, Inc. and managed by William Kinne, PLS. All work was conducted with RTK GPS. Coordinates were translated to "Fairbanks 05-15-15". Elevations were calculated using the Geoid 12B model, NAVD88 datum. Two benchmarks set at the Little Goldstream Creek Bridge were established with differential levels from a primary control monument.

PLAN DATA

Plan Title: Final\_Deck\_120ft  
Plan File : t:\AKDOT\148830 - DOT&PF Parks 305-325 PI\03 Engineering\Hydrology and Hydraulics\HEC-RAS Model\HECRAS\030416\_Scour\_Analysi s\Bridge\_Deck\_Adjustm.p23

Geometry Title: Bridge\_Deck\_120ft  
Geometry File : t:\AKDOT\148830 - DOT&PF Parks 305-325 PI\03 Engineering\Hydrology and Hydraulics\HEC-RAS Model\HECRAS\030416\_Scour\_Analysi s\Bridge\_Deck\_Adjustm.g05

Flow Title : Steady\_USGS\_2003  
Flow File : t:\AKDOT\148830 - DOT&PF Parks 305-325 PI\03 Engineering\Hydrology and Hydraulics\HEC-RAS Model\HECRAS\030416\_Scour\_Analysi s\Bridge\_Deck\_Adjustm.f04

Plan Summary Information:

Number of:	Cross Sections	=	9	Multiple Openings	=	0
	Culverts	=	0	Inline Structures	=	0
	Bridges	=	1	Lateral Structures	=	0

Bridge\_Deck\_Adjustm.rep

Computational Information

Water surface calculation tolerance = 0.01  
 Critical depth calculation tolerance = 0.01  
 Maximum number of iterations = 20  
 Maximum difference tolerance = 0.3  
 Flow tolerance factor = 0.001

Computation Options

Critical depth computed only where necessary  
 Conveyance Calculation Method: At breaks in n values only  
 Friction Slope Method: Average Conveyance  
 Computational Flow Regime: Subcritical Flow

FLOW DATA

Flow Title: Steady\_USGS\_2003

Flow File : t:\AKDOT\148830 - DOT&PF Parks 305-325 PI\03 Engineering\Hydrology and  
 Hydraulics\HEC-RAS Model\HECRAS\030416\_Scour\_Analyses\Bridge\_Deck\_Adjustm.f04

Flow Data (cfs)

River	Reach	RS	Q100	Q500
Little Goldstream	Stream Centerline	640.59	1555	2162

Boundary Conditions

River	Reach	Profile	Upstream
Downstream			

Little Goldstream Centerline Q100  
 Normal S = 0.0005  
 Little Goldstream Centerline Q500  
 Normal S = 0.0005

GEOMETRY DATA

Geometry Title: Bridge\_Deck\_120ft

Geometry File : t:\AKDOT\148830 - DOT&PF Parks 305-325 PI\03 Engineering\Hydrology  
 and Hydraulics\HEC-RAS Model\HECRAS\030416\_Scour\_Analyses\Bridge\_Deck\_Adjustm.g05

CROSS SECTION

RIVER: Little Goldstream  
 REACH: Stream Centerline RS: 640.59

INPUT

Description: Most Upstream Cross Section

Station	Elevation	Data	num=	251	Station	Elevation	Station	Elevation	Station	Elevation
0	393.051	580017	392.94	6.01001	393.096	679993	393.041	11.41003	393.17	
15.91003	393.281	6.58002	393.262	1.23004	393.372	2.28003	393.382	6.96002	393.49	



Bridge\_Deck\_Adjustm. rep

31.48999	393.6	35.87	393.737	66003	393.6942	05005	393.7949	92999	393.96
50.42004	393.9552	96002	393.956	98004	393.85	61.13	393.865	42004	393.74
67.61005	393.83	71.75	393.76	76.06	393.6980	53003	393.62	81.44	393.55
86.13	393.4987	07001	393.4391	67004	393.3792	53003	393.35	101.45	393.24
107.59	393.98	107.89	393.98	107.91	393.98	108.41	393.93	108.79	393.9
123.93	392.54	124.69	392.52	125.07	392.51	132.31	392.3	133.46	392.27
137.74	392.17	140.36	392.1	143.04	392.04	145.37	392.14	151.24	392.86
155.12	393.25	156.32	393.37	159.26	393.7	162.89	393.64	165.44	393.77
173.62	393.14	175.87	393.2	177.88	393.26	185.58	394.32	186.33	394.35
186.99	394.38	193.59	394.91	194.51	394.98	197.85	395.16	203.88	395.39
206.51	395.49	210.97	395.66	215.07	395.68	216.58	395.74	222.32	395.78
223.39	395.79	230.75	395.7	236.71	395.63	237.75	395.55	241.72	395.5
249.68	395.42	249.94	395.42	250.05	395.42	250.31	395.42	250.69	395.42
250.83	395.42	252.75	395.39	253.29	395.44	257.97	395.38	262.78	395.31
267.71	395.24	272.78	395.17	272.79	395.18	281.73	396.64	283.32	396.48
286.74	396.39	287.31	396.41	291.18	395.71	297.17	394.47	297.4	394.5
298.32	394.5	307.48	393.43	309.89	393.35	317.56	393.62	321.47	393.38
327.65	393.28	333.04	393.03	337.73	392.97	341.35	392.31	347.93	391.53
350.96	391.29	351.69	391.37	353.08	391.21	358.44	390.62	361.03	390.32
361.34	390.3	375.39	383.74	379.38	383.3	385.48	383	392.2	382.67
396.36	384.07	414.75	395.89	415.47	396.29	415.56	396.32	421.95	396.59
422.96	396.64	424.32	396.7	428.36	396.93	431.42	397.01	436.65	396.81
442.67	396.82	442.74	396.82	442.84	396.82	447.47	396.61	449.9	396.53
452.8	396.52	453.68	396.48	457.9	396.48	462.57	396.48	462.66	396.48
467.25	396.39	471.24	396.32	472.91	396.08	473.45	396.04	477.99	395.85
478.87	395.78	483.05	395.59	484.32	395.47	489.85	395.35	491.29	395.19
492.26	395.07	500.67	393.99	503.9	393.83	508.02	393.63	513.96	393.22
515.35	393.2	520.29	393.135	22.0601	393.11	525.78	393.1	531	393.03
533.39	393.2	538.08	393.55	539.04	393.58	542.75	393.9	543.49	393.9
544.72	393.91	544.82	393.92	552.96	393.8	553.28	393.81	553.84	393.83
561.78	394.045	561.9401	394.09	563.01	394.19	563.79	394.17	570.23	394.47
573.74	394.655	576.1901	394.785	578.8101	394.91	587.9	395.11	588.65	395.14
589.88	395.17	591.02	395.07	595.3	394.85	601.29	394.91	606.7	394.85
612.24	394.75	616.66	394.77	619.98	394.78	629	394.87	632.74	394.88
639.6901	395.08	639.7	395.08	639.72	395.08	652.72	395.18	653.12	395.18
653.75	395.16	654.39	395.14	655.24	395.1656	4301	395.06	664.58	394.48
668.14	394.39	673.1	394.24	676.56	394.16	680.9	394.07	682.89	394.03
686.85	393.93	687.63	393.91	692.45	393.81	698.16	393.69	703.58	394.18
703.75	394.18	703.95	394.18	710.86	393.75	716.36	393.67	717.98	393.61
720.02	393.53	725.1	393.42	729.14	393.09	732.21	392.99	736.09	392.97
739.33	393.02	741.91	393.12	746.45	393.26	752.15	393.14	754.49	393.15
754.63	393.15	755.65	393.19	760.47	393.35	767.3	393.58	777.03	394.13
779.6801	394.28	780.66	394.33	784.28	394.68	789.15	395.36	793.02	395.39
796.27	395.68	804.23	396.37	813.48	397.14	818.06	397.46	829.8	398.28
830.63	398.34	831.27	398.36	831.47	398.37	832.48	398.44	838.97	398.48
853.67	399.34	853.69	399.34	853.76	399.36	857.47	400.14	876.5	404.24
879.94	405.49	888.79	408.81	895.23	410.46	895.9	410.61	896.74	410.83
903.02	412.37	908.01	413.44	910.14	413.79	921.28	414.64	922.67	414.77
927.27	414.84								

Manning's n Values  
 Sta n Val Sta num= 3  
 0 .055 361.34 n Val Sta n Val  
 .035 415.56 .055

Bank Sta: Left Right Lengths: Left Channel Right Coeff Contr. Expan.  
 361.34 415.56 57.54 57.54 57.54 .1 .3  
 Left Levee Station= 281.73 Elevation= 396.641  
 Right Levee Station= 431.42 Elevation= 397.01

CROSS SECTION

RIVER: Little Goldstream

REACH: Stream Centerlin

RS: 583.05

INPUT

Description: Upstream

Station Elevation Data

num= 246

Sta	Elev	Sta	Elev	Sta	Elev	Sta	Elev	Sta	Elev
0	392.821	390015	392.78	2.01001	392.776	530029	392.896	790039	392.89
11.46002	393.0211	79999	393.0216	59003	393.1616	82001	393.1621	70001	393.29
21.94	393.326	85004	393.4426	85999	393.4426	90002	393.44	29.37	393.51
31.85999	393.5736	72003	393.6837	09003	393.6842	01001	393.7850	82001	393.98
51.37	393.9752	46002	393.9557	01001	393.8961	71002	393.8366	54999	393.76
67.10004	393.7871	85999	393.7176	79004	393.63	78.56	393.681	79004	393.54
81.84003	393.54	86.75	393.4486	89001	393.4491	72003	393.3591	92999	393.36
101.29	393.19	101.65	393.19	102.01	393.2	107.8	393.86	107.95	393.86
108.67	393.86	123.9	392.52	124.26	392.52	125.5	392.54	131.12	392.38
132.5	392.35	135.62	392.27	139.79	392.16	144.02	392.06	144.84	392.1
146.92	392.35	153.61	393.02	155.67	393.23	160.69	393.79	163.48	393.75
165.44	393.85	174.76	393.13	176.6	393.18	178.25	393.23	186.81	394.41
187.06	394.42	187.28	394.43	189.79	394.63	193.72	394.8	194.24	394.81
195.38	394.92	199.24	395.12	204.5	395.33	206.81	395.42	210.7	395.56
215.96	395.6	217.31	395.64	222.43	395.68	223.38	395.69	229.97	395.61
235.31	395.55	237.23	395.4	241	395.36	248.56	395.28	249.14	395.29
249.41	395.29	250	395.28	250.88	395.28	251.19	395.27	253.01	395.25
254.3	395.37	258.64	395.31	263.09	395.25	267.66	395.19	272.36	395.12
273.36	395.13	275.06	395.8	280.68	396.72	285.63	396.2	289.67	396.24
292.74	395.73	296.52	395.19	302.57	394.47	306.96	394.36	312.35	394.1
314.07	393.93	315.46	393.89	321.17	393.79	328.18	392.64	328.28	392.63
328.36	392.63	335.39	392.33	348.03	390.48	348.74	390.38	358.55	385.54
371.67	383.49	374.89	382.99	377.23	384.78	388.97	390.12	391.57	390.71
393.79	391.2	397.64	392.07	400.03	392.61	402.26	393.11	403.81	393.45
407.51	393.8	410.15	394.13	414.79	394.62	417.26	394.9	419.69	395.16
425.95	395.88	425.96	395.89	425.98	395.89	430.28	396.05	441.56	396.47
444.92	396.48	447.05	396.4	449.49	396.39	451.91	396.28	455.17	396.28
458.84	396.28	463.02	396.28	465.37	396.3	469.41	396.3	474.02	396.29
474.46	396.27	476.78	396.28	479.13	396.18	479.27	396.17	486.55	396.02
486.79	395.99	486.95	395.97	499.36	394.38	500.62	394.32	502.22	394.24
512.62	393.53	513.33	393.52	515.89	393.48	516.8	393.47	525.01	393.45
528.14	393.4	529.57	393.51	532.37	393.72	538.19	393.89	541.1	394.14
541.94	394.21	547.74	394.2	551.73	394.4	551.98	394.4	558.02	394.44
558.88	394.52	563.32	394.43	568.04	394.65	574.51	394.98	575.76	395.04
577.1	395.11	583.53	395.26	586.22	395.25	588.37	395.26	592.34	395.06
595.87	395.09	604.63	394.99	613.65	394.83	614.4	394.84	614.96	394.84
627.5601	394.97	628.97	394.97	631.59	395.04	636.03	395.19	639.58	395.17
647.6	395.26	650.26	395.26	652.38	395.11659	4301	394.61	661.49	394.55
670.21	394.29	672.42	394.24	675.19	394.18	681.31	394.08	684.02	394.01
687.5	393.92	694.97	393.73	695.2	393.72	695.35	393.73	695.96	393.72
703.58	393.95	707.18	393.72	711.67	393.66	714.29	393.61	716.38	393.69
721.41	393.58	727.69	393.06	728.52	392.98	729.18	392.98	735.64	393.08
741.99	393.33	742.75	393.35	743.71	393.33	753.93	393.36	754.54	393.38
759.01	393.54	761.93	393.64	767.86	393.97	778.33	394.65	780.39	394.9
785.44	395.61	791.76	395.67	792.56	395.69	793.19	395.71	799.23	396.17
809.43	397.01	818.61	397.66	823.8	398.02	828.13	398.19	831.59	398.26
835.25	398.29	842.25	398.69	851.87	399.32	867.32	402.74	873.51	404.24
878.53	406.15	885.05	408.6	887.87	409.32	892.17	410.36	895.6	411.33
899.28	412.23	903.89	413.22	906.4	413.68	911.35	414.17	917.98	414.65
924.64	414.75								

Manning's n Values

num= 3

Sta	n Val	Sta	n Val	Sta	n Val
0	.055	348.74	.035	388.97	.055

Bank Sta: Left 348.74 Right 388.97 Lengths: Left Channel 55.95 Right Channel 55.95 Coeff Contr. .1 Expan. .3

Bridge\_Deck\_Adjustm.rep

Left Levee Station= 280.68 Elevation= 396.72  
 Right Levee Station= 441.56 Elevation= 396.47

CROSS SECTION

RIVER: Little Goldstream  
 REACH: Stream Centerline RS: 527.1

INPUT

Description: Upstream

Station	Elevation	Data	num=	239	Station	Elevation	Station	Elevation	Station	Elevation	
0	391.45	.0999			391.457	809998	391.629	019958	391.622	17999	391.91
22.77997	391.92	34.31			391.893	6.23999	391.89	39.94	391.474	6.84998	391.46
54.87	391.42	60.32996			391.416	9.78998	391.467	3.79999	391.688	4.70996	392.22
86.38995	392.23	99.88			392.57	100.22	392.57	100.59	392.58	111.14	392.58
114.28	392.61	114.33			392.61	114.38	392.61	114.44	392.61	128.09	392.98
128.35	392.98	129.47			392.92	141.17	393.36	144.4	393.68	151.21	394.18
153.65	394.39	153.69			394.39	159.04	394.95	160.67	395.15	167.11	395.49
167.3	395.5	169.05			395.61	173.15	395.74	176.41	395.69	176.67	395.68
179.37	395.64	183.48			395.52	188.7	395.52	188.72	395.52	188.74	395.54
190.99	395.56	192.38			395.56	198.3	395.55	200.17	395.52	202.96	395.49
207.21	395.44	211.24			395.4	213.78	395.36	218.74	395.3	220.99	395.16
224.75	394.94	230.15			395.01	233.55	394.84	234.3	394.57	236.53	394.45
236.93	394.42	240.18			394.31	243.62	394.09	245.8199	394.01	247.95	393.87
249.62	393.81	253.13			393.56	254.04	393.53	258.3	393.21	259.18	393.15
261.45	393.11	261.99			393.11	268.3	393.03	273.88	392.95	276.61	392.96
278.3	392.8	287.71			392.93	289.75	392.8	290.81	392.85	291.64	392.89
292.3	392.93	304.0699			392.83	305	392.87	308.53	393	312.34	393.11
314.54	393.12	321.6			393.22	322.59	393.22	330.87	393.23	331.61	393.23
333.29	393.22	341.62			393.23	343.23	393.23	351.63	393.24	353.17	393.23
361.63	393.24	363.11			393.24	371.64	393.25	373.16	393.25	376.72	392.81
376.95	392.83	376.99			392.84	383.02	394.52	383.22	394.4	386.35	392.53
387.5699	391.8	388.52			391.22	391.12	389.67	392.7599	388.69	393.12	388.47
401.17	383.86	402.25			382.52	405.79	382.69	413.0099	385.11	413.17	385.16
413.56	385.28	414.35			385.53	414.83	385.69	415.85	386.01	416.47	386.21
417.83	386.64	418.66			386.91	419.54	387.19	424.26	388.7	425	388.93
425.34	389.04	428.18			389.95	428.59	390.06	434.99	391.89	443.33	392.7
445.34	392.89	455.57			393.85	460.69	394.04	471.07	394.59	473.3	394.51
481.09	394.65	482.79			394.66	491.1	394.82	500.4	394.92	501.16	394.94
501.21	394.94	501.57			394.94	502	394.94	514.89	395.15	517.12	395.17
517.39	395.17	527.37			395.29	530.65	395.35	532.97	395.39	540.05	395.55
542.64	395.59	545.72			395.64	549.4299	395.7	553.17	395.72	556.85	395.79
561.27	395.87	565.67			395.95	566.4399	395.95	566.66	395.95	571.86	395.96
578.27	395.96	580.05			395.96	583.48	395.97	590.85	395.95	598.1899	395.92
602.09	396.05	608.72			396.03	611.38	395.93	619.12	395.9	622.5	395.99
629.76	395.96	634.24			396	637.99	395.99	640.64	395.96	643.25	395.94
650.66	395.67	652.8099			395.63	654.5599	395.6	656.01	395.58	667.02	395.55
667.63	395.54	668.14			395.53	674.0599	395.25	680.73	394.81	682.1	394.83
684.18	394.75	692.7			394.66	696.54	394.6	702.36	394.32	704.67	394.21
710.97	394	716.65			393.82	718.1899	393.82	720.54	393.75	725.41	393.6
728.62	393.53	732.63			393.46	738.72	393.32	739.85	393.3	740.86	393.29
741.46	393.3	751.49			393.43	754.1899	393.5	759.96	393.65	760.53	393.71
775.95	395.12	776.52			395.18	783.17	395.84	788.5	396.16	793.25	396.59
797.6	396.92	800.47			397.09	804.8199	397.05	810.93	397.15	815.89	396.99
822.27	397.73	826.48			398.13	829.61	397.93	833.7	397.74	836.39	397.91
840.92	398.33	847.79			398.55	848.14	398.55	848.37	398.56	860.96	399.22
862.52	399.27	877			403.05	881.2599	404.24	886.05	405.79	896.27	409.31
898.67	409.9	902.33			410.94	905.89	411.86	908.24	412.37	913.11	413.28
920.97	414.09	924.88			414.57	930.7599	414.66	931.6	414.67		

Manning's n Values

num= 3

Bridge\_Deck\_Adjustm.rep

Sta n Val Sta n Val Sta n Val  
 0 .055 386.35 .035 428.18 .046

Bank Sta: Left Right Lengths: Left Channel Right Coeff Contr. Expan.  
 386.35 428.18 272.34 272.34 272.34 .2 .4  
 Left Levee Station= 173.15 Elevation= 395.74  
 Right Levee Station= 608.72 Elevation= 396.03

CROSS SECTION

RIVER: Little Goldstream  
 REACH: Stream Centerline RS: 497.46

INPUT

Description: Upstream of Proposed Bridge  
 Station Elevation Data num= 201

Sta	Elev	Sta	Elev	Sta	Elev	Sta	Elev	Sta	Elev
0	393.73	8.43	393.5	8.59	393.5	8.72	393.5	8.84	393.5
8.96	393.49	11.96	393.39	22.02	393.24	24.2	393.24	34.97	393.5
39.95	393.57	44.6	394.05	45.76	394.05	57.22	393.75	58.22	393.74
58.86	393.74	60.46	393.75	72.57	393.71	73.36	393.71	84.66	393.6
86.87	393.6	86.94	393.6	87.01	393.6	100.18	393.54	100.66	393.55
101.14	393.55	101.64	393.55	113.78	393.76	114.62	393.76	118.7	393.88
122.12	394.18	124.04	394.2	135.94	394.03	136.97	394.03	137.17	394.03
150.47	393.85	150.88	393.85	151.3	393.85	157.36	393.91	164.88	394.04
165.46	394.04	178.1	394.27	179.61	394.28	190.7	394.33	192.99	394.33
195.4	394.34	205.28	394.56	211.08	394.57	215.21	394.58	221.1	394.59
225.14	394.6	231.13	394.61	241.9	394.77	243.04	394.77	244.25	394.77
256.11	394.7	256.55	394.7	258.37	394.7	268.52	394.76	271.61	394.77
274.75	394.77	281.21	394.63	284.87	394.62	291.22	394.63	294.85	394.62
301.22	394.62	304.83	394.61	311.23	394.62	312.36	394.61	314.42	394.61
320.86	394.62	331.73	394.64	334.48	394.64	337.28	394.65	346.85	394.79
350.45	394.8	351.32	394.8	354.04	394.79	361.46	394.63	364.29	394.61
370.92	394.6	372.61	394.59	374.3	394.58	380.91	394.56	382.61	394.55
384.32	394.55	395.63	394.1	397.82	394.09	399.97	394.09	410.08	394.39
413.09	394.38	416.03	394.37	425	390	457.62	390	480	382.54
490	382.54	512.38	390	545	390	546.58	393.23	548.87	393.78
550.07	393.79	550.4	393.79	559.53	393.79	561.33	393.78	566.8	393.78
612.68	393.77	615.89	393.78	622.63	393.77	625.89	393.78	632.57	393.77
635.9	393.78	637.37	393.78	643.99	393.77	645.9	393.77	651.57	393.69
655.31	393.67	661.72	393.48	661.93	393.47	661.98	393.47	665.36	393.49
675.62	393.56	676.06	393.56	676.48	393.56	688.59	393.38	689.98	393.52
694.01	393.5	698.6	393.56	703.81	393.63	706	393.62	708.57	393.66
713.3	393.75	713.76	393.75	715.24	393.78	718.13	393.98	718.64	394
721.56	394.19	722.61	394.23	727.52	394.54	729.37	394.6	729.97	394.64
731.26	394.71	732.42	395.12	734.65	395.24	743.52	395.11	746.53	395.3
748.33	395.41	752.31	395.45	757.2	395.53	760.39	395.57	763.75	395.6
765.96	395.63	770.46	395.7	775.08	395.7	776.16	395.71	781.18	395.67
781.24	395.63	781.27	395.61	785.95	395.62	794.71	395.86	795.26	395.87
795.31	395.87	795.98	395.88	796.81	395.85	797.17	395.83	797.21	395.83
799.26	395.72	808.48	395.26	811.9	394.9	811.96	394.89	815.55	394.59
823.44	394.01	824.14	393.96	824.18	393.96	824.6	393.94	824.89	393.94
837.49	393.43	838.69	393.41	839.8	393.4	852.13	393.13	853.65	393.11
865.29	393.09	867.18	393.07	868.95	393.05	880.44	392.76	885.11	392.73
891.47	392.41	900	391.94	904.96	391.91	914.9	391.94	918.45	391.95
929.79	391.97	931.01	392.11	931.64	392.11	945.02	392.14	945.25	392.14
952.78	391.96	958.99	391.85	959.19	391.85	959.39	391.85	959.44	391.85
967.8	391.75								

Manning's n Values num= 3  
 Sta n Val Sta n Val Sta n Val  
 0 .046 416.03 .035 548.87 .046

Bridge\_Deck\_Adjustm. rep

Bank Sta: Left Right Lengths: Left Channel Right Coeff Contr. Expan.  
 416.03 548.87 63.41 63.41 63.41 .3 .5  
 Left Levee Station= 408.87 Elevati on= 394.35  
 Right Levee Station= 734.65 Elevati on= 395.24

BRI DGE

RIVER: Little Goldstrea  
 REACH: Stream Centerlin RS: 450

INPUT

Description: Little Goldstream Bridge - Proposed  
 Distance from Upstream XS = 5  
 Deck/Roadway Width = 56  
 Weir Coefficient = 2.6

Upstream Deck/Roadway Coordinates

num= 4  

Sta	Hi Cord	Lo Cord	Sta	Hi Cord	Lo Cord	Sta	Hi Cord	Lo Cord
331.73	394.64		425	396.11	395.15	545	396.11	395.15
734.65	395.24							

Upstream Bridge Cross Section Data

Station Elevati on Data num= 201

Sta	Elev	Sta	Elev	Sta	Elev	Sta	Elev	Sta	Elev
0	393.73	8.43	393.5	8.59	393.5	8.72	393.5	8.84	393.5
8.96	393.49	11.96	393.39	22.02	393.24	24.2	393.24	34.97	393.5
39.95	393.57	44.6	394.05	45.76	394.05	57.22	393.75	58.22	393.74
58.86	393.74	60.46	393.75	72.57	393.71	73.36	393.71	84.66	393.6
86.87	393.6	86.94	393.6	87.01	393.6	100.18	393.54	100.66	393.55
101.14	393.55	101.64	393.55	113.78	393.76	114.62	393.76	118.7	393.88
122.12	394.18	124.04	394.2	135.94	394.03	136.97	394.03	137.17	394.03
150.47	393.85	150.88	393.85	151.3	393.85	157.36	393.91	164.88	394.04
165.46	394.04	178.1	394.27	179.61	394.28	190.7	394.33	192.99	394.33
195.4	394.34	205.28	394.56	211.08	394.57	215.21	394.58	221.1	394.59
225.14	394.6	231.13	394.61	241.9	394.77	243.04	394.77	244.25	394.77
256.11	394.7	256.55	394.7	258.37	394.7	268.52	394.76	271.61	394.77
274.75	394.77	281.21	394.63	284.87	394.62	291.22	394.63	294.85	394.62
301.22	394.62	304.83	394.61	311.23	394.62	312.36	394.61	314.42	394.61
320.86	394.62	331.73	394.64	334.48	394.64	337.28	394.65	346.85	394.79
350.45	394.8	351.32	394.8	354.04	394.79	361.46	394.63	364.29	394.61
370.92	394.6	372.61	394.59	374.3	394.58	380.91	394.56	382.61	394.55
384.32	394.55	395.63	394.1	397.82	394.09	399.97	394.09	410.08	394.39
413.09	394.38	416.03	394.37	425	390	457.62	390	480	382.54
490	382.54	512.38	390	545	390	546.58	393.23	548.87	393.78
550.07	393.79	550.4	393.79	559.53	393.79	561.33	393.78	566.8	393.78
612.68	393.77	615.89	393.78	622.63	393.77	625.89	393.78	632.57	393.77
635.9	393.78	637.37	393.78	643.99	393.77	645.9	393.77	651.57	393.69
655.31	393.67	661.72	393.48	661.93	393.47	661.98	393.47	665.36	393.49
675.62	393.56	676.06	393.56	676.48	393.56	688.59	393.38	689.98	393.52
694.01	393.5	698.6	393.56	703.81	393.63	706	393.62	708.57	393.66
713.3	393.75	713.76	393.75	715.24	393.78	718.13	393.98	718.64	394
721.56	394.19	722.61	394.23	727.52	394.54	729.37	394.6	729.97	394.64
731.26	394.71	732.42	395.12	734.65	395.24	743.52	395.11	746.53	395.3
748.33	395.41	752.31	395.45	757.2	395.53	760.39	395.57	763.75	395.6
765.96	395.63	770.46	395.7	775.08	395.7	776.16	395.71	781.18	395.67
781.24	395.63	781.27	395.61	785.95	395.62	794.71	395.86	795.26	395.87
795.31	395.87	795.98	395.88	796.81	395.85	797.17	395.83	797.21	395.83
799.26	395.72	808.48	395.26	811.9	394.9	811.96	394.89	815.55	394.59
823.44	394.01	824.14	393.96	824.18	393.96	824.6	393.94	824.89	393.94
837.49	393.43	838.69	393.41	839.8	393.4	852.13	393.13	853.65	393.11
865.29	393.09	867.18	393.07	868.95	393.05	880.44	392.76	885.11	392.73

Bridge\_Deck\_Adjustm. rep

891.47	392.41	900	391.94	904.96	391.91	914.9	391.94	918.45	391.95
929.79	391.97	931.01	392.11	931.64	392.11	945.02	392.14	945.25	392.14
952.78	391.96	958.99	391.85	959.19	391.85	959.39	391.85	959.44	391.85
967.8	391.75								

Manning's n Values num= 3

Sta	n Val	Sta	n Val	Sta	n Val
0	.046	416.03	.035	548.87	.046

Bank Sta:	Left	Right	Coeff	Contr.	Expan.
	416.03	548.87	.3	.5	
Left Levee		Station=	408.87	Elevation=	394.35
Right Levee		Station=	734.65	Elevation=	395.24

Downstream Deck/Roadway Coordinates num= 4

Sta	Hi	Cord	Lo	Cord	Sta	Hi	Cord	Lo	Cord	Sta	Hi	Cord	Lo	Cord
150	393.96				300	396.11	395.15			420	396.11	395.15		
558.41	394.56													

Downstream Bridge Cross Section Data Station Elevation Data num= 275

Sta	Elev	Sta	Elev	Sta	Elev	Sta	Elev	Sta	Elev
0	395.47	.63	395.49	3.61	395.55	5.64	395.66	8.6	395.6
10.66	395.54	13.6	395.58	15.67	395.62	18.59	395.63	20.69	395.71
23.59	395.65	25.96	395.64	28.84	395.65	30.72	395.7	33.58	395.55
35.73	395.55	38.57	395.69	40.75	395.7	43.57	395.69	45.76	395.7
48.56	395.66	50.78	395.68	53.55	395.65	55.8	395.65	58.55	395.64
60.81	395.59	63.54	395.52	65.83	395.44	68.54	395.44	70.85	395.35
73.53	395.3	75.86	395.29	78.53	395.28	80.88	395.27	83.52	395.26
85.9	395.25	88.51	395.22	90.91	395.18	93.51	395.13	95.93	394.94
98.5	394.25	100.95	393.96	103.5	393.5	105.96	393.49	108.49	393.68
110.98	393.65	113.84	392.96	116.36	392.93	118.48	392.96	121	393.41
123.48	393.46	126.01	393.78	128.48	393.82	131.01	393.84	133.47	394.29
134	395.04	136.47	395.19	141.01	395.4	143.48	395.37	146	395.22
148.48	395.19	150.99	395.1	153.48	394.88	155.99	394.6	158.48	394.56
160.98	394.55	163.49	394.51	165.98	394.26	168.49	394.08	170.97	393.96
173.49	393.91	175.97	393.9	178.49	393.77	180.96	393.63	183.49	393.62
185.95	393.36	188.49	393.34	190.95	393.34	193.5	393.22	195.94	393.1
198.5	393.08	200.94	392.96	203.5	392.85	205.93	392.82	208.5	392.7
210.92	392.68	213.5	392.78	215.57	392.92	218.16	392.91	220.92	392.96
223.5	392.95	226.1	392.94	230.93	392.93	233.5	392.85	236.09	392.86
240.93	392.87	243.5	392.84	246.09	392.84	250.93	392.85	253.5	392.82
256.08	392.82	260.94	393.19	263.5	393.19	266.07	393.19	270.94	393.19
273.5	393.19	276.61	393.19	279.16	393.07	281.04	393.06	281.41	393.06
284.49	393.07	290.19	392.96	291.27	392.96	291.61	392.97	295.35	392.97
299.05	392.66	300	390	331	390	355	382	365	382
389	390	420	390	421.56	391.86	424.75	392	428.8	392.06
431.71	392.19	435.06	392.32	436.88	392.38	439.93	392.5	449.82	392.62
467.6	393.17	470.89	393.14	474.35	393.17	477.71	393.13	481.25	393.18
484.22	393.1	487.82	393.14	491.63	393.17	494.08	393.28	497.94	393.31
501.25	393.36	502.01	393.49	503.64	393.54	503.85	393.65	504.17	393.75
504.58	393.81	507.8	393.9	509.7	393.91	511.47	393.99	512.28	394.05
513.66	394.11	513.83	394.11	514.14	394.19	514.63	394.19	514.83	394.2
519.72	394.28	529.69	394.28	530.8	394.29	530.93	394.37	531.11	394.37
531.65	394.38	532.19	394.46	541.34	394.46	544.94	394.47	546.6	394.52
558.41	394.56	568.12	394.7	608.01	394.93	620.8	394.95	621.23	394.93
621.24	394.95	621.25	394.92	621.27	394.94	621.29	394.96	634.83	394.93
636.49	394.96	642.32	394.98	644.38	394.95	646.48	394.97	652.33	394.99
654.38	394.96	656.47	394.98	667.97	395	669.94	394.98	672	395
673.15	395.02	681.02	395	683.78	395.02	686.46	395.04	688.42	395.06
694.13	395.08	696.48	395.1	702.18	395.12	704.31	395.14	706.5	395.16
712.12	395.18	714.29	395.2	716.52	395.22	716.63	395.24	722.15	395.26

Bridge\_Deck\_Adjustm.rep

726.52	395.28	732.05	395.3	734.28	395.32	736.52	395.34	739.11	395.36
740	395.38	743.02	395.4	746.28	395.42	752.53	395.44	753.36	395.46
753.5	395.48	754.32	395.5	758.75	395.52	761.26	395.54	763.82	395.56
764.82	395.58	767.97	395.6	778.17	395.62	783.54	395.66	787.64	395.68
792.07	395.68	798	395.7	798.49	395.71	799.3	395.73	806	395.73
808.54	395.75	817.06	395.76	818.55	395.77	819.99	395.78	827.3	395.8
829	395.8	835.88	395.82	836.19	395.83	841.57	395.84	847.39	395.85
853.97	395.87	855.39	395.87	855.93	395.89	856.3	395.89	856.57	395.91
856.61	395.92	856.71	395.93	856.76	395.94	856.81	395.96	856.87	395.96
856.99	395.98	857.82	395.99	857.94	396	866.95	396.01	874.06	396.03
880.54	396.03	881.67	396.05	883.15	396.06	887.72	396.08	893.96	396.08
898.23	396.1	903.39	396.11	906.94	396.12	912.43	396.13	919.06	396.15
919.93	396.15	926.64	396.17	932.92	396.18	933.74	396.2	934.73	396.21
940.84	396.23	945.91	396.23	947.94	396.25	950.4	396.26	955.05	396.28
958.89	396.29	962.15	396.31	965.99	396.31	968.48	396.33	968.96	396.34

Manning's n Values num= 3  
 Sta n Val Sta n Val Sta n Val  
 0 .046 299.05 .035 421.56 .046

Bank Sta: Left Right Coeff Contr. Expan.  
 299.05 421.56 .3 .5  
 Left Levee Station= 141.01 Elevati on= 395.4  
 Right Levee Station= 570.27 Elevati on= 394.71

Upstream Embankment side slope = 0 horiz. to 1.0 vertical  
 Downstream Embankment side slope = 0 horiz. to 1.0 vertical  
 Maximum allowable submergence for weir flow = .98  
 Elevati on at which weir flow begins =  
 Energy head used in spillway design =  
 Spillway height used in design =  
 Weir crest shape = Broad Crested

Number of Bridge Coefficient Sets = 1

Low Flow Methods and Data  
 Energy  
 Selected Low Flow Methods = Highest Energy Answer

High Flow Method  
 Energy Only

Additional Bridge Parameters  
 Add Friction component to Momentum  
 Do not add Weight component to Momentum  
 Class B flow critical depth computations use critical depth  
 inside the bridge at the upstream end  
 Criteria to check for pressure flow = Upstream energy grade line

CROSS SECTION

RIVER: Little Goldstrea  
 REACH: Stream Centerlin RS: 434.05

INPUT  
 Description: Downstream of Proposed Bridge  
 Station Elevati on Data num= 275

Sta	Elev	Sta	Elev	Sta	Elev	Sta	Elev	Sta	Elev
0	395.47	.63	395.49	3.61	395.55	5.64	395.66	8.6	395.6
10.66	395.54	13.6	395.58	15.67	395.62	18.59	395.63	20.69	395.71
23.59	395.65	25.96	395.64	28.84	395.65	30.72	395.7	33.58	395.55
35.73	395.55	38.57	395.69	40.75	395.7	43.57	395.69	45.76	395.7



Bridge\_Deck\_Adjustm. rep

48.56	395.66	50.78	395.68	53.55	395.65	55.8	395.65	58.55	395.64
60.81	395.59	63.54	395.52	65.83	395.44	68.54	395.44	70.85	395.35
73.53	395.3	75.86	395.29	78.53	395.28	80.88	395.27	83.52	395.26
85.9	395.25	88.51	395.22	90.91	395.18	93.51	395.13	95.93	394.94
98.5	394.25	100.95	393.96	103.5	393.5	105.96	393.49	108.49	393.68
110.98	393.65	113.84	392.96	116.36	392.93	118.48	392.96	121	393.41
123.48	393.46	126.01	393.78	128.48	393.82	131.01	393.84	133.47	394.29
134	395.04	136.47	395.19	141.01	395.4	143.48	395.37	146	395.22
148.48	395.19	150.99	395.1	153.48	394.88	155.99	394.6	158.48	394.56
160.98	394.55	163.49	394.51	165.98	394.26	168.49	394.08	170.97	393.96
173.49	393.91	175.97	393.9	178.49	393.77	180.96	393.63	183.49	393.62
185.95	393.36	188.49	393.34	190.95	393.34	193.5	393.22	195.94	393.1
198.5	393.08	200.94	392.96	203.5	392.85	205.93	392.82	208.5	392.7
210.92	392.68	213.5	392.78	215.57	392.92	218.16	392.91	220.92	392.96
223.5	392.95	226.1	392.94	230.93	392.93	233.5	392.85	236.09	392.86
240.93	392.87	243.5	392.84	246.09	392.84	250.93	392.85	253.5	392.82
256.08	392.82	260.94	393.19	263.5	393.19	266.07	393.19	270.94	393.19
273.5	393.19	276.61	393.19	279.16	393.07	281.04	393.06	281.41	393.06
284.49	393.07	290.19	392.96	291.27	392.96	291.61	392.97	295.35	392.97
299.05	392.66	300	390	331	390	355	382	365	382
389	390	420	390	421.56	391.86	424.75	392	428.8	392.06
431.71	392.19	435.06	392.32	436.88	392.38	439.93	392.5	449.82	392.62
467.6	393.17	470.89	393.14	474.35	393.17	477.71	393.13	481.25	393.18
484.22	393.1	487.82	393.14	491.63	393.17	494.08	393.28	497.94	393.31
501.25	393.36	502.01	393.49	503.64	393.54	503.85	393.65	504.17	393.75
504.58	393.81	507.8	393.9	509.7	393.91	511.47	393.99	512.28	394.05
513.66	394.11	513.83	394.11	514.14	394.19	514.63	394.19	514.83	394.2
519.72	394.28	529.69	394.28	530.8	394.29	530.93	394.37	531.11	394.37
531.65	394.38	532.19	394.46	541.34	394.46	544.94	394.47	546.6	394.52
558.41	394.56	568.12	394.7	608.01	394.93	620.8	394.95	621.23	394.93
621.24	394.95	621.25	394.92	621.27	394.94	621.29	394.96	634.83	394.93
636.49	394.96	642.32	394.98	644.38	394.95	646.48	394.97	652.33	394.99
654.38	394.96	656.47	394.98	667.97	395	669.94	394.98	672	395
673.15	395.02	681.02	395	683.78	395.02	686.46	395.04	688.42	395.06
694.13	395.08	696.48	395.1	702.18	395.12	704.31	395.14	706.5	395.16
712.12	395.18	714.29	395.2	716.52	395.22	716.63	395.24	722.15	395.26
726.52	395.28	732.05	395.3	734.28	395.32	736.52	395.34	739.11	395.36
740	395.38	743.02	395.4	746.28	395.42	752.53	395.44	753.36	395.46
753.5	395.48	754.32	395.5	758.75	395.52	761.26	395.54	763.82	395.56
764.82	395.58	767.97	395.6	778.17	395.62	783.54	395.66	787.64	395.68
792.07	395.68	798	395.7	798.49	395.71	799.3	395.73	806	395.73
808.54	395.75	817.06	395.76	818.55	395.77	819.99	395.78	827.3	395.8
829	395.8	835.88	395.82	836.19	395.83	841.57	395.84	847.39	395.85
853.97	395.87	855.39	395.87	855.93	395.89	856.3	395.89	856.57	395.91
856.61	395.92	856.71	395.93	856.76	395.94	856.81	395.96	856.87	395.96
856.99	395.98	857.82	395.99	857.94	396	866.95	396.01	874.06	396.03
880.54	396.03	881.67	396.05	883.15	396.06	887.72	396.08	893.96	396.08
898.23	396.1	903.39	396.11	906.94	396.12	912.43	396.13	919.06	396.15
919.93	396.15	926.64	396.17	932.92	396.18	933.74	396.2	934.73	396.21
940.84	396.23	945.91	396.23	947.94	396.25	950.4	396.26	955.05	396.28
958.89	396.29	962.15	396.31	965.99	396.31	968.48	396.33	968.96	396.34

Manning's n Values	num=	3
Sta n Val	Sta n Val	Sta n Val
0 .046	299.05	.035 421.56 .046

Bank Sta: Left	Right	Lengths:	Left Channel	Right	Coeff	Contr.	Expan.
299.05	421.56		60 60	60		.3	.5
Left Levee	Station=	141.01	El evati on=	395.4			
Right Levee	Station=	570.27	El evati on=	394.71			

CROSS SECTION

Bridge\_Deck\_Adjustm.rep

RIVER: Little Goldstrea  
 REACH: Stream Centerlin

RS: 376.11

INPUT

Description: Downstream  
 Station Elevation Data

Sta	Elev	Sta	Elev	Sta	Elev	Sta	Elev	Sta	Elev
0	390.080017	390.187	869995	390.47	11.31	390.6716	08002	390.59	
18.14001	390.5618	17004	390.5619	97003	390.6520	77002	390.7223	02002	390.72
25.37	390.69	29	390.6831	79999	390.6838	04004	390.6740	34003	390.66
52.20001	390.955	45001	390.9656	95001	390.98	58.37	391.0159	72003	391.03
70.65002	390.9371	47003	390.9472	23004	390.9572	96002	390.9685	71002	391.51
85.75	391.5185	78003	391.51	85.81	391.5199	04004	391.78	100.94	391.82
105.04	391.98	106.5	392.01	109.4	392.12	110.7	392.14	114.58	392.29
115.69	392.31	119.77	392.47	120.68	392.49	124.97	392.66	125.66	392.67
130.18	392.86	130.65	392.86	135.4	393.06	135.63	393.07	136.17	393.07
140.25	393.26	140.59	393.28	140.71	393.29	143.38	393.43	150.12	393.52
154.27	392.98	158.73	392.96	165.49	392.96	171.52	394.21	174.59	394.85
176.41	395.28	179.5	395.31	180.15	395.32	193.08	395.22	194.5	395.23
198.34	395.11	199.44	395.11	203.51	395.11	208.45	395.11	209.02	395.11
211.84	395.11	214.12	394.72	214.55	394.63	221.23	393.46	222.95	393.07
225.18	392.51	228.24	391.84	230.69	391.24	239.4	389.38	239.86	389.44
241.33	389.55	242.73	389.7	247.5	390.14	250.24	390.39	251.1	390.47
260.75	388.31	260.77	388.3	261.83	388	266.44	385.49	272.78	382.16
275.39	382.16	283	382.16	287.02	384.68	291.13	387.56	292.24	388.36
292.65	388.64	293.77	389.24	303.1	389.86	303.37	389.88	306.33	390.05
306.95	390.06	309.22	390.1	320.89	390.28	321.39	390.29	322.01	390.3
333.89	390.31	335.55	390.29	335.79	390.3	336.11	390.29	348.04	390.18
350.08	390.27	352.81	390.25	360.53	390.29	364.37	390.37	369.51	390.24
373.01	390.24	378.66	390.37	385.5	390.73	386.21	390.73	392.95	390.62
399.51	390.3	408.02	390.27	421.17	383.62	422.89	382.12	425.43	382.14
435.09	382.24	435.95	382.31	443.19	388.33	443.77	388.36	446.88	388.52
447.48	388.56	449.12	388.64	456.68	389.05	464.64	389.51	469.75	389.87
472.16	389.99	472.88	390.01	485.21	390.09	485.74	390.1	486.22	390.11
486.66	390.12	499.77	390.79	500	390.8	500.22	390.81513	4301	390.81
514.15	390.81	514.22	390.82	527.7	391.13	528.35	391.13528	5601	391.13
528.69	391.13	541.99	391.06	542.58	391.08	543.09	391.11	543.74	391.13
556.06	391.54	556.89	391.58	557.99	391.63	559.52	391.69566	1801	392.03
569.83	392.18	574.04	392.32	577.45	392.47	581.73	392.65	585.24	392.8
586.04	392.83	590.74	392.89	593	392.93	597.26	393	600.61	393.05
605.63	393.25	609.16	393.33	612.06	393.4	618.42	393.44	618.63	393.44
622.52	393.38	627.44	393.45	632.81	393.6	634.51	393.7636	1801	393.74
642.8	393.8	648.77	393.85	654.19	393.94	662.72	394.09	675.06	394.93
675.9	394.98	676.69	395.04	677.13	395.06	677.14	395.06	677.53	395.06
687.89	395.08	696.35	395.19	697.11	395.2	699.92	395.25	706.37	395.37
709.3	395.43	717.35	395.6	721.15	395.56	729.37	395.36	733.98	395.16
736.18	395.19	738.86	395.24	744.62	395.27	748.89	395.33	752.81	395.38
758.29	395.5	759.71	395.52	762.7	395.77	766.06	396.32	770.99	396.94
773.36	397.23	781.05	397.83	783.16	397.79	785.08	398		

Station	Value	Station	Value	Station	Value
0	.055	408.02	.035	443.19	.055

Bank Sta:	Left	Right	Lengths:	Left Channel	Right	Coeff Contr.	Expan.
	408.02	443.19		58.59	58.59	.2	.4
Ineffective Flow	num= 1						
Station L	250.24	Station R	320.89	Elev	390.31		
Left Levee	Station=		179.5	Elevation=	395.31		

CROSS SECTION

Bridge\_Deck\_Adjustm. rep

RIVER: Little Goldstrea  
 REACH: Stream Centerlin RS: 317.52

INPUT

Description: Downstream  
 Station Elevation Data

Sta	Elev	Sta	Elev	Sta	Elev	Sta	Elev	Sta	Elev			
0	390.05	049	390.29	292.97	0032	390.31	112.09	0003	390.71	14.0001	390.74	
16.14	390.78	18.11	390.82	23.72	0003	390.91	26.01	0001	390.96	28.62	0006	391
31.04	391.05	33.53	391.09	36.05	0005	391.14	38.45	0001	391.18	41.07	0001	391.24
43.37	391.28	46.08	391.33	48.30	0005	391.37	51.09	0003	391.42	65.71	0002	391.77
65.76	391.77	65.77	391.77	65.84	0003	391.77	65.87	0006	391.77	67.41	0003	391.76
79.43	391.71	79.55	391.71	80.17	0004	391.72	80.54	0004	391.73	93.14	0001	391.95
93.87	391.97	94.61	391.98	95.36	0005	391.99	95.92	0004	392.10	3.29		392.3
114.82	392.21	120.26	392.36	121.61		392.41	28.87	0701	392.64	132.43	01	392.75
142.4	393.03	145.1	393.08	157.73		393.24	158.29		393.23	161.7		393.18
171.89	392.98	172.23	392.98	172.59		392.98	185.01		392.85	185.76		392.86
186.57	392.86	187.43	392.86	194.29		392.68	198.74	01	392.54	201.86		392.6
212.58	392.76	213.34	392.76	216.01		392.76	220.01		392.17	223.24	01	392.16
223.78	392.16	226.52	392.16	238.25		393.15	239.96		393.12	241.76		393.08
243.65	393.05	245.65	393.01	253.93	01	392.25	256.07		392.22	258.33		392.19
260.71	392.16	268	391.68	271.49	01	391.32	277		391.34	279.65		391.41
279.69	391.41	291.76	391.34	293.54		391.35	293.82		391.34	296.69		391.28
300.82	391.01	304.44	391.14	307.54		391.25	311.51		391.01	314.25		390.88
314.37	390.88	315.12	390.89	319.34		390.69	320.3		390.7	324.3		390.53
326.21	390.45	327.51	390.46	333.06		390.53	334.29		390.59	335.52		390.65
340.71	390.71	343.06	390.73	344.13		390.78	353.1		390.81	353.35		390.82
353.79	390.82	353.95	390.81	355.81		391.1	359.5		391.6	364.22		391.51
365.08	391.5	369.79	391.41	374.58		391.32	375.06		391.31	376.7		391.33
380.15	391.08	380.75	391.03	385.51		390.66	387.68	01	390.45	391.57		390.13
393.38	389.86	396.72	389.57	400.16		389	405.06		388.19	406.03		388.02
406.84	387.88	411.39	387.23	411.84		387.18	414.3		386.91	427.52		384.02
429.56	381.39	431.66	379.05	437.88		381.22	438.52		381.48	439.5		383.91
455.71	389.61	473.01	390.03	473.76		390.06	474.6		390.09	474.62		390.09
474.76	390.1	488.4	389.89	488.83		389.9	489.27		389.92	489.7		389.93
501.3	390.17	503.85	390.26	507.51		390.27	509.96		390.29	511.36		390.31
513.76	390.32	516.4	390.36	518.7		390.38	521.44	01	390.42	523.63		390.43
526.48	390.47	528.56	390.49	531.53		390.53	533.48		390.54	536.58		390.59
538.39	390.6	541.63	390.66	543.3		390.67	546.69	01	390.72	548.2		390.73
551.76	390.79	552.68	390.81	554.14		390.82	555.21		390.86	561.79		390.98
563.02	391.02	566.81	391.09	568.01		391.14	571.82	01	391.21	572.99		391.25
576.84	391.32	577.98	391.36	581.85		391.43	582.97		391.47	583.61		391.48
584.67	391.52	591.87	391.91	592.95		391.95	596.88		392.17	597.94	01	392.2
601.89	392.42	602.93	392.46	606.89		392.67	607.92		392.71	611.9		392.93
612.63	392.95	613.35	392.99	616.59		393.25	623.11		393.75	626.42		394
629.55	394.24	634.77	394.5	636.39		394.62	646.8		394.18	647.57	01	394.15
650.23	394.18	658.44	394.27	672.35		394.21	672.91		394.21	673.27		394.22
673.56	394.22	680.24	394.49	684.2		394.51	688.56	01	394.52	689.98		394.54
694.73	394.56	695.67	394.61	700.36		394.61	700.41		394.61	705.28		394.61
707.27	394.61	710.1	394.64	710.44	01	394.65	715.34		394.72	719.87		394.78
721.36	394.79	725.99	394.85	730.27		394.91	734.23		394.96	737.32		394.98
741.31	395.03	745.01	395.08	751.06	01	395.15	755.81	01	395.14	756.41		395.16
759.63	395.25	762.81	395.34	768.19	01	395.41	771.22		395.49	774.21		395.58
777.16	395.66	783.18	396.17	785.96		396.25	788.69		396.33	791.39		396.41
794.94	396.57	798.5	396.67	802.72		396.82	806.2		396.92	812.06	01	397.09
813.06	397.18	17.68	396.86	821		396.89	824.31	01	396.93	827.6		396.97
832.57	396.91	835.75	396.95	838.91		396.98	842.06	01	397.02	847.43	01	396.95
850.45	396.98	853.46	397.01	859.4		397.31	864.06	01	397.36	865.09		397.37
868.1	397.39	871.45	397.42	874.46		397.36	878.49	01	397.4	881.4		397.48
885.24	397.51	889.41	397.55	893.95		397.59	895.53		397.59	897.83		397.61
903.59	398											

Bridge\_Deck\_Adjustm.rep

Manning's n Values num= 3  
 Sta n Val Sta n Val  
 0 .055 414.3 .035 455.71 .055

Bank Sta: Left Right Lengths: Left Channel Right Coeff Contr. Expan.  
 414.3 455.71 57.7 57.7 57.7 .1 .3

CROSS SECTION

RIVER: Little Goldstream  
 REACH: Stream Centerline RS: 259.82

INPUT

Description: Downstream  
 Station Elevation Data

Sta	Elev	Sta	Elev	Sta	Elev	Sta	Elev	Sta	Elev		
0	3904.96	0022	390.23	6.72	998	390.32	12.06	390.416	45001	390.3	
19.16	390.24	22.47	390.41	28.06	390.73	29.60	390.74	32.82	001	390.76	
38.03	390.78	42.56	390.81	42.79	999	390.81	42.91	390.81	48.35	999	390.8
51.35	390.86	53.84	390.87	58.31	390.98	59.59	390.98	59.59	391.03	60.13	391.04
66.82	391.27	70.29	391.38	74.02	997	391.58	80.46	391.78	81.23	999	391.72
83.08	391.77	86.27	391.84	91.96	997	391.97	94.98	392.04	100.4	392.2	
103.58	392.28	107.91	392.23	110.06	392.28	112.2	392.34	114.32	392.39		
122.01	392.76	124.45	392.82	124.79	392.83	129.29	392.89	136.28	392.81		
138.95	392.85	141.61	392.88	144.27	392.91	150.67	393.11	153.54	393.14		
156.39	393.18	162.13	393.24	165.16	393.28	167.34	393.31	172.2	393.18		
180.32	392.87	194.7	392.57	196.03	392.51	210.62	392.63	211	392.63		
211.46	392.57	218.1	391.84	223.56	391.61	226	391.48	227.3	391.36		
230.44	391.07	237.02	390.54	237.75	390.46	242.92	389.86	248.69	389.53		
251.9	389.35	255.52	389.28	261.79	389.1	264.2	389.05	267.29	388.9		
274.59	388.93	274.81	388.92	274.99	388.93	275.1	388.94	275.93	388.94		
278.08	388.92	287.71	388.91	289.26	388.91	291.4	388.94	298.17	389.11		
298.7	389.12	310.18	389.1	310.76	389.11	311.43	389.13	312.73	389.16		
320.18	389.5	321.11	389.5	329.65	389.56	332.67	389.56	333.26	389.57		
334.94	389.59	345.09	389.87	346.27	389.89	346.39	389.89	348.19	389.99		
360.52	391.16	360.84	391.18	361.74	391.2	368.04	391.08	374.07	391.42		
375.2	391.49	377.86	391.27	378.38	391.23	389.98	390.36	404.9	382.79		
407.24	381.58	408.71	381.19	409.96	380.62	411.3	380.16	413.29	379.47		
416.67	383.16	417.59	383.99	418.97	384.41	431.05	389.28	445.8	391.99		
447.31	392.24	447.55	392.24	453.37	391.68	456.47	391.66	459.59	391.65		
465.05	391.59	468.06	391.57	471.08	391.56	474.11	391.54	477.23	391.21		
483.51	391.19	486.91	391.48	488.19	391.02	496.31	391.12	498.59	391.29		
507.13	391.32	513	391.34	513.45	391.34	520.99	390.04	525.13	388.76		
531.7	388.05	540.2	387.59	549.18	389.04	553.44	389.63	556.09	389.79		
560.52	389.79	565.36	390.2	567.6	390.88	569.66	390.64	574.68	391.05		
580.14	391.61	581.76	391.76	583.48	391.79	592.18	391.72	594.43	391.92		
602.6	392.56	607.86	392.99	611.14	393.26	613.07	393.39	617.08	393.67		
625.17	394.22	635.19	394.48	641.38	394.61	643.87	394.64	646.96	394.7		
650.32	394.66	656.53	394.68	664.68	394.74	666.69	394.72	668.88	394.73		
673.76	394.67	678.25	394.73	680.84	394.72	683.66	395	687.92	395.16		
691.82	394.99	695	394.74	698.45	394.86	702.07	394.91	705.4	395		
709.15	395	713.24	395.13	716.23	395.22	718.97	395.15	723.31	395.03		
728.03	394.85	730.38	394.74	732.54	394.76	737.46	394.71	742.82	394.95		
744.54	394.97	746.12	394.96	751.62	394.77	757.61	394.88	759.26	394.89		
759.75	394.88	760.82	394.87	769.65	394.76	773.63	394.75	776.66	394.74		
779.45	394.94	781.86	395.03	786.98	395.32	789.81	395.48	799.94	396.04		
800.42	396.06	801.16	396.11	801.97	396.17	813.99	396.97	816.76	397.19		
827.56	398										

Manning's n Values num= 3  
 Sta n Val Sta n Val

Bridge\_Deck\_Adjustm.rep

0 .055 389.98

.035 431.05 .055

Bank Sta: Left Right Lengths: Left Channel Right Coeff Contr. Expan.  
 389.98 431.05 78.37 78.37 78.37 .1 .3

CROSS SECTION

RIVER: Little Goldstrea  
 REACH: Stream Centerlin RS: 181.45

INPUT

Description: Most Downstream Cross Section

Station	Elevation	Data	num=	233	Sta	Elev	Sta	Elev	Sta	Elev	Sta	Elev
0	390.2	580017	390.149	110046	390.5813	65002	390.617	68005	390.62			
27.55005	390.6628	59003	390.67	28.75	390.6729	41003	390.6731	06006	390.66			
37.01001	390.5841	33002	390.644	17004	390.5948	10004	390.6251	33002	390.63			
53.68005	390.7158	49005	390.83	65.13	391.0765	65002	391.0766	03003	391.08			
72.81006	391.17	78.38	391.2779	97003	391.2882	17004	391.2387	14001	391.16			
90.73004	391.2894	30005	391.4899	21002	391.5	101.46	391.53	103.08	391.53			
113.28	391.89115	4301	391.97	115.78	391.98	116.25	391.98	122.94	392.03			
127.78	392.07	130.1	392.13	133.29	392.23	137.26	392.37	140.13	392.44			
144.42	392.52	150.33	392.61	151.58	392.64152	4901	392.66158	7401	392.66			
164.84	392.71	165.9	392.74167	3701	392.75173	0601	392.8	177.19	392.94			
180.22	392.98	184.41	393.32	187.38	393.5	189.54	393.55	194.54	393.43			
201.45	393.62	201.7	393.62	201.89	393.63	208.86	394.01214	2401	394.1			
216.02	394.08	219.3	393.9	223.46	393.74	234.1	393.31235	0601	393.4			
251.29	394.49252	5601	394.46	263.64	394.58	267.08	394.65	267.67	394.64			
278.39	395.08	280.72	395.24	282.6	395.36	284.8	395.51	294.6	395.76			
296.3701	396.02	298.42	396.12	302.25	396.32	302.56	396.33	304.06	396.36			
307.01	396.52	312.83	396.8	315.48	396.69	320.36	396.79	322.14	396.69			
326.09	396.74	327.53	396.64	328.8	396.55	329.85	396.55	333.51	396.27			
336.6	396.13	341.81	395.78	342.08	395.77	343.17	395.69	348.25	395.19			
359.78	393.84	360.23	393.77	360.64	393.73	360.87	393.7	368.35	392.15			
370.59	391.89	371.26	391.81	371.8	391.77	380.14	391.43	380.67	391.39			
381.61	391.32	383.27	391.2	386.1	391	387.65	390.88	393.2	389.93			
393.37	389.92	396.52	389.75	401.15	389.77	402.94	389.65	405.07	389.52			
405.73	389.47	411.8	389.08	412.21	389.05	414.74	388.88	416.72	388.67			
416.93	388.66	417.1	388.66	420.78	388.49	438.79	378.76	439.1	378.83			
439.26	378.93	439.28	378.94	439.36	378.97	439.38	378.98	439.54	379.04			
439.74	379.12	439.78	379.14	440.01	379.23	440.11	379.29	440.4	379.46			
440.45	379.49	440.48	379.51	453.46	387.32	454.73	388.08	454.8	388.09			
456.61	388.36	466.2	389.39	467.4	389.53	467.57	389.55	474.66	389.81			
480.85	390.38	482.47	390.39	483.72	390.36	493.02	390.16	495.17	390.49			
499.43	391.16	502.16	391.45	504.39	391.69	515.67	392.78	520.29	393.34			
520.79	393.3	524.35	393.1	527.36	393.03	531.52	392.77	537.34	392.45			
538.6901	392.46	539.65	392.53	545.85	392.91551	9401	393.15	553.49	393.34			
554.54	393.32561	7401	393.62	564.71	393.68	572.21	393.83	578.12	394.02			
579.0601	394.02	584.77	394.08	589.26	394	590.59	393.99592	9901	393.96			
599.32	393.87603	5601	393.83	607.14	393.79609	3101	393.83	610.22	393.85			
615.38	393.94	619.01	394.01	623.95	394.19	626.25	394.24	628.77	394.3			
637.66	394.78	638.16	394.79	638.51	394.8	640.55	394.76	646.21	394.34			
650.26	394.32	653.38	394.24	657.76	394.25	660.55	394.22	662.54	394.24			
670.42	394.01	674.55	393.72	676.37	393.59	679.72	393.64	681.77	393.7			
692.23	393.91	707.58	394.2	710.73	394.31	711.7	394.38	717.55	394.51			
723.72	394.68	724.66	394.7	730.41	394.75	730.96	394.75	735.26	394.89			
735.82	394.9	735.91	394.9	741.07	395.02	745.42	395.12	749.15	395.21			
752.04	395.38756	1201	395.49	759.35	395.57	762.84	395.67	765.82	395.75			
772.28	395.83774	7401	395.9	774.86	395.9	775.88	395.93	785.78	396.48			
787.5	396.54789	1201	396.58	790.63	396.63	799.59	397.05	801.59	397.11			
809.8	397.96810	3101	397.98	810.78	398							

Manning's n Values		num= 3		Bridge_Deck_Adjustm. rep	
Sta	n Val	Sta	n Val	Sta	n Val
0	.055	420.78	.035	454.73	.055
Bank Sta: Left	Right	Lengths: Left	Channel	Right	Coeff
420.78	454.73	0	0	0	.1
Left Levee	Station=	320.36	Elevation=	396.79	Expan.
Right Levee	Station=	637.66	Elevation=	394.78	.3

SUMMARY OF MANNING'S N VALUES

River: Little Goldstrea

Reach	River Sta.	n1	n2	n3
Stream Centerlin	640.59	.055	.035	.055
Stream Centerlin	583.05	.055	.035	.055
Stream Centerlin	527.1	.055	.035	.046
Stream Centerlin	497.46	.046	.035	.046
Stream Centerlin	450	Bridge		
Stream Centerlin	434.05	.046	.035	.046
Stream Centerlin	376.11	.055	.035	.055
Stream Centerlin	317.52	.055	.035	.055
Stream Centerlin	259.82	.055	.035	.055
Stream Centerlin	181.45	.055	.035	.055

SUMMARY OF REACH LENGTHS

River: Little Goldstrea

Reach	River Sta.	Left	Channel	Right
Stream Centerlin	640.59	57.54	57.54	57.54
Stream Centerlin	583.05	55.95	55.95	55.95
Stream Centerlin	527.1	272.34	272.34	272.34
Stream Centerlin	497.46	63.41	63.41	63.41
Stream Centerlin	450	Bridge		
Stream Centerlin	434.05	60	60	60
Stream Centerlin	376.11	58.59	58.59	58.59
Stream Centerlin	317.52	57.7	57.7	57.7
Stream Centerlin	259.82	78.37	78.37	78.37
Stream Centerlin	181.45	0	0	0

SUMMARY OF CONTRACTION AND EXPANSION COEFFICIENTS

River: Little Goldstrea

Reach	River Sta.	Contr.	Expan.
Stream Centerlin	640.59	.1	.3
Stream Centerlin	583.05	.1	.3
Stream Centerlin	527.1	.2	.4
Stream Centerlin	497.46	.3	.5
Stream Centerlin	450	Bridge	
Stream Centerlin	434.05	.3	.5

		Bridge_Deck_Adjustm. rep	
Stream Centerlin	376.11	.2	.4
Stream Centerlin	317.52	.1	.3
Stream Centerlin	259.82	.1	.3
Stream Centerlin	181.45	.1	.3